

# **RIGOL**

## **User's Guide**

### **DS2000E Series Digital Oscilloscope**

**Oct. 2017**

**RIGOL TECHNOLOGIES, INC.**



# Guaranty and Declaration

## Copyright

© 2017 **RIGOL** TECHNOLOGIES, INC. All Rights Reserved.

## Trademark Information

**RIGOL** is a registered trademark of **RIGOL** TECHNOLOGIES, INC.

## Publication Number

UGA23102-1110

## Software Version

00.03.05.SP3

Software upgrade might change or add product features. Please acquire the latest version of the manual from **RIGOL** website or contact **RIGOL** to upgrade the software.

## Notices

- **RIGOL** products are covered by P.R.C. and foreign patents, issued and pending.
- **RIGOL** reserves the right to modify or change parts of or all the specifications and pricing policies at the company's sole decision.
- Information in this publication replaces all previously released materials.
- Information in this publication is subject to change without notice.
- **RIGOL** shall not be liable for either incidental or consequential losses in connection with the furnishing, use, or performance of this manual, as well as any information contained.
- Any part of this document is forbidden to be copied, photocopied, or rearranged without prior written approval of **RIGOL**.

## Product Certification

**RIGOL** guarantees that this product conforms to the national and industrial standards in China as well as the ISO9001:2008 standard and the ISO14001:2004 standard. Other international standard conformance certifications are in progress.

## Contact Us

If you have any problem or requirement when using our products or this manual, please contact **RIGOL**.

E-mail: [service@rigol.com](mailto:service@rigol.com)

Website: [www.rigol.com](http://www.rigol.com)

# Safety Requirement

## General Safety Summary

Please review the following safety precautions carefully before putting the instrument into operation so as to avoid any personal injury or damage to the instrument and any product connected to it. To prevent potential hazards, please follow the instructions specified in this manual to use the instrument properly.

### **Use Proper Power Cord.**

Only the exclusive power cord designed for the instrument and authorized for use within the local country could be used.

### **Ground the Instrument.**

The instrument is grounded through the Protective Earth lead of the power cord. To avoid electric shock, connect the earth terminal of the power cord to the Protective Earth terminal before connecting any input or output terminals.

### **Connect the Probe Correctly.**

If a probe is used, the probe ground lead must be connected to earth ground. Do not connect the ground lead to high voltage. Improper way of connection could result in dangerous voltages being present on the connectors, controls or other surfaces of the oscilloscope and probes, which will cause potential hazards for operators.

### **Observe All Terminal Ratings.**

To avoid fire or shock hazard, observe all ratings and markers on the instrument and check your manual for more information about ratings before connecting the instrument.

### **Use Proper Overvoltage Protection.**

Ensure that no overvoltage (such as that caused by a bolt of lightning) can reach the product. Otherwise, the operator might be exposed to the danger of an electric shock.

**Do Not Operate Without Covers.**

Do not operate the instrument with covers or panels removed.

**Do Not Insert Objects Into the Air Outlet.**

Do not insert objects into the air outlet, as doing so may cause damage to the instrument.

**Use Proper Fuse.**

Please use the specified fuses.

**Avoid Circuit or Wire Exposure.**

Do not touch exposed junctions and components when the unit is powered on.

**Do Not Operate With Suspected Failures.**

If you suspect that any damage may occur to the instrument, have it inspected by **RIGOL** authorized personnel before further operations. Any maintenance, adjustment or replacement especially to circuits or accessories must be performed by **RIGOL** authorized personnel.

**Provide Adequate Ventilation.**

Inadequate ventilation may cause an increase of temperature in the instrument, which would cause damage to the instrument. So please keep the instrument well ventilated and inspect the air outlet and the fan regularly.

**Do Not Operate in Wet Conditions.**

To avoid short circuit inside the instrument or electric shock, never operate the instrument in a humid environment.

**Do Not Operate in an Explosive Atmosphere.**

To avoid personal injuries or damage to the instrument, never operate the instrument in an explosive atmosphere.

**Keep Instrument Surfaces Clean and Dry.**

To avoid dust or moisture from affecting the performance of the instrument, keep the surfaces of the instrument clean and dry.

**Prevent Electrostatic Impact.**

Operate the instrument in an electrostatic discharge protective environment to avoid damage induced by static discharges. Always ground both the internal and external conductors of cables to release static before making connections.

**Use the Battery Properly.**

Do not expose the battery (if available) to high temperature or fire. Keep it out of the reach of children. Improper change of a battery (lithium battery) may cause an explosion. Use the **RIGOL** specified battery only.

**Handle with Caution.**

Please handle with care during transportation to avoid damage to keys, knobs, interfaces, and other parts on the panels.

## Safety Terms and Symbols

### Safety Notices in this Manual:

**WARNING**

Indicates a potentially hazardous situation or practice which, if not avoided, will result in serious injury or death.

**CAUTION**

Indicates a potentially hazardous situation or practice which, if not avoided, could result in damage to the product or loss of important data.

### Safety Terms on the Product:

**DANGER** It calls attention to an operation, if not correctly performed, could result in injury or hazard immediately.

**WARNING** It calls attention to an operation, if not correctly performed, could result in potential injury or hazard.

**CAUTION** It calls attention to an operation, if not correctly performed, could result in damage to the product or other devices connected to the product.

### Safety Symbols on the Product:



Hazardous  
Voltage



Safety  
Warning



Protective  
Earth  
Terminal



Chassis  
Ground



Test  
Ground

## Allgemeine Sicherheits Informationen

Überprüfen Sie die folgenden Sicherheitshinweise sorgfältig um Personenschäden oder Schäden am Gerät und an damit verbundenen weiteren Geräten zu vermeiden. Zur Vermeidung von Gefahren, nutzen Sie bitte das Gerät nur so, wie in diesem Handbuch angegeben.

### **Um Feuer oder Verletzungen zu vermeiden, verwenden Sie ein ordnungsgemäßes Netzkabel.**

Verwenden Sie für dieses Gerät nur das für ihr Land zugelassene und genehmigte Netzkabel.

### **Erden des Gerätes.**

Das Gerät ist durch den Schutzleiter im Netzkabel geerdet. Um Gefahren durch elektrischen Schlag zu vermeiden, ist es unerlässlich, die Erdung durchzuführen. Erst dann dürfen weitere Ein- oder Ausgänge verbunden werden.

### **Anschluss eines Tastkopfes.**

Die Erdungsklemmen der Sonden sind auf dem gleichen Spannungspegel des Instruments geerdet. Schließen Sie die Erdungsklemmen an keine hohe Spannung an.

### **Beachten Sie alle Anschlüsse.**

Zur Vermeidung von Feuer oder Stromschlag, beachten Sie alle Bemerkungen und Markierungen auf dem Instrument. Befolgen Sie die Bedienungsanleitung für weitere Informationen, bevor Sie weitere Anschlüsse an das Instrument legen.

### **Verwenden Sie einen geeigneten Überspannungsschutz.**

Stellen Sie sicher, daß keinerlei Überspannung (wie z.B. durch Gewitter verursacht) das Gerät erreichen kann. Andernfalls besteht für den Anwender die Gefahr eines Stromschlages.

### **Nicht ohne Abdeckung einschalten.**

Betreiben Sie das Gerät nicht mit entfernten Gehäuse-Abdeckungen.



**Betreiben Sie das Gerät nicht geöffnet.**

Der Betrieb mit offenen oder entfernten Gehäuseteilen ist nicht zulässig. Nichts in entsprechende Öffnungen stecken (Lüfter z.B.)

**Passende Sicherung verwenden.**

Setzen Sie nur die spezifikationsgemäßen Sicherungen ein.

**Vermeiden Sie ungeschützte Verbindungen.**

Berühren Sie keine unisolierten Verbindungen oder Baugruppen, während das Gerät in Betrieb ist.

**Betreiben Sie das Gerät nicht im Fehlerfall.**

Wenn Sie am Gerät einen Defekt vermuten, sorgen Sie dafür, bevor Sie das Gerät wieder betreiben, dass eine Untersuchung durch **RIGOL** autorisiertem Personal durchgeführt wird. Jedwede Wartung, Einstellarbeiten oder Austausch von Teilen am Gerät, sowie am Zubehör dürfen nur von **RIGOL** autorisiertem Personal durchgeführt werden.

**Belüftung sicherstellen.**

Unzureichende Belüftung kann zu Temperaturanstiegen und somit zu thermischen Schäden am Gerät führen. Stellen Sie deswegen die Belüftung sicher und kontrollieren regelmäßig Lüfter und Belüftungsöffnungen.

**Nicht in feuchter Umgebung betreiben.**

Zur Vermeidung von Kurzschluß im Geräteinneren und Stromschlag betreiben Sie das Gerät bitte niemals in feuchter Umgebung.

**Nicht in explosiver Atmosphäre betreiben.**

Zur Vermeidung von Personen- und Sachschäden ist es unumgänglich, das Gerät ausschließlich fernab jedweder explosiven Atmosphäre zu betreiben.

**Geräteoberflächen sauber und trocken halten.**

Um den Einfluß von Staub und Feuchtigkeit aus der Luft auszuschließen, halten Sie bitte die Geräteoberflächen sauber und trocken.

**Schutz gegen elektrostatische Entladung (ESD).**

Sorgen Sie für eine elektrostatisch geschützte Umgebung, um somit Schäden und

Funktionsstörungen durch ESD zu vermeiden. Erden Sie vor dem Anschluß immer Innen- und Außenleiter der Verbindungsleitung, um statische Aufladung zu entladen.

**Die richtige Verwendung des Akku.**

Wenn eine Batterie verwendet wird, vermeiden Sie hohe Temperaturen bzw. Feuer ausgesetzt werden. Bewahren Sie es außerhalb der Reichweite von Kindern auf. Unsachgemäße Änderung der Batterie (Anmerkung: Lithium-Batterie) kann zu einer Explosion führen. Verwenden Sie nur von **RIGOL** angegebenen Akkus.

**Sicherer Transport.**

Transportieren Sie das Gerät sorgfältig (Verpackung!), um Schäden an Bedienelementen, Anschlüssen und anderen Teilen zu vermeiden.

## Sicherheits Begriffe und Symbole

### Begriffe in diesem Guide:



#### **WARNING**

Die Kennzeichnung WARNING beschreibt Gefahrenquellen die leibliche Schäden oder den Tod von Personen zur Folge haben können.



#### **CAUTION**

Die Kennzeichnung Caution (Vorsicht) beschreibt Gefahrenquellen die Schäden am Gerät hervorrufen können.

### Begriffe auf dem Produkt:

**DANGER** weist auf eine Verletzung oder Gefährdung hin, die sofort geschehen kann.

**WARNING** weist auf eine Verletzung oder Gefährdung hin, die möglicherweise nicht sofort geschehen.

**CAUTION** weist auf eine Verletzung oder Gefährdung hin und bedeutet, dass eine mögliche Beschädigung des Instruments oder anderer Gegenstände auftreten kann.

### Symbole auf dem Produkt:



Gefährliche  
Spannung



Sicherheits-  
Hinweis



Schutz-erde



Gehäusemasse



Erde

# Measurement Category

## Measurement Category

DS2000E series digital oscilloscopes can make measurements in Measurement Category I.



---

### **WARNING**

This oscilloscope can only be used for measurements within its specified measurement categories.

---

## Measurement Category Definitions

Measurement category I is for measurements performed on circuits not directly connected to MAINS. Examples are measurements on circuits not derived from MAINS, and specially protected (internal) MAINS derived circuits. In the latter case, transient stresses are variable; for that reason, the transient withstand capability of the equipment is made known to the user.

Measurement category II is for measurements performed on circuits directly connected to the low voltage installation. Examples are measurements on household appliances, portable tools and similar equipment.

Measurement category III is for measurements performed in the building installation. Examples are measurements on distribution boards, circuit-breakers, wiring, including cables, bus-bars, junction boxes, switches, socket-outlets in the fixed installation, and equipment for industrial use and some other equipment, for example. Stationary motors with permanent connection to the fixed installation.

Measurement category IV is for measurements performed at the source of the low-voltage installation. Examples are electricity meters and measurements on primary overcurrent protection devices and ripple control units.

---

## Ventilation Requirement

This oscilloscope uses fan to force cooling. Please make sure that the air intake and exhaust areas are free from obstructions and have free air. When using the oscilloscope in a bench-top or rack setting, provide at least 10 cm clearance beside, above and behind the instrument for adequate ventilation.



---

### **WARNING**

Inadequate ventilation may cause temperature increase which would damage the instrument. So please keep the instrument well ventilated during operation and inspect the intake and fan regularly.

---

## Working Environment

### Temperature

Operating: 0°C to +50°C

Non-operating: -40°C to +70°C

### Humidity

0°C to +30°C: ≤95%RH

+30°C to +40°C: ≤75%RH

+40°C to +50°C: ≤45%RH



#### **WARNING**

To avoid short circuit inside the instrument or electric shock, never operate the instrument in a humid environment.

---

### Altitude

Operating: below 3 km

Non-operating: below 15 km

### Installation (Overvoltage) Category

This product is powered by mains conforming to installation (overvoltage) category II.



#### **WARNING**

Ensure that no overvoltage (such as that caused by a bolt of lightning) can reach the product. Otherwise, the operator might be exposed to the danger of an electric shock.

---

### Installation (Overvoltage) Category Definitions

Installation (overvoltage) category I refers to signal level which is applicable to equipment measurement terminals connected to the source circuit. Among these terminals, precautions are done to limit the transient voltage to a low level.

Installation (overvoltage) category II refers to the local power distribution level which is applicable to equipment connected to the AC line (AC power).

**Pollution Degree**

Degree 2

**Pollution Degree Definitions**

Pollution Degree 1: No pollution or only dry, nonconductive pollution occurs. The pollution has no effect. For example, a clean room or air-conditioned office environment.

Pollution Degree 2: Normally only nonconductive pollution occurs. Temporary conductivity caused by condensation is to be expected. For example, indoor environment.

Pollution Degree 3: Conductive pollution or dry nonconductive pollution that becomes conductive due to condensation occurs. To be found in industrial environment or construction sites (harsh environments). For example, sheltered outdoor environment.

Pollution Degree 4: The pollution generates persistent conductivity caused by conductive dust, rain, or snow. For example, outdoor areas.

**Safety Class**

Class 1 – Grounded Product

## Care and Cleaning

### Care

Do not store or leave the instrument where it may be exposed to direct sunlight for long periods of time.

### Cleaning

Clean the instrument regularly according to its operating conditions.

1. Disconnect the instrument from all power sources.
2. Clean the external surfaces of the instrument with a soft cloth dampened with mild detergent or water. When cleaning the LCD, take care to avoid scarifying it.



#### **CAUTION**

To avoid damage to the instrument, do not expose it to caustic liquids.

---



#### **WARNING**

To avoid short-circuit resulting from moisture or personal injuries, ensure that the instrument is completely dry before reconnecting it to the power supply.

---



---

## Environmental Considerations

The following symbol indicates that this product complies with the WEEE Directive 2002/96/EC.



### Product End-of-Life Handling

The equipment may contain substances that could be harmful to the environment or human health. To avoid the release of such substances into the environment and avoid harm to human health, we recommend you to recycle this product appropriately to ensure that most materials are reused or recycled properly. Please contact your local authorities for disposal or recycling information.

# DS2000E Series Overview

Based on our UltraVision technology, the DS2000E delivers advanced performance and analysis capabilities, a large intensity graded display, and a proven and reliable hardware platform at an unprecedented price point. Engineers and technicians needing higher performance test solutions for more advanced debug tasks will appreciate the unique price/performance attributes of the DS2000E.

## **Main features:**

### **The unique Ultra Vision technique**

- Real-time sample rate: up to 1 GSa/s per channel on both channels
- Memory depth: up to 28 Mpts per channel on both channels
- Waveform capture rate: 50,000 wfms/s (dots display)
- Real-time hardware waveform recording, playback and analysis functions; up to 65000 frames of waveforms can be recorded
- 256-level intensity grading display

### **Superb performance**

- Analog channel bandwidth: 200 MHz and 100 MHz
- Low base noise, 500  $\mu$ V/div to 10 V/div ultra-wide vertical dynamic range

### **Various functions**

- A variety of protocol triggers and decodes
- Various interfaces: USB Host, USB Device, LAN (LXI), AUX, and USB-GPIB (option)
- 29 waveform parameters auto measurement (with statistics)
- Fine delayed sweep function
- Built-in FFT function
- Pass/fail test function
- Conform to LXI Core 2011 Device class instrument standards; enable quick, economic, and efficient creation and reconfiguration of test system
- Support remote command control

### **User-friendly design**

- 8.0-inch WVGA (800\*480) 160,000 color TFT LCD, with ultra-wide screen, vivid picture, low power consumption, and long service life
- Adjustable waveform brightness

- Built-in help system
- Support multiple languages menu, Chinese/English interface, and Chinese/English input
- Novel and delicate industrial design and easier operation

# Document Overview

## **Main Topics of this Manual:**

Chapter 1 Quick Start	Introduces the preparations before using the oscilloscope and provides a basic introduction of the instrument.
Chapter 2 To Set the Vertical System	Introduces the vertical system functions of the oscilloscope.
Chapter 3 To Set the Horizontal System	Introduces the horizontal system functions of the oscilloscope.
Chapter 4 To Set the Sample System	Introduces the sample system functions of the oscilloscope.
Chapter 5 To Trigger the Oscilloscope	Introduces the trigger mode, trigger coupling, trigger holdoff, trigger source, and various trigger types of the oscilloscope.
Chapter 6 MATH and Measurements	Introduces how to make math operation, cursor measurement, and auto measurement.
Chapter 7 Protocol Decoding	Introduces how to decode the input signal by using those common protocols.
Chapter 8 Reference Waveform	Introduces how to compare the input waveform with the reference waveform.
Chapter 9 Pass/Fail Test	Introduces how to monitor the input signal by using the Pass/Fail test.
Chapter 10 Waveform Record	Introduces how to record waveforms, play back, and analyze the recorded waveforms.
Chapter 11 Display Control	Introduces how to control the display of the oscilloscope.
Chapter 12 Store and Recall	Introduces how to store and recall the setup file, the waveform file, etc.
Chapter 13 System Function Setting	Introduces how to set the remote interfaces and system-related functions.
Chapter 14 Remote Control	Introduces how to control the oscilloscope remotely.
Chapter 15 Troubleshooting	Introduces how to deal with the common failures of the oscilloscope.
Chapter 16 Specifications	Provides the technical specifications and general specifications of the oscilloscope.
Chapter 17 Appendix	Provides the basic information for the options and accessories.

## Format Conventions in this Manual:

### 1. Key

The key on the front panel is denoted by the format of "Key Name (Bold) + Text Box". For example, **Utility** denotes the "Utility" key.







### 2. Menu Softkey

The menu softkey is denoted by the format of "Menu Word (Bold) + Character Shading". For example, **System** denotes the "System" menu softkey under **Utility**.

### 3. Operation Step

The next step of operation is denoted by an arrow "→". For example, **Utility** → **System** denotes that first press **Utility** on the front panel first, and then press **System**.

### 4. Knob

Label	Knob	Label	Knob
<b>HORIZONTAL SCALE</b> 	Horizontal scale knob	<b>VERTICAL SCALE</b> 	Channel vertical scale knob
<b>HORIZONTAL POSITION</b> 	Horizontal position knob	<b>VERTICAL POSITION</b> 	Channel vertical position knob
<b>TRIGGER LEVEL</b> 	Trigger level knob		Multi-function knob

## Content Conventions in this Manual:

DS2000E series includes the following models. Unless otherwise specified, this manual takes DS2202E as an example to illustrate the functions and operation methods of the DS2000E series.

Model	Analog Bandwidth	Number of Channels
DS2102E	100 MHz	2
DS2202E	200 MHz	2



# Contents

<b>Guaranty and Declaration .....</b>	<b>I</b>
<b>Safety Requirement .....</b>	<b>II</b>
General Safety Summary .....	II
Safety Terms and Symbols .....	V
Allgemeine Sicherheits Informationen .....	VI
Sicherheits Begriffe und Symbole .....	IX
Measurement Category .....	X
Ventilation Requirement .....	XI
Working Environment .....	XII
Care and Cleaning .....	XIV
Environmental Considerations .....	XV
<b>DS2000E Series Overview .....</b>	<b>XVI</b>
<b>Document Overview .....</b>	<b>XVIII</b>
<b>Chapter 1 Quick Start .....</b>	<b>1-1</b>
General Inspection .....	1-2
Appearance and Dimensions .....	1-3
To Prepare the Oscilloscope for Use .....	1-4
To Adjust the Supporting Legs .....	1-4
To Connect to AC Power .....	1-4
Turn-on Checkout .....	1-5
To Connect the Probe .....	1-5
Function Inspection .....	1-6
Probe Compensation .....	1-7
Front Panel Overview .....	1-8
Rear Panel Overview .....	1-10
Front Panel Function Overview .....	1-12
VERTICAL .....	1-12
HORIZONTAL .....	1-13
TRIGGER .....	1-14
CLEAR .....	1-15
RUN/STOP .....	1-15
SINGLE .....	1-15

AUTO .....	1-15
Multi-function Knob.....	1-16
Navigation Knob .....	1-16
Function Keys.....	1-17
Record.....	1-18
Print.....	1-18
User Interface.....	1-19
To Use the Security Lock.....	1-23
To Use the Built-in Help System .....	1-24
<b>Chapter 2 To Set the Vertical System .....</b>	<b>2-1</b>
To Enable the Analog Channel .....	2-2
Channel Coupling .....	2-3
Bandwidth Limit .....	2-3
Probe Ratio .....	2-4
Input Impedance .....	2-5
Waveform Invert .....	2-5
Vertical Scale .....	2-6
Vertical Expansion .....	2-7
Amplitude Unit .....	2-7
Channel Label.....	2-7
Delay Calibration.....	2-9
<b>Chapter 3 To Set the Horizontal System.....</b>	<b>3-1</b>
Delayed Sweep .....	3-2
Time Base Mode .....	3-4
Y-T Mode .....	3-4
X-Y Mode .....	3-4
Roll Mode .....	3-7
Horizontal Scale .....	3-8
Horizontal Reference .....	3-9
<b>Chapter 4 To Set the Sample System.....</b>	<b>4-1</b>
Acquisition Mode.....	4-2
Normal .....	4-2
Average.....	4-2
Peak Detect .....	4-4
High Resolution .....	4-4
Sample Mode.....	4-5



Sample Rate .....	4-6
Memory Depth .....	4-8
Anti-Aliasing .....	4-9
<b>Chapter 5 To Trigger the Oscilloscope.....</b>	<b>5-1</b>
Trigger Source .....	5-2
Trigger Mode .....	5-3
Trigger Coupling .....	5-4
Trigger Holdoff .....	5-5
Noise Rejection .....	5-6
Trigger Type .....	5-7
Edge Trigger .....	5-8
Pulse Trigger .....	5-10
Runt Trigger .....	5-12
Windows Trigger (Option) .....	5-15
Nth Edge Trigger (Option) .....	5-17
Slope Trigger .....	5-19
Video Trigger (HDTV Option) .....	5-22
Pattern Trigger .....	5-25
Delay Trigger (Option) .....	5-27
TimeOut Trigger (Option) .....	5-30
Duration Trigger (Option) .....	5-32
Setup/Hold Trigger .....	5-33
RS232 Trigger .....	5-35
I2C Trigger .....	5-37
SPI Trigger .....	5-41
USB Trigger (Option) .....	5-43
CAN Trigger (Option) .....	5-45
Trigger Output Connector .....	5-48
<b>Chapter 6 MATH and Measurements .....</b>	<b>6-1</b>
Math Operation .....	6-2
Addition .....	6-2
Subtraction .....	6-2
Multiplication .....	6-3
Division .....	6-3
FFT .....	6-4
Digital Filter .....	6-7

Logic Operation .....	6-9
Advanced Operation.....	6-10
MATH Label.....	6-13
Auto Measurement .....	6-14
Quick Measurement after AUTO .....	6-14
One-key Measurement of 29 Parameters.....	6-16
Frequency Counter Measurement .....	6-22
Measurement Setting .....	6-23
To Clear the Measurement.....	6-26
All Measurement.....	6-27
Statistic Function .....	6-28
Measurement History .....	6-28
Cursor Measurement .....	6-29
Manual Mode .....	6-30
Track Mode .....	6-34
Auto Mode .....	6-36
X-Y Mode .....	6-37
<b>Chapter 7 Protocol Decoding .....</b>	<b>7-1</b>
Parallel Decoding .....	7-2
RS232 Decoding (Option) .....	7-5
I2C Decoding (Option).....	7-10
SPI Decoding (Option).....	7-14
CAN Decoding (Option).....	7-17
<b>Chapter 8 Reference Waveform.....</b>	<b>8-1</b>
To Enable REF Function .....	8-2
To Set the Color .....	8-2
To Select REF Source.....	8-2
To Save REF Waveform.....	8-3
To Adjust REF Waveform Display .....	8-3
To Export to Internal or External Memory .....	8-3
To Import from Internal or External Memory .....	8-4
<b>Chapter 9 Pass/Fail Test .....</b>	<b>9-1</b>
To Enable Pass/Fail Test.....	9-2
To Select Source .....	9-2
Mask Range.....	9-2
To Set Test Results Output Type .....	9-4

---

To Save the Test Mask .....	9-5
To Load the Test Mask .....	9-5
<b>Chapter 10 Waveform Record .....</b>	<b>10-1</b>
Waveform Record .....	10-2
Record Constant On .....	10-4
Waveform Playback .....	10-6
Waveform Analysis .....	10-8
Analysis Based on Trace .....	10-12
Analysis Based on Pass/Fail Mask .....	10-13
<b>Chapter 11 Display Control .....</b>	<b>11-1</b>
To Select the Display Type .....	11-2
To Set the Persistence Time .....	11-2
To Set the Waveform Intensity .....	11-4
To Set the Screen Grid .....	11-4
To Set the Grid Brightness .....	11-4
To Set the Menu Display .....	11-4
<b>Chapter 12 Store and Recall .....</b>	<b>12-1</b>
Storage System .....	12-2
Storage Type .....	12-3
Internal Storage and Recall .....	12-5
External Storage and Recall .....	12-7
Disk Management .....	12-9
To Select File Type .....	12-9
To Create a New File or Folder .....	12-10
To Delete a File or Folder .....	12-13
To Rename a File or Folder .....	12-14
To Clear the Local Memory .....	12-14
Factory .....	12-15
<b>Chapter 13 System Function Setting .....</b>	<b>13-1</b>
Remote Interface Configuration .....	13-2
LAN Setting .....	13-2
USB Device .....	13-7
GPIB Address .....	13-7
System-related .....	13-8
Sound .....	13-8

---

Language .....	13-8
System Information .....	13-9
Power-off Recall .....	13-9
System Time .....	13-10
Screen.....	13-11
Self-calibration .....	13-12
Print Setting.....	13-13
Power Status.....	13-15
Aux Output .....	13-16
Option Management .....	13-17
Auto Setting.....	13-19
<b>Chapter 14 Remote Control .....</b>	<b>14-1</b>
Remote Control via USB.....	14-2
Remote Control via LAN .....	14-6
Remote Control via GPIB.....	14-8
<b>Chapter 15 Troubleshooting .....</b>	<b>15-1</b>
<b>Chapter 16 Specifications.....</b>	<b>16-1</b>
<b>Chapter 17 Appendix.....</b>	<b>17-1</b>
Appendix A: Accessories and Options .....	17-1
Appendix B: Warranty.....	17-2
<b>Index.....</b>	<b>1</b>

# Chapter 1 Quick Start

This chapter introduces the precautions when using the oscilloscope for the first time, the front/rear panels of the oscilloscope, the user interface and the using method of the built-in help system.

The contents of this chapter:

- General Inspection
- Appearance and Dimensions
- To Prepare the Oscilloscope for Use
- Front Panel Overview
- Rear Panel Overview
- Front Panel Function Overview
- User Interface
- To Use the Security Lock
- To Use the Built-in Help System

## General Inspection

### 1. Inspect the packaging

If the packaging has been damaged, do not dispose the damaged packaging or cushioning materials until the shipment has been checked for completeness and has passed both electrical and mechanical tests.

The consigner or carrier shall be liable for the damage to the instrument resulting from shipment. **RIGOL** would not be responsible for free maintenance/rework or replacement of the instrument.

### 2. Inspect the instrument

In case of any mechanical damage, missing parts, or failure in passing the electrical and mechanical tests, contact your **RIGOL** sales representative.

### 3. Check the accessories

Please check the accessories according to the packing lists. If the accessories are damaged or incomplete, please contact your **RIGOL** sales representative.

# Appearance and Dimensions

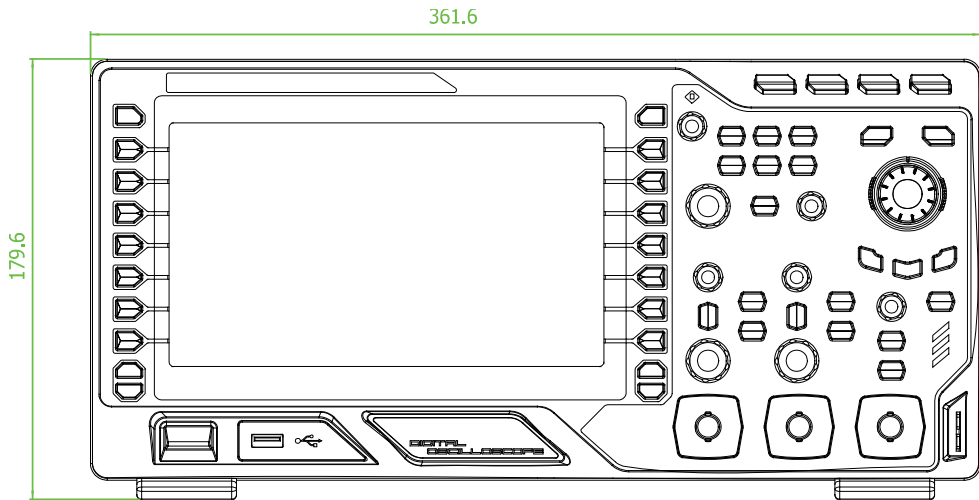

Figure 1-1 Front View

Unit: mm

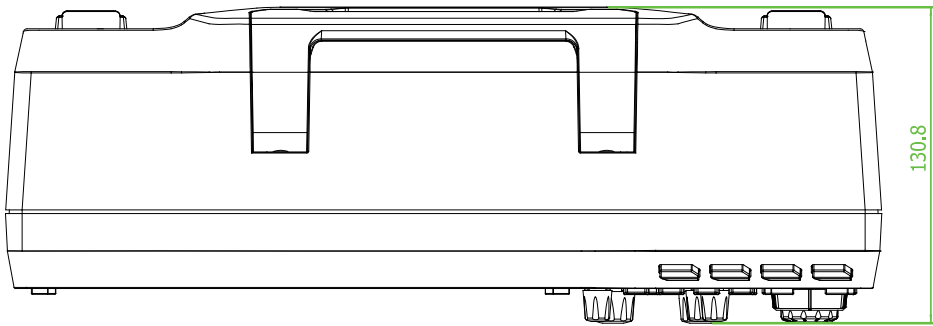

Figure 1-2 Vertical View

Unit: mm

## To Prepare the Oscilloscope for Use

### To Adjust the Supporting Legs

Adjust the supporting legs properly to use them as stands to tilt the oscilloscope upwards for stable placement of the oscilloscope as well as better operation and observation.

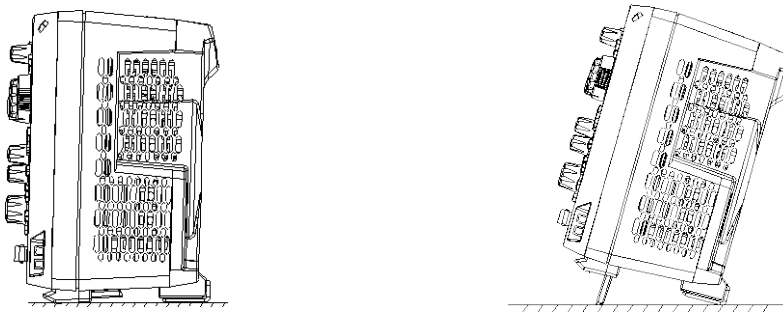



Figure 1-3 To Adjust the Supporting Legs

### To Connect to AC Power

The power requirements of the oscilloscope are 100-240 V, 45-440 Hz. Please use the power cord provided in the accessories to connect the oscilloscope to the AC power source, as shown in the figure below. When the oscilloscope is connected to power, the Power key  located at the lower-left corner of the front panel is blinking.

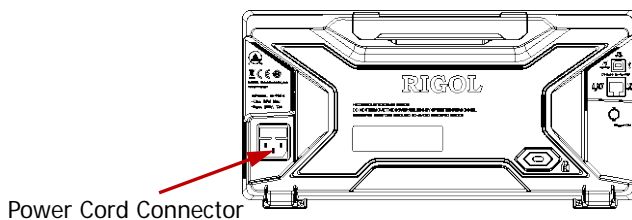



Figure 1-4 To Connect to AC Power



## Turn-on Checkout

When the oscilloscope is connected to power, press the Power key  at the lower-left corner of the front panel to start the oscilloscope if the power status is currently set to "Default"; if the power status is currently set to "Open", the oscilloscope starts automatically, and you do not have to press down the Power key. During the start-up process, the oscilloscope performs a series of self-tests. You can hear the switching sound of the relay. After the self-test, the welcome screen is displayed. The instrument is installed with the trial versions of the options before leaving factory. Its remaining trial time is about 2,000 minutes. The "Installed Options" dialog box will be displayed if your instrument currently installs the trial versions of the options. From this dialog box, you can view the option type, option name, option edition, and the remaining trial time of the option currently installed.

## To Connect the Probe

**RIGOL** provides passive probes for DS2000E. For detailed technical information of the probes, please refer to the corresponding Probe User's Guide.

### Connect the passive probe:

1. Connect the BNC terminal of the probe to an analog channel input terminal of the oscilloscope on the front panel.
2. Connect the ground alligator clip or the ground spring of the probe to the circuit ground terminal and connect the probe tip to the circuit point to be tested.

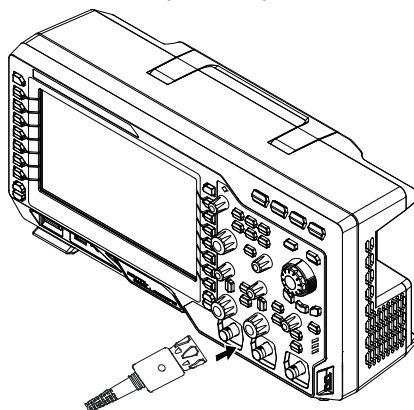

Figure 1-5 To Connect the Passive Probe

## Function Inspection

1. Press **Storage** → **Default** to restore the oscilloscope to its factory state.
2. Connect the ground alligator clip of the probe to the "Ground Terminal" as shown in the figure below.
3. Connect one end of the probe to CH1 input terminal of the oscilloscope, and connect the other end to the "Probe Compensation Signal Output Terminal".

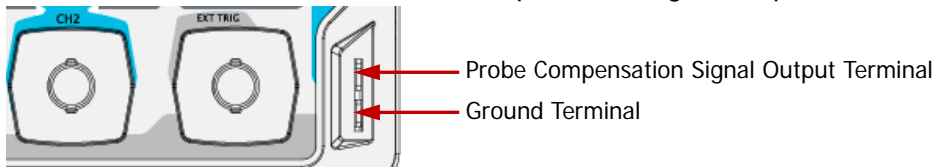

Figure 1-6 Probe Compensation Signal Output Terminal/Ground Terminal

4. Set the probe attenuation to 10X, and then press **AUTO**.
5. Observe the waveform on the display. If the waveforms actually shown do not match that in the figure below, please perform "**Probe Compensation**".

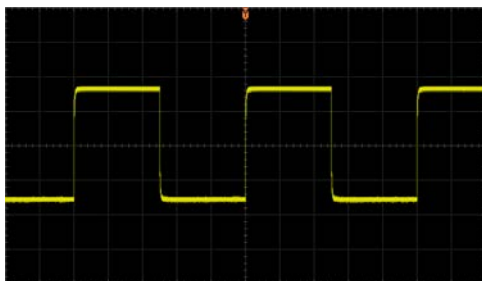

Figure 1-7 Probe Compensation Signal

6. Use the same method to test the other channels.



### WARNING

To avoid electric shock when using the probe, please make sure that the insulated wire of the probe is in good condition. Do not touch the metallic part of the probe when the probe is connected to high voltage source.

### Tip

The probe compensation signal can only be used for probe compensation adjustment and cannot be used for calibration.

## Probe Compensation

When the probe is used for the first time or when the probe compensation signal does not match that shown in Figure 1-7, you should compensate the probe to match the input channel of the oscilloscope. The non-compensated or poorly compensated probe may cause measurement errors. The probe compensation procedures are as follows:

1. Perform Step 1, 2, 3, and 4 in "**Function Inspection**".
2. Check the displayed waveforms and compare them with the following figures.

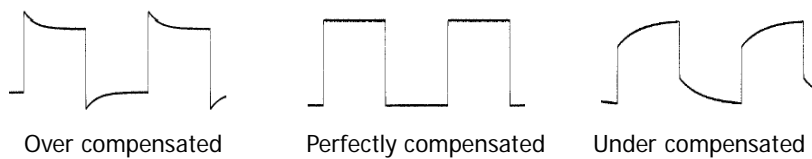

Figure 1-8 Probe Compensation

3. Use a nonmetallic driver to adjust the low-frequency compensation adjustment hole on the probe until the waveform is displayed as "Perfectly compensated" in the figure above.

# Front Panel Overview

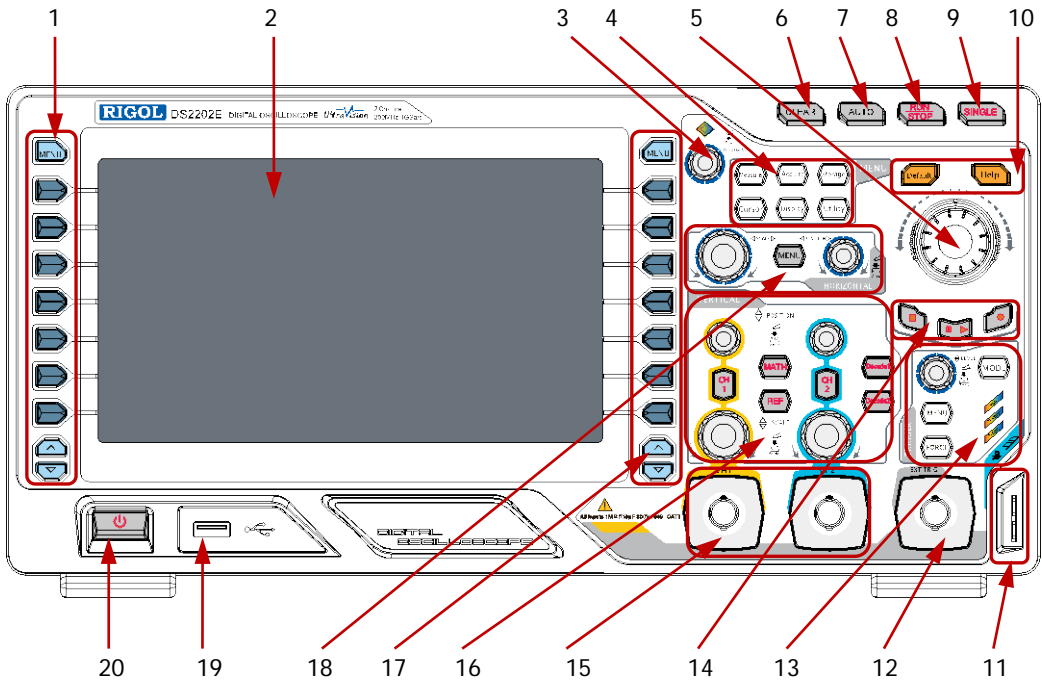

Figure 1-9 Front Panel

Table 1-1 Front Panel Description

No.	Description	No.	Description
1	Measurement menu softkeys	11	Probe compensation signal output terminal and ground terminal
2	LCD	12	External trigger signal input terminal <sup>[1]</sup>
3	Multi-function knob	13	Trigger control area
4	Function keys	14	Waveform recording/playback keys
5	Navigation knob	15	Analog channel input terminals
6	Clear key	16	Vertical control area
7	AUTO key	17	Function menu softkeys
8	Run/Stop key	18	Horizontal control area
9	Single trigger control key	19	USB HOST interface
10	Help/Print key	20	Power key

**Note**<sup>[1]</sup>: The input impedance of the channel is fixed to be "high impedance".

## Rear Panel Overview

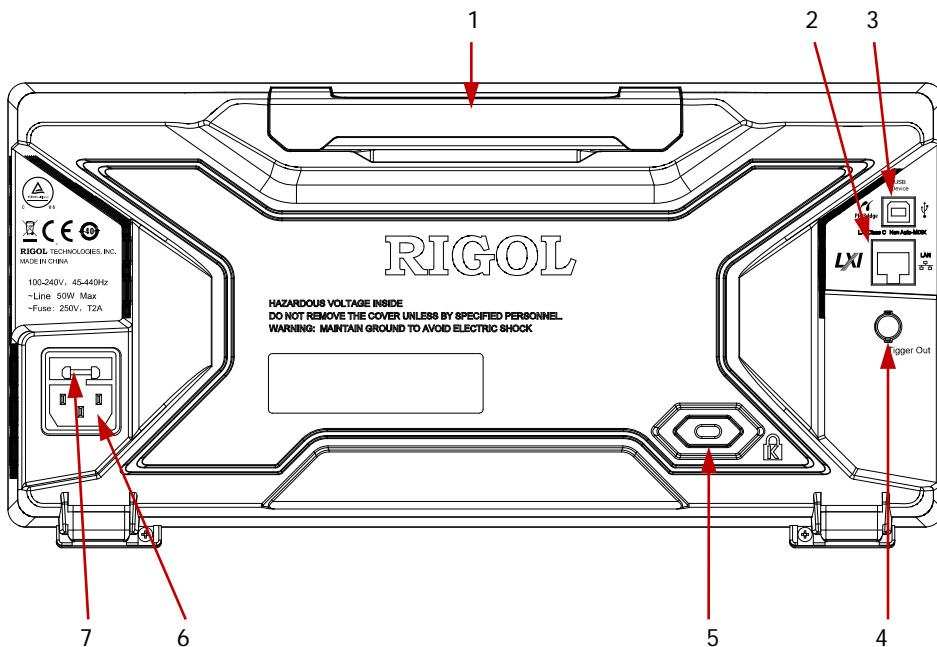

Figure 1-10 Rear Panel

### 1. Handle

Rotate the handle upright to carry the instrument easily. Rotate it downward if you do not need to carry it.

### 2. LAN

Connect the instrument to network via this interface for remote control. The instrument is in compliance with the standards specified in LXI Core 2011 Device. It can be used to set up a test system with other standard devices.

### 3. USB Device

A PictBridge printer can be connected via this interface to perform the print operation, and a PC can be connected via this interface to control the instrument with the PC software.

### 4. Trigger Out and Pass/Fail

- **Trig Out:**

A signal which reflects the current oscilloscope capture rate can be output

after one trigger is generated. If this signal is connected to a waveform display device to measure the frequency, the measurement result is the same as the current capture rate.

- **Pass/Fail:**

The instrument can output a negative pulse via this connector when a failed waveform is detected during the pass/fail test. The instrument continuously outputs a low level via this connector when no failed waveform is detected.

## 5. Lock Hole

You can lock the instrument to a fixed location by using the security lock (please purchase it by yourself) via the lock hole.

## 6. AC Power Cord Connector

The power supply requirements of the instrument are: 100-240 V, 45-440 Hz. Use the power cord provided with the accessories to connect the instrument to AC power. Then, you can press the Power key on the front panel to start the instrument.

## 7. Fuse

If you need to replace the fuse, use only the specified fuse. The fuse rating of the oscilloscope is 250 V, T2 A. To replace the fuse, perform the following procedures:

- (1) Turn off the instrument, cut off the power, and remove the power cord.
- (2) Insert a slotted screwdriver into the slot of the fuse holder to pry it out.
- (3) Take out the fuse and replace it with a specified fuse. Then, install the fuse holder.

## Front Panel Function Overview

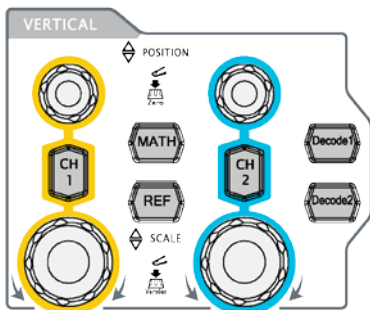

### VERTICAL





**CH1**, **CH2**: analog input channels. The 2 channels are marked by different colors which are also used to mark both the corresponding waveforms on the screen and the channel input connectors. Press any key to open the corresponding channel menu and press again to turn off the channel.

**MATH**: press this key to open the math operation menu. You can perform addition, subtraction, multiplication, division, FFT, digital filter, logic operations and advanced operations.

**REF**: press this key to enable the reference waveform function to compare the waveform actually measured with the reference waveform.

**VERTICAL**  **POSITION**: modify the vertical position of the current channel waveform. Turn clockwise to increase the position and turn counterclockwise to decrease. During the modification, the waveform would move up and down and the position message (e.g. ) at the lower-left corner of the screen would change accordingly. Press down this knob to quickly reset the vertical position to zero.

**VERTICAL**  **SCALE**: modify the vertical scale of the current channel. Turn clockwise to decrease the scale and turn counterclockwise to increase. During the modification, the display amplitude of the waveform would enlarge or reduce but the actual amplitude remains unchanged. The scale information (e.g. ) at the lower side of the screen would change accordingly. Press down this knob to quickly switch the vertical scale adjustment modes between "Coarse" and "Fine".



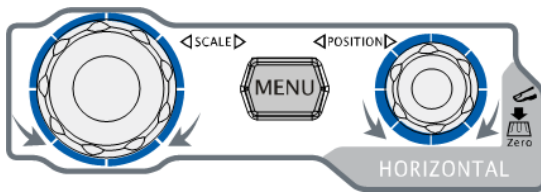

**Decode1**, **Decode2**: decoding function keys. Press the corresponding key to open the decoding function menu. DS2000E supports Parallel decoding and Protocol decoding.

## HORIZONTAL



**MENU**: press this key to open the horizontal control menu under which you can turn on or off the delayed sweep function, switch between different time base modes, switch between "Coarse" and "Fine" adjustment of scale as well as modify the horizontal reference setting.

**HORIZONTAL**  **SCALE**: modify the horizontal time base. Turn clockwise to reduce the time base and turn counterclockwise to increase. During the modification, waveforms of all the channels will be displayed in expanded or compressed mode and the time base message (e.g. **H 5.000ns**) at the upper side of the screen would change accordingly. Pressing down this knob can quickly turn on or off the delayed sweep function.

**HORIZONTAL**  **POSITION**: modify the horizontal position. The trigger point would move left or right relative to the center of the screen when you turn the knob. During the modification, waveforms of all the channels would move left or right and the trigger position message (e.g. **D 5.8000000ns**) at the upper-right corner of the screen would change accordingly. Pressing down this knob can quickly reset the trigger position (or the delayed sweep position).

## TRIGGER

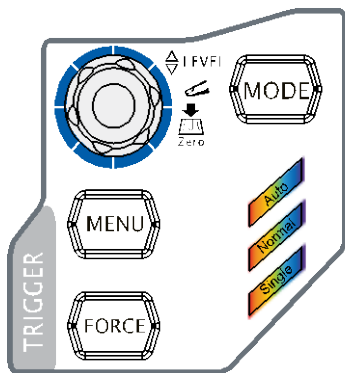

**MODE**: press this key to switch the trigger mode to **Auto**, **Normal** or **Single** and the corresponding state backlight of the current trigger mode would be illuminated.

**TRIGGER LEVEL**: modify the trigger level. Turn clockwise to increase the level and turn counterclockwise to reduce. During the modification, the trigger level line would move up

or down and the value in the trigger level message box (e.g. **Trig Level:1.88 V**) at the lower-left corner of the screen would change accordingly. Press down the knob to quickly reset the trigger level to zero point.

**MENU**: press this key to open the trigger operation menu. This oscilloscope provides various trigger types.

**FORCE**: in **Normal** and **Single** trigger modes, press this key to generate a trigger signal forcefully.

## CLEAR



Press this key to clear all the waveforms on the screen. If the oscilloscope is in the "RUN" state, new waveforms will still be displayed.

## RUN/STOP



Press this key to set the state of the oscilloscope to "RUN" or "STOP".

In the "RUN" state, the key is illuminated in yellow.  
In the "STOP" state, the key is illuminated in red.

## SINGLE



Press this key to set the trigger mode to "Single" and this key is illuminated in orange. In single trigger mode, press **FORCE** to generate a trigger signal immediately.

## AUTO



Press this key to enable the waveform auto setting function. The oscilloscope will automatically adjust the vertical scale, horizontal time base and trigger mode according to the input signal to realize optimum waveform display.

**Note:** The waveform auto setting function requires that the frequency of sine should be no lower than 25 Hz. If the parameter exceeds this limit, the waveform auto setting function might be invalid.

## Multi-function Knob

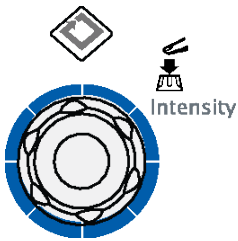

### Adjust waveform brightness:

In non-menu-operation mode (menu is hidden), turn this knob to adjust the brightness of waveform. The adjustable range is from 0% to 100%. Turn clockwise to increase the brightness and counterclockwise to reduce. Press down this knob to reset the brightness to 50%.

You can also press **Display** → **WaveIntensity** and use the knob to adjust the waveform brightness.

### Multi-function (the backlight goes on during operation):

In menu operation, press any menu softkey and turn the knob to select the submenus under this menu and then press down the knob to select the current submenu. It can also be used to modify parameters and input filename.

## Navigation Knob

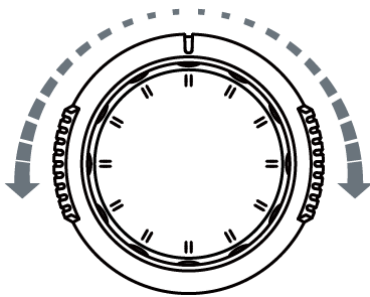

This knob can quickly adjust the numerical parameters with relatively large settable range. Turn clockwise (counterclockwise) to increase (reduce) the value. The inner knob is used for fine adjustment and the outer knob for coarse adjustment.

For example, this knob can be used to quickly locate the waveform frame (the **Current Frame** menu) to be played back in the waveform playback function. Similar parameters include trigger holdoff, pulse width setting, slope time and etc.

## Function Keys

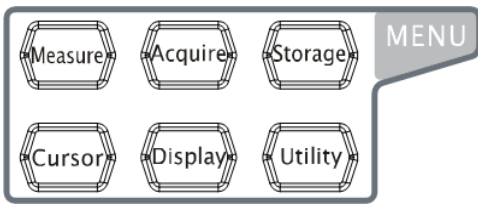

**Measure**: press this key to open the measurement setting menu. You can set the measurement setting, all measure, statistic function etc.

Press **MENU** at the left of the screen

to open the measurement menus of 29 waveform parameters. Then, press down the corresponding menu softkey to quickly realize one-key measurement and the measurement result will be displayed at the bottom of the screen.

**Acquire**: press this key to enter the sample setting menu to set the acquisition mode, memory depth and anti-aliasing function of the oscilloscope.

**Storage**: press this key to enter the file store and recall interface. The storable file types include traces, waveforms, setups, picture and CSV. The picture can be stored in bmp, png, jpeg or tiff format. Internal and external storage as well as disk management are also supported.

**Cursor**: press this key to enter the cursor measurement menu. The oscilloscope provides four cursor modes: manual, track, auto and X-Y.

**Note**: X-Y cursor mode is only available when the horizontal time base is set to X-Y.

**Display**: press this key to enter the display setting menu to set the display type, persistence time, wave intensity, grid type, grid brightness and menu display time of the waveform.

**Utility**: press this key to enter the system utility function setting menu to set the system-related functions or parameters, such as the I/O, sound and language. Besides, some advanced functions (such as the pass/fail test, waveform record and print setting) are also supported.

## Record

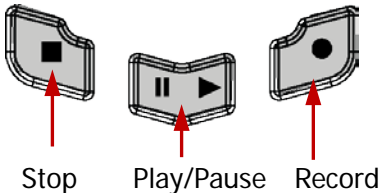

**Record:** press this key to start recording the waveform. The backlight is illuminated in red and flashes. Besides, when the record constant on (Open) is enabled, the backlight will also be illuminated in red and flashes.

**Play/Pause:** in the stop or pause state, press this key to play back the waveform and press again to pause the play. The backlight is illuminated in yellow.

**Stop:** press this key to stop the waveform being recorded or being played back. The backlight is illuminated in orange.

## Print



Press this key to execute the print function or save the content displayed in the screen in the USB storage device in an image file. If a PictBridge printer is currently connected and the printer is in idle state, pressing this key will execute the print function. If no printer but a USB storage device is currently connected, pressing this key will save the screen content to the USB storage device in ".png" format. You can also press **Storage** to set the storage type to picture and press **Pic Type** to store the screen image in the specified picture format (bmp, png, jpeg or tiff). When a printer and a USB storage device are connected at the same time, the printer enjoys a higher priority.

## User Interface

The DS2000E provides an 8.0-inch, WVGA (800\*480) 160,000 color TFT LCD. In particular, the 14-grid ultra-wide screen enables you to view waveforms in a "longer" time span.

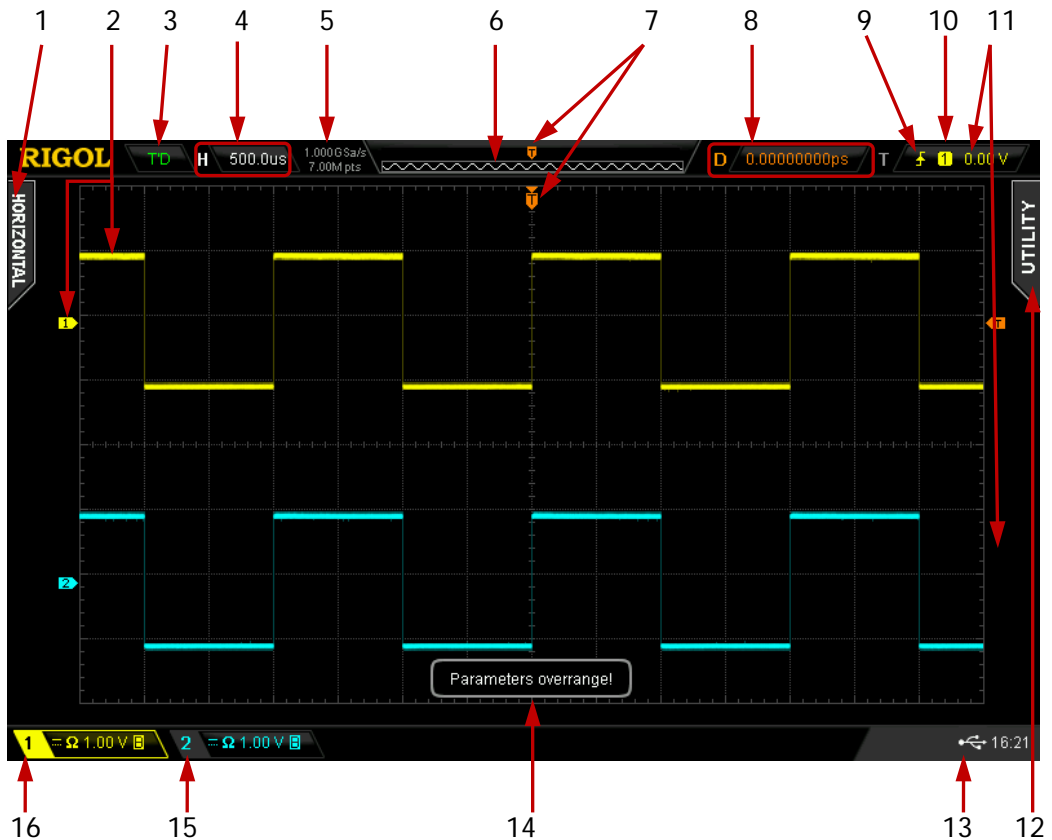

Figure 1-11 User Interface

### 1. Auto Measurement Items

Provide 16 horizontal (HORIZONTAL) parameters and 13 vertical (VERTICAL) parameters. Press the softkey at the left of the screen to enable the auto measurement function of the corresponding parameter. Press **MENU** continuously to switch between the horizontal and vertical parameters.

### 2. Channel Label/Waveform

Different channels are marked with different colors. The color of the channel

label is the same as that of the waveform.

### 3. Status

Available states include RUN, STOP, T'D (triggered), WAIT and AUTO.

### 4. Horizontal Time Base

- Represent the time per grid on the horizontal axis on the screen.
- Use **HORIZONTAL**  **SCALE** to modify this parameter. The range available is from 2.000 ns/div to 1.000 ks/div.

### 5. Sample Rate/Memory Depth

- Display the current real-time sample rate of the analog channels and memory depth of the oscilloscope.
- The parameter changes with the horizontal time base.

### 6. Waveform Memory

Provide the schematic diagram of the memory position of the waveform currently on the screen.

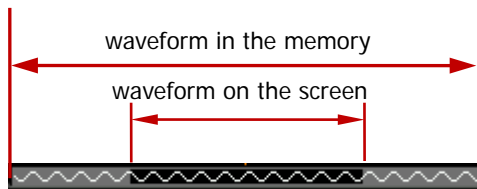

### 7. Trigger Position

Display the trigger position of the waveform in the waveform memory and on the screen.

### 8. Horizontal Position

Use **HORIZONTAL**  **POSITION** to modify this parameter. Pressing down the knob will automatically set the parameter to zero.

### 9. Trigger Type

Display the currently selected trigger type and trigger condition setting. Different labels are displayed when different trigger types are selected.

For example:  represents triggering on the rising edge in "Edge" trigger.







## 10. Trigger Source

Display the trigger source currently selected (CH1, CH2, EXT, or AC Line).

Different labels are displayed when different trigger sources are selected and the color of the trigger parameter area will change accordingly.

For example,  denotes that CH1 is selected as the trigger source.



## 11. Trigger Level

- When the trigger source is set to CH1 or CH2, the trigger level label  is displayed at the right of the screen and the trigger level value is displayed at the upper-right corner of the screen. When using **TRIGGER**  **LEVEL** to modify the trigger level, the trigger level value will change with the up and down of .
- When the trigger source is EXT, the trigger level value is displayed at the upper-right corner of the screen. No trigger level label is displayed.
- If the trigger source is AC line, no trigger level value and trigger level label are displayed.
- In Runt trigger, slope trigger and windows trigger, two trigger level labels ( and ) are displayed.



## 12. Operation Menu

Press any softkey to activate the corresponding menu. The following icons might be displayed in the menu:



Indicates that you can use the multi-function knob  to select the parameters. The backlight of  turns on when the parameter selection is valid.





Indicates that you can use the multi-function knob  to modify the parameters. The backlight of  turns on when the parameter input is valid.



Indicates that you can rotate the "**Navigation Knob**" to quickly adjust/locate parameters.



Indicates that you can rotate the multi-function knob  to adjust the parameter and then press down  to select the parameter. The backlight of  is constant on when the menu with such an icon is selected.



Indicates that the current menu has several options.



Indicates that the current menu has a submenu.



Press this key to return to the previous menu.

**Note:** The following arrow keys might appear in the grid at the lower-left corner of the operation menu:





Indicates that you can open the next page of the menu.



Indicates that you can open the previous page of the menu.

### 13. Notification Area





Display the system time, sound icon, and USB storage device icon and PictBridge printer icon.

- System Time  
Displayed in "hh:mm (hour:minute)" format. When printing or storing the waveform, the output file will contain this time message. Press **Utility** → **System** → **System Time** → **System Time** to set in the following format: yyyy-mm-dd hh:mm:ss (year-month-date hour:minute:second)
- Sound Icon  
When the sound is enabled,  will be displayed. Press **Utility** → **Sound** to enable or disable the sound.
- USB Storage Device Icon  
When a USB storage device is detected,  will be displayed.
- PictBridge Printer Icon  
When a PictBridge printer is correctly connected to the oscilloscope,  will be displayed in this area.



### 14. Message Box



Display the prompt messages.

### 15. CH2 Vertical Scale

Display the on/off status of CH2 and the voltage value per grid of CH2 waveform vertically. In addition, the following labels will be displayed according to the current channel setting: channel coupling (e.g. ) , input impedance (e.g. ) and bandwidth limit (e.g. ) . You can use **VIRTUAL**  **SCALE** to modify this parameter.

### 16. CH1 Vertical Scale

Display the on/off status of CH1 and the voltage value per grid of CH1 waveform vertically. In addition, the following labels will be displayed according to the current channel setting: channel coupling (e.g. ) , input impedance (e.g. )

and bandwidth limit (e.g. ). You can use **VERTICAL**  **SCALE** to modify this parameter.

## To Use the Security Lock

If needed, you can use the security lock (please buy it yourself) to lock the oscilloscope to a fixed location. The method is as follows, align the lock with the lock hole and plug it into the lock hole vertically; turn the key clockwise to lock the oscilloscope and then pull the key out.

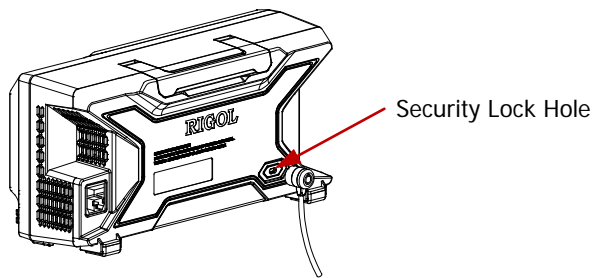

Figure 1-12 To Use the Security Lock

**Note:** Please do not insert other articles into the security lock hole to avoid damaging the instrument.

## To Use the Built-in Help System

The help system of this oscilloscope provides instructions for all the keys and menu softkeys on the front panel. Press **Help** to open the help interface and press again to close the interface. The help interface mainly consists of two parts. The left is "Help Options" and you can use "Button" or "Index" mode to select the desired help option. The right is "Help Display Area" which displays the corresponding help information.

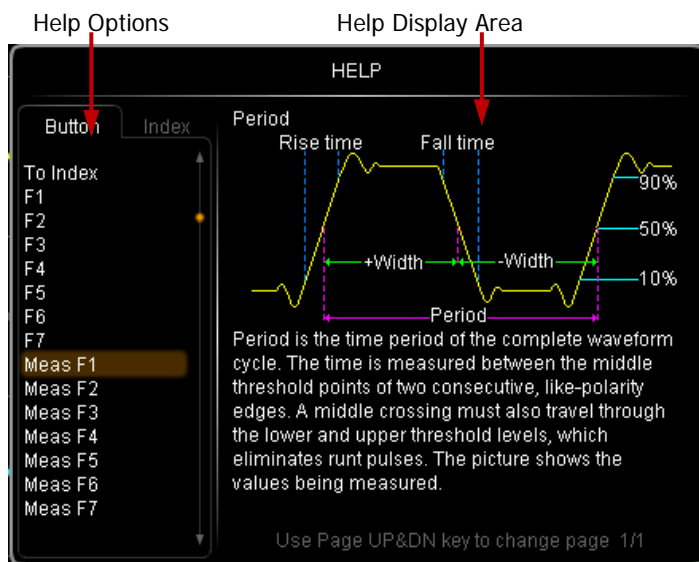









Figure 1-13 Help Interface

### Button:

Default mode. In this mode, you can press the button (except the power key  and the key  at the right of the screen) or rotate  on the front panel to select the button name (the item currently selected is displayed with brown shading) to get the corresponding help information in the "Help Display Area". Besides, you can acquire the help information of the navigation knob by directly rotating the navigation knob or using  to select "WaveSearch". Use  to select "To Index" and then press the knob to switch to **Index** mode.

### Index:

In this mode, use  to select the item that needs to get help (for example, "BW"). The item currently selected is displayed with brown shading. Press the knob to get the corresponding help information in the "Help Display Area". Use  to select "To Button" and then press the knob to switch to **Button** mode.

## Chapter 2 To Set the Vertical System

The contents of this chapter:

- To Enable the Analog Channel
- Channel Coupling
- Bandwidth Limit
- Probe Ratio
- Input Impedance
- Waveform Invert
- Vertical Scale
- Vertical Expansion
- Amplitude Unit
- Channel Label
- Delay Calibration

## To Enable the Analog Channel

DS2000E provides 2 analog input channels (CH1 and CH2) and provides independent vertical control system for each channel. As the setting methods for the vertical systems of the two channels are the same, this chapter takes CH1 as an example to illustrate the setting method for the vertical system.

Connect a signal to the input connector of CH1 and then press **CH1** in the vertical control area (VERTICAL) on the front panel to enable CH1.

At this point, the channel setting menu is displayed at the right side of the screen and the channel status label at the bottom of the screen (as shown in the figure below) is highlighted. The information displayed in the channel status label is related to the current channel setting.



After the channel is turned on, modify the parameters such as the vertical scale, horizontal time base and trigger mode according to the input signal to make the waveform display easy to be observed and measured.

## Channel Coupling

The undesired signals can be filtered out by setting the coupling mode. For example, the signal under test is a square waveform with DC offset.

- When the coupling mode is "DC": the DC and AC components can pass the channel.
- When the coupling mode is "AC": the DC components of the signal under test are blocked.
- When the coupling mode is "GND": the DC and AC components of the signal under test are both blocked.

Press **CH1** → **Coupling** and use  to select the desired coupling mode (the default is DC). The current coupling mode is displayed in the channel status label at the bottom of the screen as shown in the figures below. You can also press **Coupling** continuously to switch the coupling mode.



DC



AC



GND

## Bandwidth Limit

Setting the bandwidth limit can reduce the display noise. For example, the signal under test is a pulse with high frequency oscillation.

- When bandwidth limit is disabled, the high frequency components of the signal under test can pass the channel.
- Enable bandwidth limit and limit the bandwidth to 20 MHz or 100 MHz, the high frequency components of the signal under test that exceed 20 MHz or 100 MHz are attenuated.

**Note:** For DS2102E, the bandwidth limit is only 20 MHz.

Press **CH1** → **BW Limit** and use  to enable or disable bandwidth limit (the default is OFF). When bandwidth limit (20 MHz or 100 MHz) is enabled, the character "B" will be displayed in the channel status label at the bottom of the screen. You can also press **BW Limit** continuously to switch the bandwidth limit status.



## Probe Ratio

You can set the probe attenuation ratio manually. The probe ratio values available are as shown in the table below.

Table 2-1 Probe Attenuation Coefficient

<b>Menu</b>	<b>Attenuation Coefficient</b> (waveform display amplitude : actual waveform amplitude)
0.01X	0.01:1
0.02X	0.02:1
0.05X	0.05:1
0.1X	0.1:1
0.2X	0.2:1
0.5X	0.5:1
1X	1:1
2X	2:1
5X	5:1
10X	10:1
20X	20:1
50X	50:1
100X	100:1
200X	200:1
500X	500:1
1000X	1000:1



## Input Impedance

This oscilloscope provides two input impedance modes (1 M $\Omega$  (default) and 50  $\Omega$ ) to reduce the circuit load caused by the interaction of the oscilloscope and the circuit to be tested.

- 1M $\Omega$ : the input impedance of the oscilloscope is rather high and the current flowing into the oscilloscope from the circuit under test can be ignored.
- 50 $\Omega$ : match the oscilloscope with a device with 50  $\Omega$  output impedance.

Press **CH1** → **Input** to set the input impedance of the oscilloscope. When "50 $\Omega$ " is selected, " $\Omega$ " is displayed in the channel status label at the bottom of the screen.



**Note:** The setting of the input impedance affects the settable range of the vertical scale and vertical offset of the corresponding channel. For the details, please refer to "Specifications".

## Waveform Invert

Press **CH1** → **Invert** to turn waveform invert on or off. When waveform invert is turned off, the waveform display is normal; when waveform invert is turned on, the waveform voltage values are inverted (as shown in the figures below).

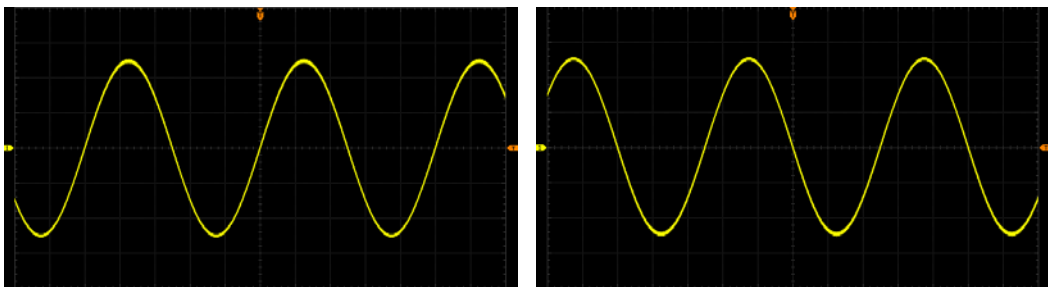

(a) "Invert" is Off

(b) "Invert" is On

Figure 2-1 Waveform Invert

## Vertical Scale

Vertical scale refers to the voltage value per grid in the vertical direction on the screen and is usually expressed as V/div.

Press **CH1** → **Volts/Div** to select the desired adjustment mode of the vertical scale, or press **VERTICAL**  **SCALE** to switch the adjustment mode quickly.

- Coarse adjustment: set the vertical scale in 1-2-5 step namely 500  $\mu$ V/div, 1 mV/div, 2 mV/div, 5 mV/div, 10 mV/div...10 V/div (take counterclockwise as an example).
- Fine adjustment: further adjust the vertical scale at a relatively smaller step to improve the vertical resolution. If the amplitude of the input waveform is a little bit greater than the full scale under the current scale and the amplitude would be a little bit lower if the next scale is used, fine adjustment can be used to improve the amplitude of waveform display to view signal details.

After the adjustment mode is selected, rotate **VERTICAL**  **SCALE** to adjust the vertical scale (clockwise to reduce the scale and counterclockwise to increase). The scale information in the channel status label (as shown in the figure below) at the bottom of the screen will change accordingly during the adjustment. The adjustable range of the vertical scale is related to the probe ratio and input impedance currently set. By default, the probe ratio is 1X, the input impedance is 1 M $\Omega$  and the adjustable range of the vertical scale is from 500  $\mu$ V/div to 10 V/div.



When adjusting the vertical scale, the waveform will be expanded or compressed around the center of the screen or the ground level of the signal according to the change of the vertical scale.

## Vertical Expansion

When using **VERTICAL**  **SCALE** to change the vertical scale of the analog channel, you can choose to expand or compress the signal vertically around the center of the screen or the ground point of the signal.

Press **Utility** → **System** → **VerticalExp** to select "Center" or "Ground" and the default is "Ground".

- Center: when the vertical scale is modified, the waveform will be expanded or compressed around the center of the screen.
- Ground: when the vertical scale is modified, the waveform will be expanded or compressed around the ground level.

## Amplitude Unit

Select the amplitude unit for the current channel. The available units are W, A, V and U. When the unit is changed, the unit displayed in the channel status label will change accordingly. Press **CH1** → **Unit** to select the desired unit and the default is V.

## Channel Label

The instrument uses the number of the channel (**1**) to mark the corresponding channel by default. For ease of use, you can also set a label for each channel, for example, **Chn1**.

**Note:** The user-defined label can include uppercase English letters (from A to Z), lowercase English letters (from a to z), numbers (from 0 to 9), underline and space; the length of the label cannot exceed 4 characters.





For example, change "**1**" to "**Chn1**". Press **CH1** → **Label** to enter the label modification interface. Press **Keyboard** to select the "Keyboard" area. Select "A" using  and press down  to switch it to "a". Select "C" using  and press down  to input the character. Use the same method to input "hn1".



Figure 2-2 Label Modification Interface

After finishing the input, press **OK** to finish the modification and the channel label will change to "Chn1".

To modify or delete the input character, press **Name** to select the "Name Input Area" and use **↶** to select the character to be modified or deleted. Enter the desired character to modify the character or press **Delete** to delete the character selected.

## Delay Calibration

When using an oscilloscope for actual measurement, the transmission delay of the probe cable may bring relatively greater error (zero offset). Zero offset is defined as the offset of the crossing point of the waveform and trigger level line relative to the trigger position, as shown in the figure below.

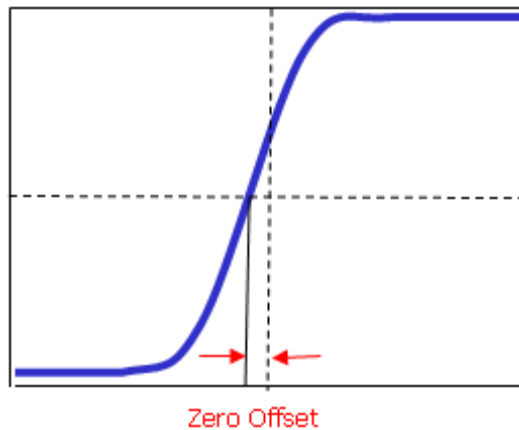



Figure 2-3 Zero Offset

For DS2000E, users can set a delay time to calibrate the zero offset of the corresponding channel. Press **CH1** → **Delay-Cal** and use  to set the desired delay time. The range available is from -200 ns to 200 ns. Pressing  down can restore the delay time to 0.00 s.

**Note:** This parameter is related to the instrument model and the current horizontal time base setting. The larger the horizontal time base is, the larger the setting step will be. Take DS2202E as an example, when the horizontal time base is 50 ns, the step is 1 ns; when the horizontal time base is 2  $\mu$ s, the step is 40 ns; when the horizontal time base is greater than or equal to 10  $\mu$ s, the delay calibration time cannot be adjusted.



## Chapter 3 To Set the Horizontal System

The contents of this chapter:

- Delayed Sweep
- Time Base Mode
- Horizontal Scale
- Horizontal Reference

# Delayed Sweep

Delayed sweep can be used to enlarge a length of waveform horizontally to view the waveform details.

Press **MENU** in the horizontal control area (HORIZONTAL) on the front panel and press **Delayed** to enable or disable delayed sweep. In delayed sweep mode, the screen is divided into two display areas as shown in the figure below.

**Note:** To enable delayed sweep, the current time base mode must be "Y-T" and the "Pass/Fail test" must be disabled.

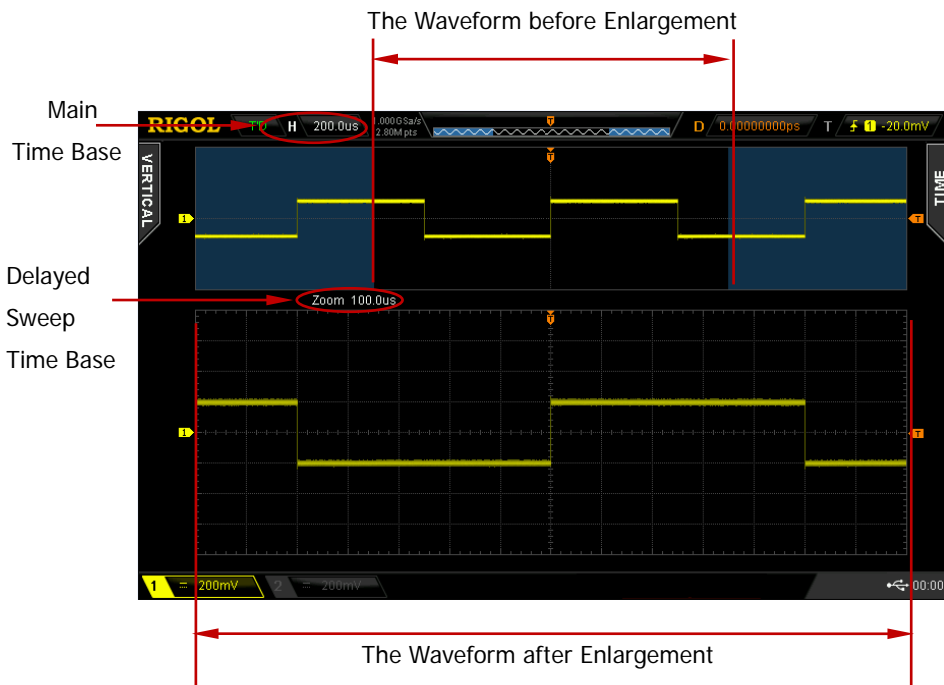

Figure 3-1 Delayed Sweep

### The Waveform before Enlargement:

The waveform in the area that has not been covered by the subtransparent blue in the upper part of the screen is the waveform before enlargement. You can turn **HORIZONTAL POSITION** to move the area left and right or turn **HORIZONTAL SCALE** to enlarge or reduce this area.



**The Waveform after Enlargement:**

The waveform in the lower part of the screen is the horizontally expanded waveform. Compared to the main time base, the delayed time base has increased the waveform resolution (as shown in the figure above).

**Note:** The delayed time base should be less than or equal to the main time base and can be modified by rotating **HORIZONTAL**  **SCALE**.

**Tip**

You can also press down **HORIZONTAL**  **SCALE** (delayed sweep shortcut key) to quickly switch to delayed sweep mode.

## Time Base Mode

Press **MENU** in the horizontal control area (HORIZONTAL) on the front panel and then press **Time Base** to select the time base mode of the oscilloscope and the default is Y-T.

### Y-T Mode

In this mode, the Y axis represents voltage and the X axis represents time.

**Note:** Only when this mode is enabled can "**Delayed Sweep**" be turned on. In this mode, when the horizontal time base is greater than or equal to 200 ms, the instrument enters slow sweep mode. For the details, please refer to the introduction of slow sweep in "**Roll Mode**".

### X-Y Mode

In this mode, the oscilloscope changes the two channels from voltage-time display mode to voltage-voltage display mode. Wherein, the X axis and Y axis tracks the voltages of CH1 and CH2 respectively. The phase deviation between two signals with the same frequency can be easily measured via Lissajous method. The figure below shows the measurement schematic diagram of the phase deviation.

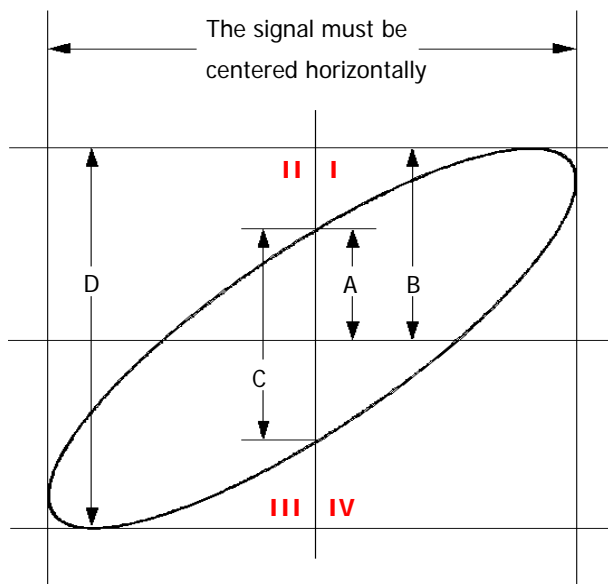

Figure 3-2 Measurement Schematic Diagram of Phase Deviation

According to  $\sin\theta=A/B$  or  $C/D$  (wherein,  $\theta$  is the phase deviation angle between the two channels and the definitions of A, B, C and D are as shown in the figure above), the phase deviation angle is obtained, that is:



$$\theta=\pm\arcsin (A/B) \text{ or } \pm\arcsin (C/D)$$

If the principal axis of the ellipse is within quadrant I and III, the phase deviation angle obtained should be within quadrant I and IV, namely within  $(0 \text{ to } \pi/2)$  or  $(3\pi/2 \text{ to } 2\pi)$ . If the principal axis of the ellipse is within quadrant II and IV, the phase deviation angle obtained should be within quadrant II and III, namely within  $(\pi/2 \text{ to } \pi)$  or  $(\pi \text{ to } 3\pi/2)$ .

X-Y function can be used to measure the phase deviation occurred when the signal under test passes through a circuit network. Connect the oscilloscope to the circuit to monitor the input and output signals of the circuit.

**Application example:** measure the phase deviation of the input signals of two channels.

### **Method 1: Use Lissajous method**

1. Connect a sine signal to CH1 and then connect a sine signal with the same frequency and amplitude but a  $90^\circ$  phase deviation to CH2.
2. Press **AUTO** and enable X-Y mode. Rotate **HORIZONTAL**  **SCALE** to adjust the sample rate properly to get better Lissajous figure for better observation and measurement.
3. Rotate **VERTICAL**  **POSITION** of CH1 and CH2 to display the signals at the center of the screen and rotate **VERTICAL**  **SCALE** of CH1 and CH2 to make the signals easy to observe. At this point, the circle as shown in the figure below should be displayed.

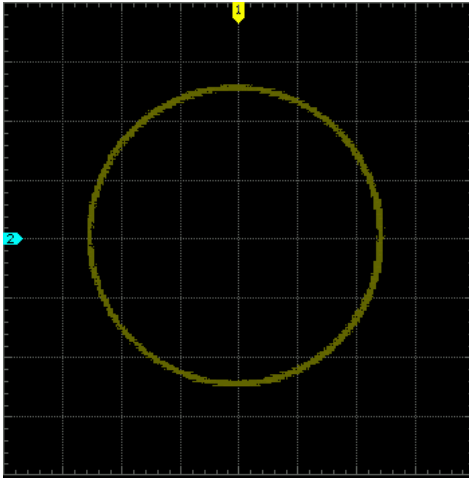

4. Observe the measurement result shown in the figure above. According to the measurement schematic diagram of the phase deviation (as shown in Figure 3-2),  $A/B (C/D) = 1$ . Thus, the phase deviation angle  $\theta = \pm \arcsin 1 = 90^\circ$ .

**Note:**

- The maximum sample rate of X-Y mode is 1.0 GSa/s. Generally, longer sample waveform can ensure better display effect of Lissajous figure. But due to the limitation of the memory depth, you have to reduce the waveform sample rate to acquire longer waveform (refer to the introduction in "**Memory Depth**"). Therefore, during the measurement, reducing the sample rate properly can acquire better display effect of Lissajous figure.
- When X-Y mode is enabled, "**Delayed Sweep**" will be disabled automatically.
- The following functions are not available in X-Y mode:  
 "Auto Measurement", "Math Operation", "Reference Waveform", "Delayed Sweep", "Vectors", "horizontal position", "To Trigger the Oscilloscope", "Protocol Decoding", "Acquisition Mode", "Pass/Fail Test", and "Waveform Record".

**Method 2: Use the shortcut measurement function**

Please measure the phase deviation between the input waveforms of CH1 and CH2 by referring to the phase deviation measurement function in "**Delay and Phase**".

## Roll Mode

In this mode, the waveform scrolls from the right to the left to update the display. The range of horizontal scale adjustment is from 200.0 ms/div to 1.000 ks/div.

**Note:** When Roll mode is enabled, the waveform "**horizontal position**", "**Delayed Sweep**", "**Protocol Decoding**", "**Pass/Fail Test**", "**Measurement Range**", "**Waveform Record**", "**To Set the Persistence Time**" and "**To Trigger the Oscilloscope**" are not available.

### Slow Sweep

Slow sweep is another mode similar to Roll mode. In Y-T mode, when the horizontal time base is set to 200 ms or slower, the instrument enters "slow sweep" mode in which the instrument first acquires the data at the left of the trigger point and then waits for trigger event. After the trigger occurs, the instrument continues to finish the waveform at the right of the trigger point. When slow sweep mode is used to observe low frequency signal, it is recommended that the "**Channel Coupling**" is set to "DC".

## Horizontal Scale

Horizontal scale, namely horizontal time base, refers to the time per grid in the horizontal direction on the screen and is usually expressed as s/div.

Being similar to "**Vertical Scale**", the horizontal scale can be adjusted in "Coarse" or "Fine" mode. Press **MENU** → **ScaleAdjust** in the horizontal control area (HORIZONTAL) on the front panel to select the desired mode.

- Coarse: set the horizontal scale in 1-2-5 step, i.g. 2 ns/div, 5 ns/div, 10 ns/div.....1.000 ks/div (taking adjusting DS2202E counterclockwise as an example).
- Fine: further adjust the horizontal scale at a relatively smaller step.

After the adjustment mode is selected, turn **HORIZONTAL**  **SCALE** to adjust the horizontal scale. Turn clockwise to reduce the horizontal scale and turn counterclockwise to increase. The scale information at the upper left corner of the screen will change accordingly during the adjustment. The range of horizontal scale adjustment is related to the model of the oscilloscope as shown in the figure below.

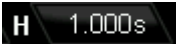

Table 3-1 Range of Horizontal Scale

Model	Horizontal Scale Range
DS2102E	5.000 ns/div to 1.000 ks/div
DS2202E	2.000 ns/div to 1.000 ks/div

When adjusting the horizontal scale, the waveform will be expanded or compressed around the center of the screen, the trigger position or the user-defined position according to the change of the horizontal scale.

## Horizontal Reference

Horizontal reference is the reference position according to which the screen waveform is expanded or compressed horizontally when adjusting **HORIZONTAL SCALE**. In Y-T mode and the delayed sweep is disabled, press **MENU** → **HorRef** in the horizontal control area (HORIZONTAL) on the front panel to select the desired reference mode and the default is "Center".

**Note:** This function is not available in X-Y mode and Roll mode as well as in Y-T mode when the delayed sweep is enabled.

### 1. Center



When changing the horizontal time base, the waveform is expanded or compressed horizontally around the center of the screen.

### 2. Trig Pos

When changing the horizontal time base, the waveform is expanded or compressed horizontally around the trigger point.

### 3. User

When changing the horizontal time base, the waveform is expanded or compressed horizontally around the user-defined reference position.

After this mode is selected, press **RefPos** and rotate  to set the user-defined reference position. The range is from -350 (the rightmost of the screen) to 350 (the leftmost of the screen) and the default is 0 (the center of the screen). Press  down to restore the reference position to 0.





# Chapter 4 To Set the Sample System

The contents of this chapter:

- Acquisition Mode
- Sample Mode
- Sample Rate
- Memory Depth
- Anti-Aliasing

## Acquisition Mode

The acquisition mode is used to control how to generate waveform points from sample points.

Press **Acquire** → **Acquisition** and use  to select the desired acquisition mode (the default is "Normal"), then press down the knob to select this mode. You can also press **Acquisition** continuously to switch the acquisition mode.

### Normal

In this mode, the oscilloscope samples the signal at equal time interval to rebuild the waveform. For most of the waveforms, the best display effect can be obtained using this mode.

### Average

In this mode, the oscilloscope averages the waveforms from multiple samples to reduce the random noise of the input signal and improve the vertical resolution. The greater the number of averages is, the lower the noise will be and the higher the vertical resolution will be but the slower the response of the displayed waveform to the waveform changes will be.

When "Average" mode is selected, press **Averages** and use  to set the desired number of averages. The numbers of averages available include 2, 4, 8, 16, 32, 64, 128, 256, 512, 1024, 2048, 4096 and 8192. The default is 2.

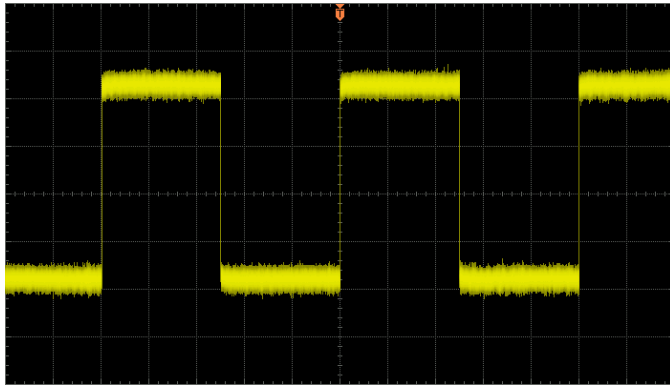

Figure 4-1 The Waveform before Average

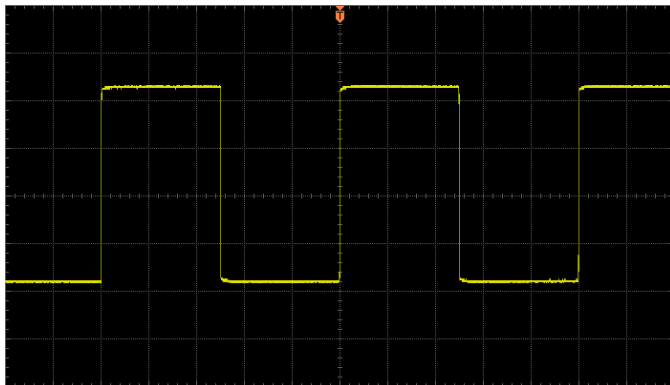

Figure 4-2 The Waveform after 256 Averages

## Peak Detect

In this mode, the oscilloscope acquires the maximum and minimum values of the signal within the sample interval to get the envelope of the signal or the narrow pulse of the signal that might be lost. In this mode, signal confusion can be prevented, but the noise displayed would be larger.

## High Resolution

This mode uses a kind of ultra-sample technique to average the neighboring points of the sample waveform to reduce the random noise on the input signal and generate much smoother waveforms on the screen. This is generally used when the sample rate of the digital converter is higher than the storage rate of the acquisition memory.

**Note:** "Average" and "High Res" modes use different averaging methods. The former uses "Multi-sample Average" and the latter uses "Single Sample Average".

## Sample Mode

This oscilloscope only supports real-time sample. In this mode, the oscilloscope samples and displays waveform within a trigger event. The maximum real-time sample rate of the analog channel of DS2000E is 1 GSa/s and the current sample rate is displayed under the **Sa Rate** menu.

**Tip**

Press **RUN/STOP** to stop the sample, the oscilloscope will hold the last display. At this point, you can still use the vertical control and horizontal control to pan and zoom the waveform.

## Sample Rate

Sample refers to the process that the oscilloscope converts analog signals to digital signals at certain time interval and stores the signals in sequence. The sample rate is the reciprocal of the time interval. The maximum real-time sample rate of the analog channel of DS2000E is 1 GSa/s.

**Note:** The sample rate is displayed in the status bar at the upper side of the screen and in the **Sa Rate** menu and can be changed indirectly by adjusting the horizontal time base through **HORIZONTAL**  **SCALE** or modifying the "Memory Depth".

The influence on the waveform when the sample rate is too low:

1. **Waveform Distortion:** when the sample rate is too low, some waveform details are lost and the waveform displayed is rather different from the actual signal.

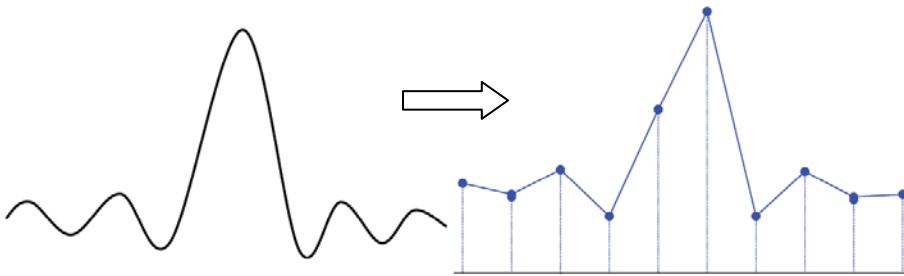

2. **Waveform Confusion:** when the sample rate is lower than twice the actual signal frequency (Nyquist Frequency), the frequency of the waveform rebuilt from the sample data is lower than the actual signal frequency.

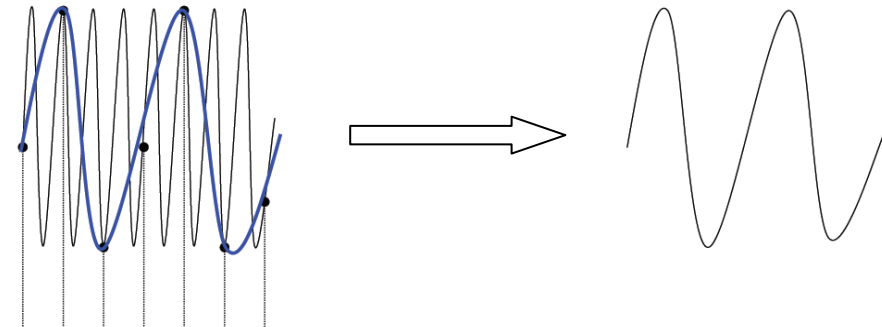

3. **Waveform Leakage:** when the sample rate is too low, the waveform rebuilt from the sample data does not reflect all the actual signal information.

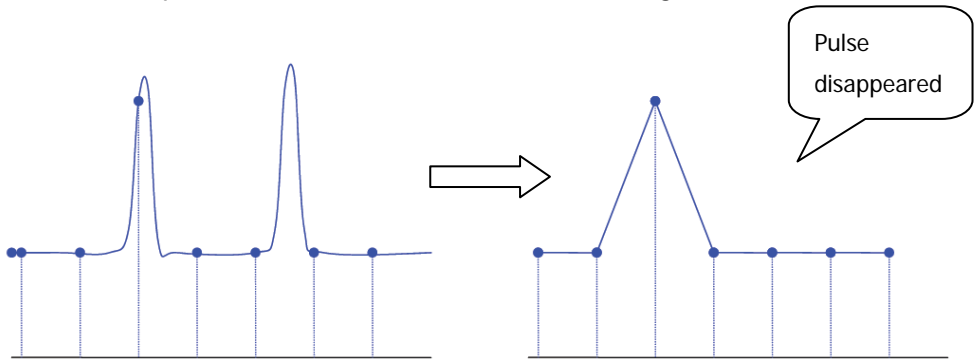

## Memory Depth

Memory depth refers to the number of waveform points that the oscilloscope can store in a single trigger sample, and it reflects the storage ability of the sample memory. DS2000E provides a maximum memory depth of 28 Mpts on both channels.

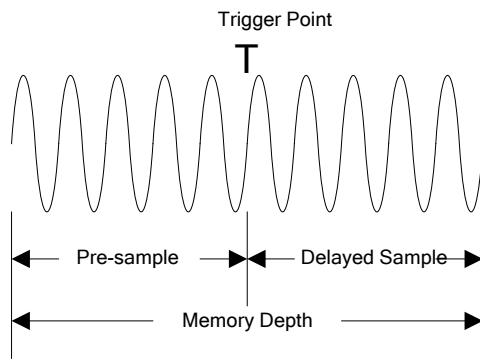



Figure 4-3 Memory Depth

The relation of memory depth, sample rate and waveform length fulfills the equation below:

$$\text{Memory depth} = \text{Sample Rate (Sa/s)} \times \text{Horizontal Time Base} \times \text{Number of Grids Horizontally}$$

Wherein, for DS2000E, the number of grids horizontally is fixed at 14. Therefore, under the same time base, higher memory depth can ensure higher sample rate.

Press **Acquire** → **Mem Depth**, use  to switch to the desired memory depth (the default is auto) and then press down the knob to select the option. You can also press **Mem Depth** continuously to switch the memory depth. The memory depth available includes Auto, 7 Kpts, 70 Kpts, 700 Kpts, 7 Mpts, and 28 Mpts.

In "Auto" mode, the oscilloscope selects the memory depth automatically according to the current sample rate. At this point, you can adjust the memory depth indirectly by rotating **HORIZONTAL**  **SCALE** to adjust the sample rate.



## Anti-Aliasing

At slower sweep speed, the sample rate is reduced and a dedicated display algorithm is used to minimize the possibility of aliasing.

Press **Acquire** → **Anti-Aliasing** to enable or disable the anti-aliasing function. By default, anti-aliasing is disabled.



## Chapter 5 To Trigger the Oscilloscope

As for trigger, you set certain trigger condition according to the requirement and when a waveform in the waveform stream meets this condition, the oscilloscope captures this waveform as well as the neighbouring part and displays them on the screen. For digital oscilloscope, it displays waveform continuously no matter whether it is stably triggered, but only stable trigger can ensures stable display. The trigger module guarantees that each time base sweep or sample starts when the input signal meets the trigger condition defined by users; namely each sweep and sample are synchronous and the waveforms acquired overlap to display a stable waveform.

Trigger setting should be based on the features of the input signal, thus you need to have some knowledge of the signal under test to quickly capture the desired waveform. This oscilloscope provides abundant advanced trigger types which can help you to focus on the desired waveform details.

The contents of this chapter:

- Trigger Source
- Trigger Mode
- Trigger Coupling
- Trigger Holdoff
- Noise Rejection
- Trigger Type
- Trigger Output Connector

## Trigger Source

Press **MENU** → **Source** in the trigger control area (TRIGGER) on the front panel to select the desired trigger source. Signals input from CH1, CH2, or the **[EXT TRIG]** connector, as well as the AC line can all be used as the trigger source.

### Analog channel input:

Signals input from analog channels CH1 and CH2 can all be used as the trigger source. No matter whether the channel selected is enabled, the channel can work normally.

### External trigger input:

Signals (such as external clock and signal of the circuit to be tested) input from the **[EXT TRIG]** connector can be used as the trigger source. When this type of trigger source is selected, you can set the trigger level within -4 V to +4 V by rotating **TRIGGER**  **LEVEL**.

When 2 analog channels are used for data acquisition, the trigger signal input from the **[EXT TRIG]** connector can be used as the trigger source.

### AC line:

The trigger signal is obtained from the AC power input of the oscilloscope. AC trigger is usually used to measure signals relevant to the AC power frequency. For example, stably trigger the waveform output from the transformer of a transformer substation; it is mainly used in related measurements of the power industry.

## Trigger Mode

The following is the schematic diagram of the acquisition memory. To easily understand the trigger event, the acquisition memory is divided into the pre-trigger buffer and post-trigger buffer.

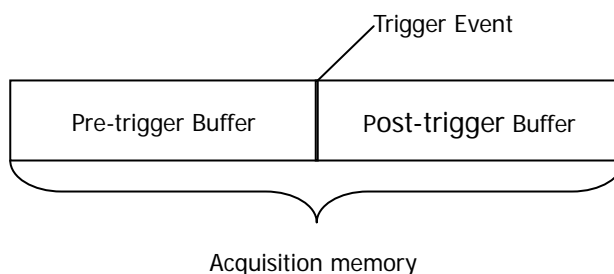

Figure 5-1 Schematic Diagram of the Acquisition Memory

After the system runs, the oscilloscope operates by first filling the pre-trigger buffer. It starts searching for a trigger after the pre-trigger buffer is filled. While searching for the trigger, the data sampled will still be transmitted to the pre-trigger buffer (the new data will continuously overwrite the previous data). When a trigger is found, the pre-trigger buffer contains the data acquired just before the trigger. Then, the oscilloscope will fill the post-trigger buffer and display the data in the acquisition memory. If the acquisition is activated via **RUN/STOP**, the oscilloscope will repeat this process; if the acquisition is activated via **SINGLE**, the oscilloscope will stop after finishing a single acquisition (you can pan and zoom the waveform currently displayed).

Press **MODE** in the trigger control area (TRIGGER) on the front panel or press **MENU** → **Sweep** to select the desired trigger mode. The corresponding status light of the mode currently selected turns on.

### Auto:

In this trigger mode, the oscilloscope will trigger and sample to display the waveforms forcibly if no specified trigger condition is found.

This trigger mode is applicable to the following conditions: the signal level is unknown; the DC should be displayed; the trigger condition always occurs; forcible trigger is not required.

**Normal:**

In this trigger mode, the oscilloscope triggers and samples data only when the specified trigger condition is found.

This trigger mode should be used when the signal is with low repetition rate or only the event specified by the trigger setting needs to be sampled as well as when auto trigger should be prevented to acquire stable display.

**Single:**

In this trigger mode, the oscilloscope performs a single trigger and acquisition when the specified trigger condition is found and then stops.

This trigger mode should be used when you need to perform a single acquisition of the specified event and analyze the acquisition result (you can pan and zoom the waveform currently displayed and the subsequent waveform data will not overwrite the current waveform).

**Note:** In Normal and Single trigger modes, pressing **FORCE** can force a trigger.

## Trigger Coupling

Trigger coupling decides which kind of components will be transmitted to the trigger module. Please distinguish it with "**Channel Coupling**".

- DC: allow DC and AC components into the trigger path.
- AC: block all the DC components and attenuate signals lower than 75 Hz.
- LF Reject: block the DC components and reject the low frequency components (lower than 75 kHz).
- HF Reject: reject the high frequency components (higher than 75 kHz).

Press **MENU** → **Setting** → **Coupling** in the trigger control area (TRIGGER) on the front panel to select the desired coupling type (the default is DC).

**Note:** Trigger coupling is only valid in edge trigger and when the trigger source is CH1 or CH2.

## Trigger Holdoff

Trigger holdoff can be used to stably trigger the complex waveforms. Holdoff time is the amount of time that the oscilloscope waits after a trigger before re-arming the trigger module. The oscilloscope will not trigger even if the trigger condition is met during the holdoff time and will only re-arm the trigger module after the holdoff time expires. For example, to stably trigger the repeat pulse series as shown in the figure below, the holdoff time should be set to a value greater than T1 and lower than T2.

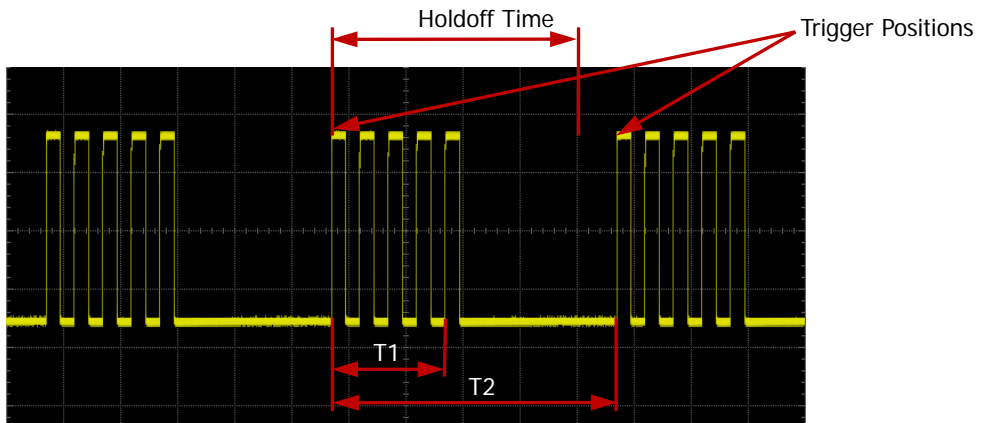



Figure 5-2 Schematic Diagram of Trigger Holdoff

Press **MENU** (in the trigger control area (TRIGGER) on the front panel) → **Setting** → **Holdoff**; then, turn  or the inner knob of the navigation knob to modify the holdoff time at a relatively smaller step or turn the outer knob of the navigation knob to adjust the holdoff time (the default is 100 ns) at a relatively larger step until the trigger becomes stable. The adjustable range is from 100 ns to 10 s.

**Note:** For DS2000E, the trigger types that support trigger holdoff include edge trigger, pulse trigger, runt trigger, windows trigger, slope trigger, pattern trigger, delay trigger, and duration trigger.

## Noise Rejection

Noise rejection can reject the high frequency noise in the signal and reduce the possibility of miss-trigger of the oscilloscope.

Press **MENU** → **Setting** → **Noise Reject** in the trigger control area (TRIGGER) on the front panel to enable or disable noise rejection.



## Trigger Type



DS2000E provides various trigger types, including various serial bus triggers. You can press **MENU** (in the trigger control area (TRIGGER) on the front panel) → **Type** to select the desired trigger type.

- Edge Trigger
- Pulse Trigger
- Runt Trigger
- Windows Trigger (Option)
- Nth Edge Trigger (Option)
- Slope Trigger
- Video Trigger (HDTV Option)
- Pattern Trigger
- Delay Trigger (Option)
- TimeOut Trigger (Option)
- Duration Trigger (Option)
- Setup/Hold Trigger
- RS232 Trigger
- I2C Trigger
- SPI Trigger
- USB Trigger (Option)
- CAN Trigger (Option)

## Edge Trigger

Trigger on the trigger threshold of the specified edge of the input signal.

### Trigger Type:

Press **Type**, rotate  to select "Edge" and press down . At this point, the trigger setting information is displayed at the upper right corner of the screen. For example,

. The trigger type is edge trigger; the trigger source is CH1; the trigger level is 170 mV.



### Source Selection:

Press **Source** to select CH1, CH2, EXT, or AC Line. For the details, please refer to the introduction in "**Trigger Source**". The current trigger source is displayed at the upper right corner of the screen.

**Note:** Select channel with signal input as trigger source to obtain stable trigger.

### Edge Type:

Press **Slope** to select the kind of edge of the input signal on which the oscilloscope triggers. The current edge type is displayed at the upper right corner of the screen.

- : trigger on the rising edge of the input signal when the voltage level meets the preset trigger level.
- : trigger on the falling edge of the input signal when the voltage level meets the preset trigger level.
- : trigger on the rising or falling edge of the input signal when the voltage level meets the preset trigger level.

### Trigger Mode:



Press **Sweep** and select "Auto", "Normal" or "Single". For the details, please refer to "**Trigger Mode**". The corresponding status light of the current trigger mode turns on.

### Trigger Setting:

Press **Setting** to set the trigger parameters (trigger coupling, trigger holdoff and noise rejection) under this trigger type.

**Note:** Trigger coupling is only available when the trigger source is CH1 or CH2. When the trigger source is AC Line, **Noise Reject** is grayed out and disabled.



**Trigger Level:**

Trigger occurs only when the signal reaches the preset trigger level. When you rotate the **TRIGGER**  **LEVEL** knob to modify the level, an orange trigger level line and a trigger mark "" appear on the screen, and they move up or down with the rotation of the knob. Meanwhile, the trigger level value (e.g. ) at the lower-left corner of the screen also changes accordingly. When stopping turning the knob, the trigger level line and the trigger mark disappear in about 2 s.

## Pulse Trigger

In pulse trigger mode, the oscilloscope will trigger when the pulse width of the input signal satisfies the specified pulse width condition.

### Trigger Type:

Press **Type**, rotate  to select "Pulse" and press down . At this point, the trigger setting information is displayed at the upper right corner of the screen. For example,



The trigger type is pulse trigger; the trigger source is CH1; the trigger level is 0.00 V.

### Source Selection:

Press **Source** to select CH1, CH2, or EXT. For the details, please refer to the introduction in "**Trigger Source**". The current trigger source is displayed at the upper-right corner of the screen.

**Note:** Select channel with signal input as trigger source to obtain stable trigger.

### Pulse Condition:

In this oscilloscope, positive pulse width is defined as the time difference between the two crossing points of the trigger level and positive pulse; negative pulse width is defined as the time difference between the two crossing points of the trigger level and negative pulse, as shown in the figure below.

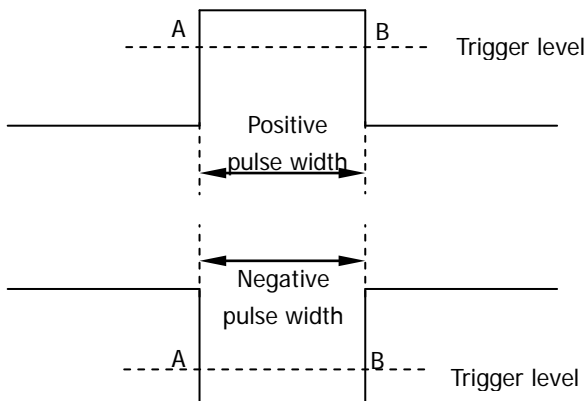















Figure 5-3 Positive Pulse Width/Negative Pulse Width

Press **When** to select the desired pulse condition.

- : trigger when the positive pulse width of the input signal is greater than

- the specified pulse width.
- : trigger when the positive pulse width of the input signal is lower than the specified pulse width.
  - : trigger when the positive pulse width of the input signal is greater than the specified lower limit of pulse width and lower than the upper limit of pulse width.
  - : trigger when the negative pulse width of the input signal is greater than the specified pulse width.
  - : trigger when the negative pulse width of the input signal is lower than the specified pulse width.
  - : trigger when the negative pulse width of the input signal is greater than the specified lower limit of pulse width and lower than the upper limit of pulse width.

### Pulse Width Setting:

- When the **Pulse Condition** is set to , ,  or , press **Setting** and turn  or the inner knob of the navigation knob to adjust the pulse width at a relatively smaller step or turn the outer knob of the navigation knob to adjust the pulse width at a relatively larger step. The range available is from 2 ns to 4 s.
- When the **Pulse Condition** is set to  or , press **Upper Limit** and **Lower Limit** respectively and adjust the upper limit and lower limit of pulse width using  or the navigation knob by referring to the method mentioned above. The range of the upper limit is from 10 ns to 4 s. The range of the lower limit is from 2 ns to 3.99 s.

**Note:** The lower limit of the pulse width must be lower than the upper limit.

### Trigger Mode:

Press **Sweep** and select "Auto", "Normal" or "Single". For the details, please refer to "**Trigger Mode**". The corresponding status light of the current trigger mode turns on.

### Trigger Setting:

Press **Setting** to set the trigger parameters (trigger holdoff and noise rejection) under this trigger type.

### Trigger Level:

Use **TRIGGER**  **LEVEL** to modify the level. For the details, please refer to the introduction of "**Trigger Level**".

## Runt Trigger

Runt trigger is used to trigger pulses that pass one trigger level but fail to pass the other one.

For this oscilloscope, positive runt pulses are defined as pulses that pass the lower limit of the trigger level but fail to pass the upper limit of the trigger level; negative runt pulses are defined as pulses that pass the upper limit of the trigger level but fail to pass the lower limit of the trigger level, as shown in the figure below.

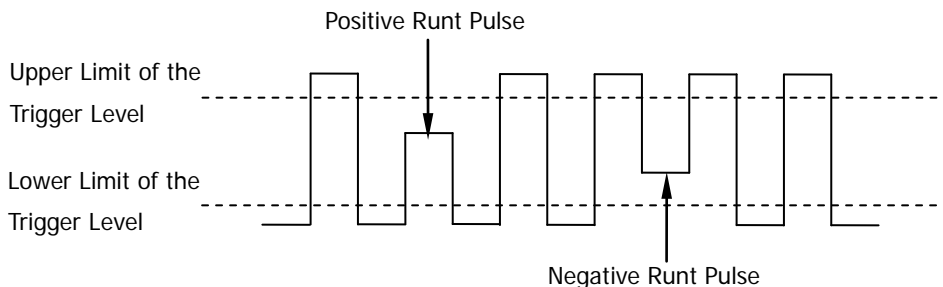



Figure 5-4 Runt Trigger

### Trigger Type:

Press **Type**, rotate  to select "Runt" and press down . At this point, the trigger setting information is displayed at the upper right corner of the screen. For example,



The trigger type is runt trigger; the trigger source is CH1; the difference between the upper limit of trigger level and the lower limit of trigger level is 3.06 V.



### Source Selection:

Press **Source** to switch the signal source list between CH1 and CH2. For the details, please refer to the introduction in "**Trigger Source**". The current trigger source is displayed at the upper right corner of the screen.

**Note:** Select channel with signal input as trigger source to obtain stable trigger.





### Pulse Polarity:

Press **Polarity** to select the pulse polarity of runt trigger.

- : positive polarity. The instrument triggers on the positive runt pulse.
- : negative polarity. The instrument triggers on the negative runt pulse.

**Qualifier:**

Press **Qualifier** to set the trigger conditions of runt trigger.



- **None**: do not set the trigger condition of runt trigger.
- **>**: trigger when the runt pulse width is greater than the lower limit of pulse width. Press **Lower Limit** and turn  or the inner knob of the navigation knob to adjust the minimum runt pulse width at a relatively smaller step or turn the outer knob of the navigation knob to adjust the minimum runt pulse width at a relatively larger step. The range available is from 2 ns to 4 s.
- **<**: trigger when the runt pulse width is lower than the upper limit of pulse width. Press **Upper Limit** and turn  or the inner knob of the navigation knob to adjust the maximum runt pulse width at a relatively smaller step or turn the outer knob of the navigation knob to adjust the maximum runt pulse width at a relatively larger step. The range available is from 2 ns to 4 s.
- **<>**: trigger when the runt pulse width is greater than the lower limit and lower than the upper limit of pulse width. Press **Upper Limit** and set the maximum pulse width of runt trigger using  or the navigation knob by referring to the method mentioned above; the range is from 10 ns to 4 s. Press **Lower Limit** and set the minimum pulse width of runt trigger using  or the navigation knob by referring to the method mentioned above; the range is from 2 ns to 3.99 s.

**Note:** The lower limit of the pulse width must be lower than the upper limit.

**Vertical Window and Trigger Level:**

After the trigger condition setting is completed, you need to adjust the trigger level to correctly trigger the signal and obtain stable waveform. The adjustment mode of the trigger level is different when different vertical window is selected in the runt trigger. Press **Vertical** and use  to select the desired vertical window or press down **Vertical** continuously to switch the vertical window. You can choose to only adjust the upper limit, the lower limit or both of them.

**Note:** Under the "Runt trigger" menu, you can press **TRIGGER**  **LEVEL** continuously to switch among different vertical window.



After the vertical window type is selected, you can rotate **TRIGGER**  **LEVEL** to adjust the trigger level. During the adjustment, two orange trigger level lines and trigger marks ( and ) appear on the screen and move up or down with the rotation of the knob. At the same time, the current trigger level values are displayed at the lower left corner of the screen; wherein, Up Level denotes the trigger level

upper limit and Low Level denotes the trigger level lower limit. The trigger level lines and trigger marks disappear after you stop rotating the knob for about 2 s.



Up Level: 2.43 V  
Low Level: -3.00 V

The adjustment mode of the trigger level differs when different vertical window is selected.

- : only adjust the upper limit of the trigger level. During the adjustment, the "Up Level" changes accordingly and "Low Level" remains unchanged.
- : only adjust the lower limit of the trigger level. During the adjustment, the "Low Level" changes accordingly and the "Up Level" remains unchanged.
- : adjust the upper and lower limits of the trigger level at the same time. During the adjustment, the "Up Level" and "Low Level" change accordingly.

#### Trigger Mode:

Press **Sweep** and select "Auto", "Normal" or "Single". For the details, please refer to "Trigger Mode". The corresponding status light of the current trigger mode turns on.

#### Trigger Setting:



Press **Setting** to set the trigger parameters (trigger holdoff and noise rejection) under this trigger type.



## Windows Trigger (Option)

Windows trigger provides a high trigger level and a low trigger level. The oscilloscope triggers when the rising edge of the input signal passes through the high trigger level or when the falling edge of the input signal passes through the low trigger level.

### Trigger Type:

Press **Type**, rotate  to select "Windows" and press down . At this point, the trigger setting information is displayed at the upper right corner of the screen. For

example, . The trigger type is windows trigger; the trigger source is CH1; the difference between the high trigger level and the low trigger level is 1.24 V.



### Source Selection:

Press **Source** to switch the signal source list between CH1 and CH2. For the details, please refer to the introduction in "**Trigger Source**". The current trigger source is displayed at the upper right corner of the screen.

**Note:** Select channel with signal input as trigger source to obtain stable trigger.

### Windows Type:

Press **WndType** to select the kind of edge of the input signal on which the oscilloscope triggers.

- : trigger on the rising edge of the input signal when the voltage level is greater than the preset high trigger level.
- : trigger on the falling edge of the input signal when the voltage level is lower than the preset low trigger level.
- : trigger on any edge of the input signal when the voltage level meets the preset trigger level.

### Trigger Position:

After selecting the windows type, press **Position** to further specify the time point of trigger by selecting the trigger position.

- **Enter:** trigger when the input signal enters the specified trigger level range.
- **Exit:** trigger when the input signal exits the specified trigger level range.
- **Time:** used to specify the hold time of the input signal after entering the specified trigger level range. The instrument triggers when the accumulated hold time is greater than the windows time. The range is from 16 ns to 4 s and

the default is 1.00  $\mu$ s.

### Vertical Window and Trigger Level:

Press **Vertical** to select the desired vertical window type. Rotate **TRIGGER**  **LEVEL** to adjust the trigger level. For the detailed operation, please refer to "**Vertical Window and Trigger Level**".

### Trigger Mode:

Press **Sweep** and select "Auto", "Normal" or "Single". For the details, please refer to "**Trigger Mode**". The corresponding status light of the current trigger mode turns on.

### Trigger Setting:

Press **Setting** to set the trigger parameters (trigger holdoff and noise rejection) under this trigger type.

## Nth Edge Trigger (Option)

Trigger on the nth edge that appears after the specified idle time. For example, in the waveform shown in the figure below, the instrument should trigger on the second rising edge after the specified idle time (the time between two neighbouring rising edges) and the idle time should be set to  $P < \text{Idle Time} < M$ . Wherein,  $M$  is the time between the first rising edge and its previous rising edge and  $P$  is the maximum time between the rising edges participate in the counting.

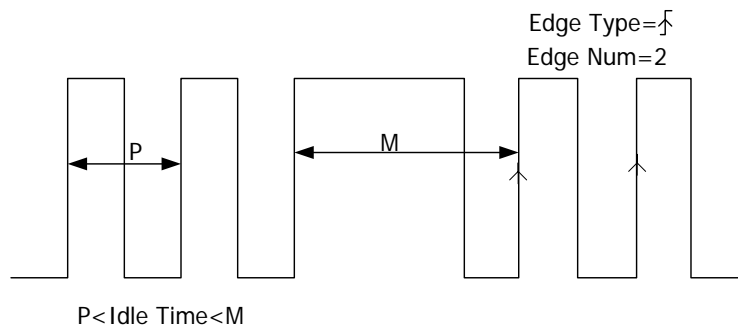





Figure 5-5 Nth Edge Trigger

### Trigger Type:

Press **Type**, rotate  to select "Nth Edge" and press down . At this point, the trigger setting information is displayed at the upper right corner of the screen. For example, . The trigger type is Nth edge trigger; the trigger source is CH1; the trigger level is 1.94 V.

### Source Selection:

Press **Source** to select CH1 or CH2. For the details, please refer to the introduction in "**Trigger Source**". The current trigger source is displayed at the upper right corner of the screen.

**Note:** Select channel with signal input as trigger source to obtain stable trigger.

### Edge Type:

Press **Slope** to select the kind of edge of the input signal on which the oscilloscope triggers.

- : trigger on the rising edge of the input signal when the voltage level meets the specified trigger level.

- : trigger on the falling edge of the input signal when the voltage level meets the specified trigger level.

**Idle Time:**

Press **Idle** to set the idle time before the edge counting in Nth edge trigger. Use  or the inner knob of the navigation knob to adjust the idle time at a relatively smaller step or turn the outer knob of the navigation knob to adjust the idle time at a relatively larger step. The range available is from 16 ns to 4 s.

**Edge Number:**

Press **Edge** to set the value of "N" in Nth edge trigger. Use  or the inner knob of the navigation knob to adjust the number of edges at a relatively smaller step or turn the outer knob of the navigation knob to adjust the number of edges at a relatively larger step. The range available is from 1 to 65535.

**Trigger Mode:**

Press **Sweep** and select "Auto", "Normal" or "Single". For the details, please refer to "**Trigger Mode**". The corresponding status light of the current trigger mode turns on.

**Trigger Setting:**

Press **Setting** to set the trigger parameters (noise rejection) under this trigger type.



**Trigger Level:**

Use **TRIGGER**  **LEVEL** to modify the level. For the details, please refer to the introduction of "**Trigger Level**".

## Slope Trigger

In slope trigger, the oscilloscope triggers on the positive slope or negative slope with the specified time.

### Trigger Type:

Press **Type**, rotate  to select "Slope" and press down . At this point, the trigger setting information is displayed at the upper right corner of the screen. For

example, . The trigger type is slope trigger; the trigger source is CH1; the difference between the upper limit of trigger level and the lower limit of trigger level is 1.24 V.

### Source Selection:

Press **Source** to switch the signal source list between CH1 and CH2. For the details, please refer to the introduction in "**Trigger Source**". The current trigger source is displayed at the upper right corner of the screen.

**Note:** Select channel with signal input as trigger source to obtain stable trigger.

### Slope Condition:

In this oscilloscope, positive slope time is defined as the time difference between the two crossing points of trigger level line A and B with the rising edge; negative slope time is defined as the time difference between the two crossing points of trigger level line A and B with the falling edge as shown in the figure below.

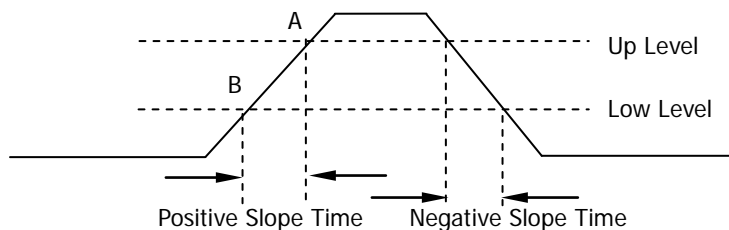















Figure 5-6 Positive Slope Time/Negative Slope Time

Press **When** to select the desired slope condition.

- : trigger when the positive slope time of the input signal is greater than the specified time.
- : trigger when the positive slope time of the input signal is lower than the specified time.
- : trigger when the positive slope time of the input signal is greater than



- the specified lower limit of time and lower than the specified upper limit of time.
- : trigger when the negative slope time of the input signal is greater than the specified time.
- : trigger when the negative slope time of the input signal is lower than the specified time.
- : trigger when the negative slope time of the input signal is greater than the specified lower limit of time and lower than the specified upper limit of time.



### Time Setting:





- When the **Slope Condition** is set to , ,  or , press **Time** and turn  or the inner knob of the navigation knob to adjust the time value at a relatively smaller step or turn the outer knob of the navigation knob to adjust the time value at a relatively larger step. The range available is from 10 ns to 1 s.
- When the **Slope Condition** is set to  or , press **Upper Limit** and **Lower Limit** respectively; adjust the time upper limit and lower limit using  or the navigation knob by referring to the method mentioned above. The range of time upper limit is from 20 ns to 1 s. The range of the time lower limit is from 10 ns to 999 ms.

**Note:** The time lower limit must be lower than the upper limit.



### Vertical Window and Trigger Level:

After the trigger condition setting is completed, adjust the trigger level using **TRIGGER**  **LEVEL** to correctly trigger the signal and obtain stable waveform. The adjustment mode of the trigger level is different when different vertical window is selected in slope trigger. Press **Vertical** and use  to select the desired vertical window or press down **Vertical** continuously to switch the vertical window. You can choose to only adjust the upper limit, the lower limit or both of them.

- : only adjust the upper limit of the trigger level. During the adjustment, "UP Level" and "Slew Rate" change accordingly but "Low Level" remains unchanged.
- : only adjust the lower limit of the trigger level. During the adjustment, "Low Level" and "Slew Rate" change accordingly but "UP Level" remains unchanged.
- : adjust the upper and lower limits of the trigger level at the same time. During the adjustment, "UP Level" and "Low Level" change accordingly but "Slew Rate" remains unchanged.

When the **Slope Condition** is set to , , , or , the current trigger level and slew rate will be displayed at the lower left corner of the screen, as shown in Figure 5-7 (a). The formula of slew rate is:

$$SlewRate = \frac{UpLevel - LowLevel}{Time}$$

When the **Slope Condition** is set to  or , the current trigger level and slew rate range will be displayed at the lower left corner of the screen, as shown in Figure 5-7 (b). The formula of slew rate range is:

$$SlewRate = \frac{UpLevel - LowLevel}{UpperLimit} \sim \frac{UpLevel - LowLevel}{LowerLimit}$$

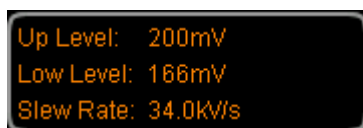



(a)



(b)

Figure 5-7 Trigger Level Information

**Note:** Under the "Slope" trigger menu, you can also press down the trigger level knob continuously to switch the vertical window.

During the adjustment, two orange trigger level lines and two trigger marks ( and ) appear on the screen and move up and down with the rotation of the knob, when stopping turning the knob, the trigger level lines and trigger marks disappear in about 2 s.

#### Trigger Mode:

Press **Sweep** and select "Auto", "Normal" or "Single". For the details, please refer to "**Trigger Mode**". The corresponding status light of the current trigger mode turns on.



#### Trigger Setting:

Press **Setting** to set the trigger parameters (trigger holdoff and noise rejection) under this trigger type.

## Video Trigger (HDTV Option)

The video signal can include image information and timing information and can adopt various standards and formats. DS2000E can trigger on the standard video signal field or line of NTSC (National Television Standards Committee), PAL (Phase Alternating Line), SECAM (Sequential Couleur A Memoire) or HDTV (High Definition Television).

### Trigger Type:

Press **Type**, rotate  to select "Video" and press down . At this point, the trigger setting information is displayed at the upper right corner of the screen. For



example, . The trigger type is video trigger; the trigger source is CH1; the trigger level is 76.0 mV.

### Source Selection:

Press **Source** to switch the trigger source between CH1 and CH2. For the details, please refer to the introduction in "**Trigger Source**". The current trigger source is displayed at the upper right corner of the screen.

**Note:** Select channel with signal input as trigger source to obtain stable trigger.

### Video Polarity:

Press **Polarity** to select the desired video polarity. The polarities available are positive polarity () and negative polarity (.

### Sync:

Press **Sync** to select the desired sync type.

- All Lines: trigger on the first line found.
- Line Num: trigger on the specified line.

When this sync trigger mode is selected, you can modify the line number. Press **Line Num** and turn  or the inner knob of the navigation knob to adjust the line number at a relatively smaller step or turn the outer knob of the navigation knob to adjust the line number at a relatively larger step.

The range of the line number is from 1 to 525 (NTSC), 1 to 625 (PAL/SECAM), 1 to 525 (480P), 1 to 625 (576P), 1 to 750 (720P), 1 to 1125 (1080P) or 1 to 1125 (1080I).

- Odd Field: trigger on the rising edge of the first ramp pulse in the odd field.
- Even Field: trigger on the rising edge of the first ramp pulse in the even field.



**Video Standard:**

Press **Standard** to select the desired video standard.

- NTSC: the field frequency is 60 fields per second and the frame frequency is 30 frames per second. The TV scan line is 525 with the even field goes first and the odd field follows behind.
- PAL/SECAM:
  - PAL: the frame frequency is 25 frames per second. The TV scan line is 625 with the odd field goes first and the even field follows behind.
  - SECAM: the frame frequency is 25 frames per second. The TV scan line is 625 with interlaced scan.
- 480P: the frame frequency is 60 frames per second; the TV scan line is 525; progressive scan; the line frequency is 31.5 kHz.
- 576P: the frame frequency is 60 frames per second; the TV scan line is 625; progressive scan.
- HDTV: The specified video standards are as follows.
  - 720P: the frame frequency is 60 frames per second. The TV scan line is 750. Progressive scan. The line frequency is 45 KHz. The field frequencies available are 60 Hz, 50 Hz, 30 Hz, 25 Hz and 24 Hz.
  - 1080P: the frame frequency is 60 frames per second. The TV scan line is 1125. Progressive scan. Professional format. The field frequencies available are 60 Hz, 50 Hz, 30 Hz, 25 Hz and 24 Hz.
  - 1080I: the frame frequency is 25 to 30 frames per second. The TV scan line is 1125. Interlaced scan. The line frequency is 33.75 KHz. The field frequencies available are 30 Hz, 25 Hz and 24 Hz.

**Trigger Mode:**

Press **Sweep** and select "Auto", "Normal" or "Single". For the details, please refer to "**Trigger Mode**". The corresponding status light of the current trigger mode turns on.

**Trigger Setting:**

Press **Setting** to set the trigger parameters (noise rejection) under this trigger type.

**Trigger Level:**

Use **TRIGGER**  **LEVEL** to modify the level. For the details, please refer to the introduction of "**Trigger Level**".

**Tips**

- For a better observation of the waveform details in the video signal, you can set a larger memory depth first.
- In the trigger debugging process of video signals, the frequency in different part of the signal can be reflected by different brightness as **RIGOL** digital oscilloscopes provides the multi-level gray scale display function. Experienced users can quickly judge the signal quality and discover abnormalities.

## Pattern Trigger

This trigger mode identifies a trigger condition by looking for a specified pattern. The pattern is a logical "AND" combination of the channels. Each channel can have a value of high (H), low (L) or don't care (X). A rising or falling edge can be specified for one channel included in the pattern. When an edge is specified, the oscilloscope will trigger at the edge specified if the pattern set for the other channels are true (namely the actual pattern of the channel is the same with the preset pattern). If no edge is specified, the oscilloscope will trigger on the last edge that makes the pattern true. If all the channels in the pattern are set to "Don't Care", the oscilloscope will not trigger.

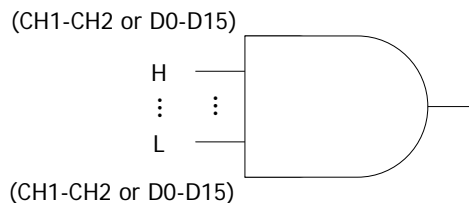





Figure 5-8 Pattern Trigger

### Trigger Type:

Press **Type**, rotate  to select "Pattern" and press down . At this point, the trigger setting information is displayed at the upper right corner of the screen. For example, . The trigger type is pattern trigger; the trigger source is CH1; the trigger level is 1.84 V.





### Source Selection:

Press **Source** to open the signal source list and select CH1 or CH2. For the details, please refer to the introduction in "**Trigger Source**". The current trigger source is displayed at the upper right corner of the screen.

### Pattern Setting:

Press **Code** to set the pattern of the current source. At this point, the pattern setting area (as shown in the figure below) is displayed at the bottom of the screen.



- : set the pattern of the channel selected to "H", namely the voltage level is higher than the trigger level of the channel.
- : set the pattern of the channel selected to "L", namely the voltage level is lower than the trigger level of the channel.
- : set the pattern of the channel selected to "Don't Care", namely this channel is not used as a part of the pattern. When both the channels in the pattern are set to "Don't Care", the oscilloscope will not trigger.
-  or : set the pattern of the channel selected to the rising or falling edge.

**Note:** Only one rising or falling edge can be specified in the pattern. If one edge item is currently defined and then another edge item is defined in another channel in the pattern, the former edge item defined will be replaced by X.

#### Trigger Mode:

Press **Sweep** and select "Auto", "Normal" or "Single". For the details, please refer to "**Trigger Mode**". The corresponding status light of the current trigger mode turns on.

#### Trigger Setting:

Press **Setting** to set the trigger parameters (trigger holdoff and noise rejection) under this trigger type.

#### Trigger Level:

The trigger level of each channel needs to be set independently. For example, set the trigger level of CH1. Press **Source** and select CH1; use **TRIGGER**  **LEVEL** to modify the level. For the details, please refer to the introduction of "**Trigger Level**".

## Delay Trigger (Option)

In delay trigger, you need to set signal source A and signal source B. The oscilloscope triggers when the time difference ( $\Delta T$ ) between the specified edges of source A (Edge A) and source B (Edge B) meets the preset time limit, as shown in the figure below.

**Note:** Edge A and Edge B must be neighbouring edges.

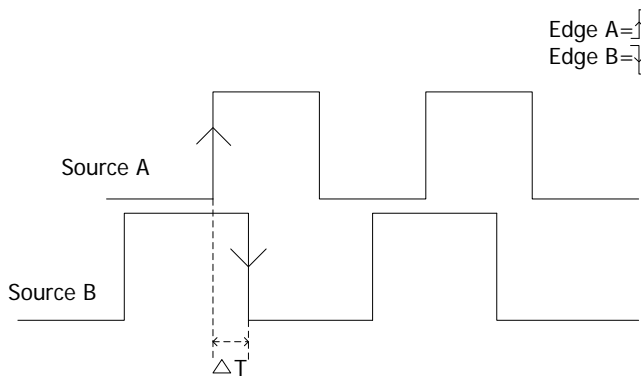





Figure 5-9 Delay Trigger

### Trigger Type:

Press **Type** to open the trigger type list. Rotate  and press down  to select "Delay". At this point, the trigger setting information is displayed at the upper right



corner of the screen. For example, . The trigger type is delay trigger; the trigger source is CH1; the trigger level is -1.80 V.

### Source A:

Press **SourceA** to select CH1 or CH2 as the trigger source of signal source A. For the details, please refer to the introduction in "**Trigger Source**". The signal source currently selected is displayed in the upper-right corner of the screen.

**Note:** Select channel with signal input as trigger source to obtain stable trigger.

### Edge A:



Press **EdgeA** to select the trigger edge type of signal source A in delay trigger. It can be set to the rising edge () or falling edge (.

**Source B:**

Press **SourceB** to select CH1 or CH2 as the trigger source of signal source B. For the details, please refer to the introduction in "**Trigger Source**". The signal source currently selected is displayed in the upper-right corner of the screen.





**Note:** Select channel with signal input as trigger source to obtain stable trigger.

**Edge B:**



Press **EdgeB** to select the trigger edge type of signal source B in delay trigger. It can be set to the rising edge () or falling edge (.

**Delay Type:**

Press **DelayType** to set the time limit condition of delay trigger.

- **>**: trigger when the time difference ( $\Delta T$ ) between the specified edges of source A and source B is greater than the preset time limit. Press **Time** and use  or the inner knob of the navigation knob to adjust the delay time of delay trigger at a relatively smaller step or use the outer knob of the navigation knob to adjust the delay time of delay trigger at a relatively larger step. The settable range is from 2 ns to 4 s.
- **<**: trigger when the time difference ( $\Delta T$ ) between the specified edges of source A and source B is lower than the preset time limit. Press **Time** and adjust the delay time of delay trigger using  or the navigation knob by referring to the method mentioned above. The settable range is from 2 ns to 4 s.
- **<>**: trigger when the time difference ( $\Delta T$ ) between the specified edges of source A and source B is greater than the lower limit of the preset time and lower than the upper limit of the preset time. Press **Upper Limit** and adjust the delay time upper limit of delay trigger using  or the navigation knob by referring to the method mentioned above; the settable range is from 12 ns to 4 s. Press **Lower Limit** and adjust the delay time lower limit of delay trigger using  or the navigation knob by referring to the method mentioned above; the settable range is from 2 ns to 3.99 s.

**Note:** The time lower limit must be lower than the time upper limit.

- **><**: trigger when the time difference ( $\Delta T$ ) between the specified edges of source A and source B is lower than the lower limit of the preset time or greater than the upper limit of the preset time. Press **Upper Limit** and adjust the delay time upper limit of delay trigger using  or the navigation knob by referring to the method mentioned above; the settable range is from 12 ns to 4 s. Press **Lower Limit** and adjust the delay time lower limit of delay trigger using  or

the navigation knob by referring to the method mentioned above; the settable range is from 2 ns to 3.99 s.

**Note:** The time lower limit must be lower than the time upper limit.



### Trigger Mode:

Press **Sweep** to open the trigger mode list and select "Auto", "Normal" or "Single". For the details, please refer to "**Trigger Mode**". The corresponding status light of the current trigger mode turns on.

### Trigger Setting:

Press **Setting** to set the trigger parameters (trigger holdoff and noise rejection) under this trigger type.

### Trigger Level:

Press **SourceA** and use **TRIGGER**  **LEVEL** to modify the trigger level of source A.  
Press **SourceB** and use **TRIGGER**  **LEVEL** to modify the trigger level of source B.  
For the details, please refer to the introduction of "**Trigger Level**".

## TimeOut Trigger (Option)

In timeout trigger, the instrument triggers when the time interval ( $\Delta T$ ) from when the rising edge (or falling edge) of the input signal passes through the trigger level to when the neighbouring falling edge (or rising edge) passes through the trigger level is greater than the timeout time set, as shown in the figure below.

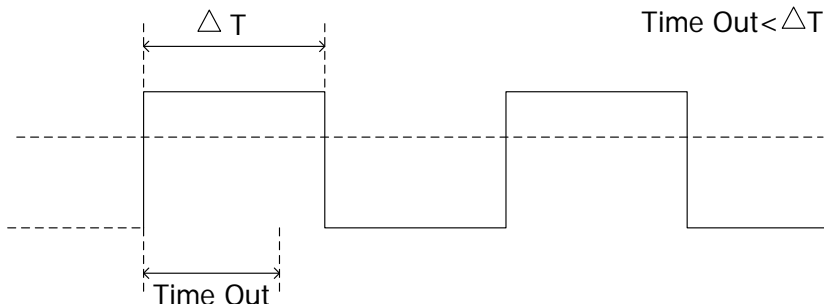





Figure 5-10 TimeOut Trigger

### Trigger Type:

Press **Type** to open the trigger type list. Rotate  and press down  to select "TimeOut". At this point, the trigger setting information is displayed at the upper

right corner of the screen. For example, . The trigger type is timeout trigger; the trigger source is CH1; the trigger level is -1.80 V.



### Source Selection:

Press **Source** to open the signal source list and select CH1 or CH2. For the details, please refer to the introduction in "**Trigger Source**". The current trigger source is displayed at the upper right corner of the screen.

**Note:** Select channel with signal input as trigger source to obtain stable trigger.

### Edge Type:

Press **Slope** to select the type of the first edge of the input signal that passes through the trigger level.

- : start timing when the rising edge of the input signal passes through the trigger level.
- : start timing when the falling edge of the input signal passes through the trigger level.
- : start timing when any edge of the input signal passes through the trigger level.

### Timeout Time:



The timeout time refers to the longest period of time that the signal remains unchanged after it passes through the trigger level. Press **TimeOut** and use  or the inner knob of the navigation knob to adjust the timeout time at a relatively smaller step or use the outer knob of the navigation knob to adjust the timeout time at a relatively larger step. The range is from 16 ns to 4 s.

**Trigger Mode:**

Press **Sweep** to open the trigger mode list and select "Auto", "Normal" or "Single". For the details, please refer to "**Trigger Mode**". The corresponding status light of the current trigger mode turns on.

**Trigger Setting:**

Press **Setting** to set the trigger parameter (noise rejection) under this trigger type.

**Trigger Level:**

Use **TRIGGER**  **LEVEL** to modify the level. For the details, please refer to the introduction of "**Trigger Level**".

## Duration Trigger (Option)

In duration trigger, the instrument identifies a trigger condition by looking for the duration of a specified pattern. This pattern is a logical "AND" combination of the two channels. Each channel can have a value of high (H), low (L) or don't care (X). The instrument triggers when the duration ( $\Delta T$ ) of this pattern meets the preset time, as shown in the figure below.

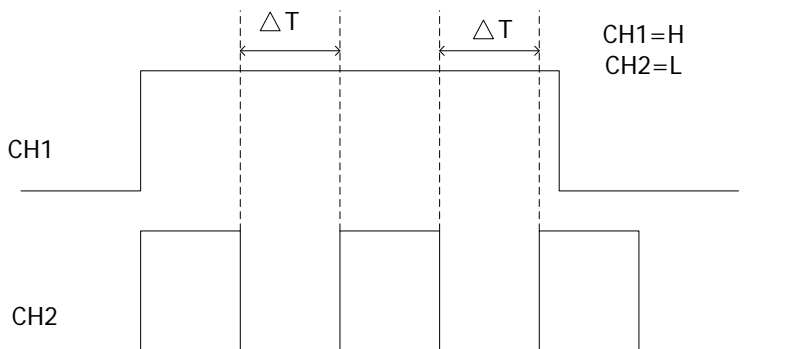





Figure 5-11 Duration Trigger

### Trigger Type:

Press **Type** to open the trigger type list. Rotate  and press down  to select "Duration". At this point, the trigger setting information is displayed at the upper

right corner of the screen. For example, . The trigger type is duration trigger; the trigger source is CH1; the trigger level is 0.00 V.

### Source Selection:

Press **Source** to open the signal source list and select CH1 or CH2. For the details, please refer to the introduction in "**Trigger Source**". The current trigger source is displayed at the upper right corner of the screen.

### Pattern Setting:

Press **Code** to set the pattern of the current channel. At this point, the pattern setting area (as shown in the figure below) is displayed at the bottom of the screen.







- **H**: set the pattern of the channel selected to "H", namely the voltage level is higher than the trigger level of the channel.
- **L**: set the pattern of the channel selected to "L", namely the voltage level is lower than the trigger level of the channel.

- **X**: set the pattern of the channel selected to "Don't Care", namely this channel is not used as a part of the pattern. When both the channels in the pattern are set to "Don't Care", the oscilloscope will not trigger.

### Trigger Condition:

Press **When** to select the desired trigger condition.

- **>**: trigger when the duration of the pattern is greater than the preset time. Press **Time** and use  or the inner knob of the navigation knob to adjust the duration of duration trigger at a relatively smaller step or use the outer knob of the navigation knob to adjust the duration of duration trigger at a relatively larger step. The range is from 2 ns to 4 s.
- **<**: trigger when the duration of the pattern is lower than the preset time. Press **Time** and adjust the duration of duration trigger using  or the navigation knob by referring to the method mentioned above. The range is from 2 ns to 4 s.
- **<>**: trigger when the duration of the pattern is lower than the upper limit of the preset time and greater than the lower limit of the preset time. Press **Upper Limit** and adjust the duration upper limit of duration trigger using  or the navigation knob by referring to the method mentioned above; the range is from 12 ns to 4 s. Press **Lower Limit** and adjust the duration lower limit of duration trigger using  or the navigation knob by referring to the method mentioned above; the range is from 2 ns to 3.99 s.

**Note:** The time lower limit must be lower than the time upper limit.

### Trigger Mode:

Press **Sweep** to open the trigger mode list and select "Auto", "Normal" or "Single". For the details, please refer to "**Trigger Mode**". The corresponding status light of the current trigger mode turns on.

### Trigger Setting:

Press **Setting** to set the trigger parameters (trigger holdoff and noise rejection) under this trigger type.

### Trigger Level:

Press **Source** to open the signal source list and select CH1 or CH2. Rotate the **TRIGGER**  **LEVEL** knob to modify the level. For the details, please refer to the introduction of "**Trigger Level**".

## Setup/Hold Trigger

In setup/hold trigger, you need to set the data signal line and clock signal line. The setup time starts when the data signal passes the trigger level/threshold level and ends at the coming of the specified clock edge; the hold time starts at the coming of the specified clock edge and ends when the data signal passes the trigger level/threshold level again (as shown in the figure below). During the setup or hold, the data signal must remain a valid pattern. The oscilloscope triggers when the setup time or hold time is lower than the preset time.

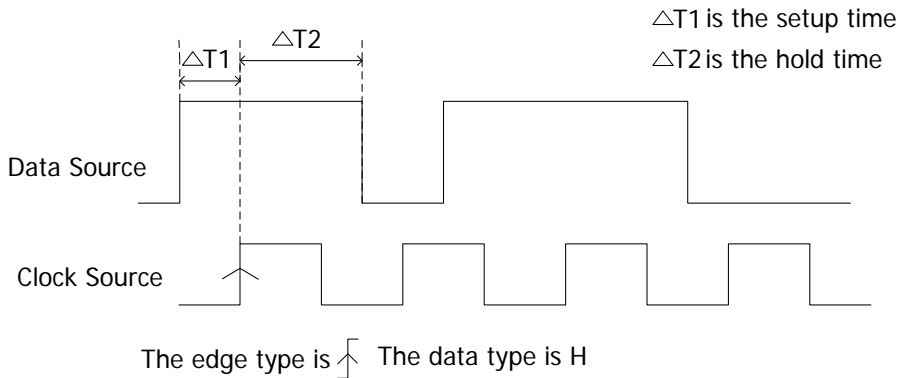

Figure 5-12 Setup/Hold Trigger

**Trigger Type:**

Press **Type** to open the trigger type list. Rotate and press down to select "Setup/Hold". At this point, the trigger setting information is displayed at the upper

right corner of the screen. For example, . The trigger type is setup/hold trigger; the trigger source is CH1; the trigger level is -1.80 V.

**Source Selection:**

Press **DataSrc** and **ClkSrc** to set the signal sources of the data line and clock line respectively. They can be set to CH1 or CH2. For the details, please refer to the introduction in "Trigger Source". The current trigger source is displayed at the upper right corner of the screen.

**Note:** Select channel with signal input as trigger source to obtain stable trigger.

**Edge Type:**



Press **Slope** to select the desired clock edge type and it can be set to the rising edge () or falling edge () .

**Data Type:**

Press **Pattern** to set the effective pattern of the data signal to H (high level) or L (low level).

**Setup Type:**

Press **SetupType** to select the desired setup type.

- **Setup**: the oscilloscope will trigger only according to the setup time. Press **Setup**; use  or the inner knob of the navigation knob to adjust the setup time at a relatively smaller step or turn the outer knob of the navigation knob to adjust the setup time at a relatively larger step. The adjustable range is from 2 ns to 1 s.
- **Hold**: the oscilloscope will trigger only according to the hold time. Press **Hold** and adjust the hold time using  or the navigation knob by referring to the method mentioned above. The adjustable range is from 2 ns to 1 s.
- **SetupHold**: the oscilloscope will trigger according to both the setup time and hold time. Press **Setup** and **Hold** respectively; adjust the setup time and hold time using  or the navigation knob by referring to the method mentioned above. Both the adjustable ranges are from 2 ns to 1 s.



**Trigger Mode:**

Press **Sweep** to open the trigger mode list and select "Auto", "Normal" or "Single". For the details, please refer to "**Trigger Mode**". The corresponding status light of the current trigger mode turns on.

**Trigger Setting:**

Press **Setting** to set the trigger parameters (noise rejection) under this trigger type.

**Trigger Level:**

Press **DataSrc** and use **TRIGGER**  **LEVEL** to modify the trigger level of the data source channel. Press **ClkSrc** and use **TRIGGER**  **LEVEL** to modify the trigger level of the clock source channel. For the details, please refer to the introduction of "**Trigger Level**".

## RS232 Trigger

RS232 bus is a serial communication mode used in the data transmission between PCs or between PC and terminal. In RS232 serial protocol, a character is transmitted as a frame of data which consists of 1 bit start bit, 5~8 bits data bits, 1 bit check bit

and 1~2 bits stop bit(s). Its format is as shown in the figure below.

DS2000E oscilloscope triggers when the start frame, error frame, check error, or the specified data of the RS232 signal is detected.

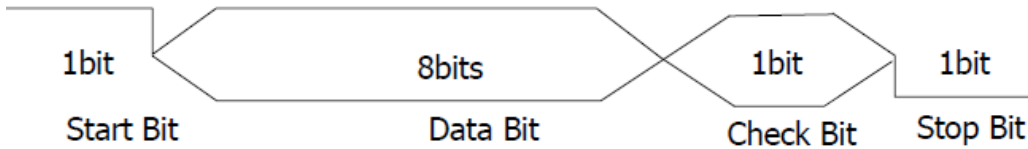





Figure 5-13 RS232 protocol diagram

### Trigger Type:

Press **Type** to open the trigger type list. Rotate  and press down  to select "RS232". At this point, the trigger setting information is displayed at the upper right corner of the screen. For example, . The trigger type is RS232 trigger; the trigger source is CH1; the trigger level is -1.80 V.

### Source Selection:

Press **Source** to open the signal source list and select CH1 or CH2. For the details, please refer to the introduction in "**Trigger Source**". The current trigger source is displayed at the upper right corner of the screen.

**Note:** Select channel with signal input as trigger source to obtain stable trigger.

### Polarity:

Press **Polarity** to select the polarity of data transmission. It can be set to "Normal" or "Invert" and the default is "Normal".

### Trigger Condition:

Press **When** to select the desired trigger condition.

- Start: trigger on the start frame position.
- Error: trigger when error frame is detected. After this trigger condition is selected:
  - press **Stop Bit** to select "1 bit" or "2 bit";
  - press **Even-Odd** to select "None", "Odd" or "Even".
 The oscilloscope will determine error frame according to the preset parameters.
- Check Error: trigger when check error is detected. When this trigger condition is selected:
  - press **Stop Bit** to select "1 bit" or "2 bit".

--press **Even-Odd** to select "Odd" or "Even".

The oscilloscope will determine check error according to the current settings.

- Data: trigger on the last bit of the preset data bits. When this trigger condition is selected:

--press **Data Bits** to select "5 bit", "6 bit", "7 bit" or "8 bit";

--press **Data** and input the data value according to the setting in **Data Bits** and the ranges are from 0 to 31, from 0 to 63, from 0 to 127 and from 0 to 255 respectively.

--press **Stop Bit** to select "1 bit" or "2 bit".

--press **Even-Odd** to select "None", "Odd" or "Even".

### Baud Rate:

Set the baud rate of data transmission (equal to specifying a clock frequency). Press **Baud** to set the desired baud rate to 2400 bps, 4800 bps, 9600 bps (default), 19200 bps, 38400 bps, 57600 bps, 115200 bps, 230400 bps, 460800 bps, 921600 bps, 1 Mbps or User. When "User" is selected, press **Setup** and use  or the inner knob of the navigation knob to adjust the baud rate at a relatively smaller step or turn the outer knob of the navigation knob to adjust the baud rate at a relatively larger step. The adjustable range is from 110 bps to 20 Mbps.

### Trigger Mode:

Press **Sweep** to open the trigger mode list and select "Auto", "Normal" or "Single". For the details, please refer to "**Trigger Mode**". The corresponding status light of the current trigger mode turns on.

### Trigger Setting:

Press **Setting** to set the trigger parameter (noise rejection) under this trigger type.

### Trigger Level:

Use **TRIGGER**  **LEVEL** to modify the level. For the details, please refer to the introduction of "**Trigger Level**".

## I2C Trigger

I2C is a 2-wire serial bus used to connect the microcontroller and its peripheral device and is a bus standard widely used in the microelectronic communication control field.

The I2C serial bus consists of SCL and SDA. Its transmission rate is determined by

SCL and its transmission data is determined by SDA, as shown in the figure below. DS2000E triggers on start condition, restart condition, stop condition, missing acknowledgement, specific device address or data value. Besides, it can also trigger on the specific device address and data value at the same time.

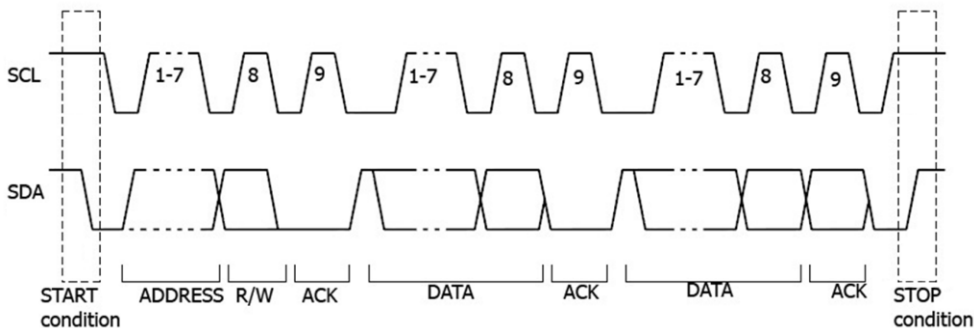



Figure 5-14 I2C protocol diagram

**Trigger Type:**

Press **Type** to open the trigger type list. Rotate  and press down  to select "I2C". At this point, the trigger setting information is displayed at the upper right

corner of the screen. For example, . The trigger type is I2C trigger; the trigger source is CH1; the trigger level is 0.00 V.

**Source Selection:**

Press **SCL** and **SDA** to specify the signal sources of SCL and SDA respectively. They can be set to CH1 or CH2. For the details, please refer to the introduction in "**Trigger Source**". The current trigger source is displayed at the upper right corner of the screen.

**Note:** Select channel with signal input as trigger source to obtain stable trigger.

**Trigger Condition:**

Press **When** to select the desired trigger condition.

- Start: trigger when SDA data transitions from high to low while SCL is high.
- Restart: trigger when another start condition occurs before a stop condition.
- Stop: trigger when SDA data transitions from low to high while SCL is high.
- Missing ACK: trigger when the SDA data is high during any acknowledgement of SCL clock position.
- Address: trigger on the read or write bit when the preset address is met. After



this trigger condition is selected:

--press **AddrBits** to select "7 bit", "8 bit" or "10 bit";

--press **Address** to set the address value by rotating the multi-function knob  according to the setting in **AddrBits** and the ranges are from 0 to 127, from 0 to 255 and from 0 to 1023 respectively;

--press **Direction** to select "Read", "Write" or "R/W". **Note:** This setting is not available when **AddrBits** is set to "8 bit".

- Data: find the preset data value on SDA, and trigger on the dump edge of the SCL of the last bit of the data. After this trigger condition is selected:
  - press **Byte Length** to set the length of the data and the range is from 1 to 5;
  - press **CurrentBit** to select the desired data bit and the range is from 0 to (Byte Length×8-1);
  - press **Data** to set the data pattern of the current data bit to X, H or L.
  - press **AllBits** to set the data pattern of all the data bits to the data pattern specified in **Data**.
- A&D: find the set address and data at the same time and trigger when the "Address" and "Data" conditions are both met. After this trigger condition is selected:
  - press **AddrBits** to select "7 bit", "8 bit" or "10 bit";
  - press **Address** to set the address value by rotating the multi-function knob  according to the setting in **AddrBits** and the ranges are from 0 to 127, from 0 to 255 and from 0 to 1023 respectively;
  - press **Byte Length** to set the length of the data and the range is from 1 to 5;
  - press **CurrentBit** to select the desired data bit and the range is from 0 to (Byte Length×8-1);
  - press **Data** to set the data pattern of the current data bit to X, H or L.
  - press **AllBits** to set the data pattern of all the data bits to the data pattern specified in **Data**.
  - press **Direction** to select "Read", "Write" or "R/W". **Note:** This setting is not available when **AddrBits** is set to "8 bit".



### Trigger Mode:

Press **Sweep** to open the trigger mode list and select "Auto", "Normal" or "Single". For the details, please refer to "**Trigger Mode**". The corresponding status light of the current trigger mode turns on.

### Trigger Setting:

Press **Setting** to set the trigger parameters (noise rejection) under this trigger type.

#### Trigger Level:

Press **SCL** and use **TRIGGER**  **LEVEL** to modify the trigger level of the SCL channel. Press **SDA** and use **TRIGGER**  **LEVEL** to modify the trigger level of the SDA channel. For the details, please refer to the introduction of "**Trigger Level**".

## SPI Trigger

Trigger on the data pattern on the specified edge. When using SPI trigger, you need to specify the SCL and SDA data sources. Below is the SPI bus data transmission diagram.

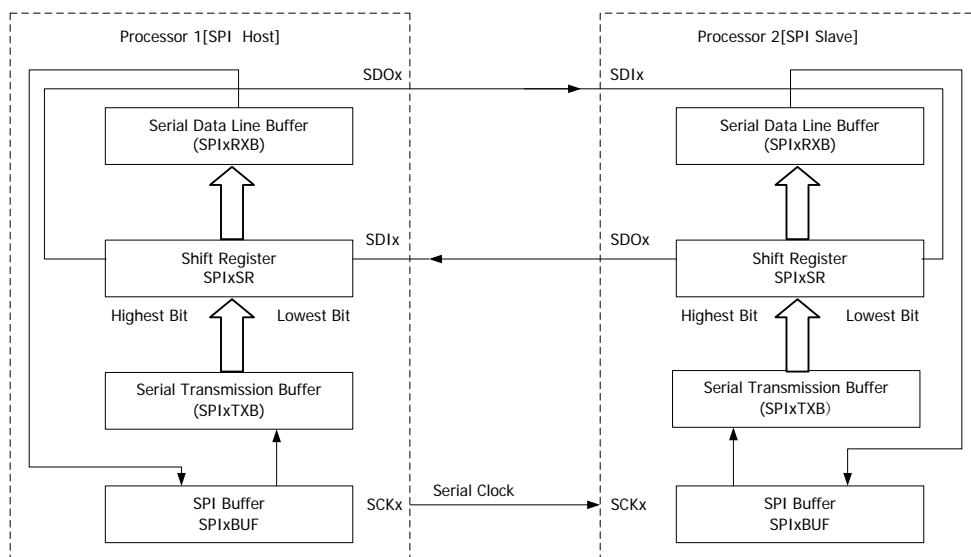





Figure 5-15 SPI bus data transmission diagram

### Trigger Type:

Press **Type** to open the trigger type list. Rotate  and press down  to select "SPI". At this point, the trigger setting information is displayed at the upper right corner of the screen. For example, . The trigger type is SPI trigger; the trigger source is CH1; the trigger level is 0.00 V.

### Source Selection:

Press **SCL** and **SDA** to specify the data sources of SCL and SDA respectively. They can be set to CH1 or CH2. For the details, please refer to the introduction in "**Trigger Source**". The current trigger source is displayed at the upper right corner of the screen.

**Note:** Select channel with signal input as trigger source to obtain stable trigger.

**TimeOut:**

Set the minimum time during which the clock signal (SCL) remains idle before the oscilloscope begins to search for the data (SDA) to be triggered on the oscilloscope. Press **TimeOut**, and use  or the inner knob of the navigation knob to adjust the minimum time of the idle status at a relatively smaller step; or rotate the outer knob of the navigation knob to adjust the timeout period at a relatively larger step. The adjustable range is from 100 ns to 1 s.

**Trigger Condition:**

The trigger condition of the oscilloscope is "TimeOut" by default, and no other alternatives are available.



**Data Line Setting:**

Press **Data** to set the data bits and data for SPI trigger.

- Press **Data Bits** to set the number of bits of the serial data character string. It can be set to any integer between 4 and 32.
- Press **CurrentBit** to set the number of the data bit and the range is from 0 to (value specified in **Data Bits** – 1).
- Press **Data** to set the value of the current bit to H, L or X.
- Press **AllBits** to set all the data bits to the value specified in **Data**.

**Clock Edge:**

Press **Clock Edge** to select the desired clock edge.

- : sample the SDA data on the rising edge of the clock signal.
- : sample the SDA data on the falling edge of the clock signal.



**Trigger Mode:**

Press **Sweep** to open the trigger mode list and select "Auto", "Normal" or "Single". For the details, please refer to "**Trigger Mode**". The corresponding status light of the current trigger mode turns on.

**Trigger Setting:**

Press **Setting** to set the trigger parameters (noise rejection) under this trigger type.

**Trigger Level:**

Press **SCL** and use **TRIGGER**  **LEVEL** to modify the trigger level of the SCL channel. Press **SDA** and use **TRIGGER**  **LEVEL** to modify the trigger level of the SDA channel. For the details, please refer to the introduction of "**Trigger Level**".

## USB Trigger (Option)

Trigger on the SOP, EOP, RC, Suspend and Exit Suspend of the data packet on the differential USB data cable (D+ and D-). This trigger supports USB Low Speed and Full Speed. Below is the USB data transmission protocol diagram.

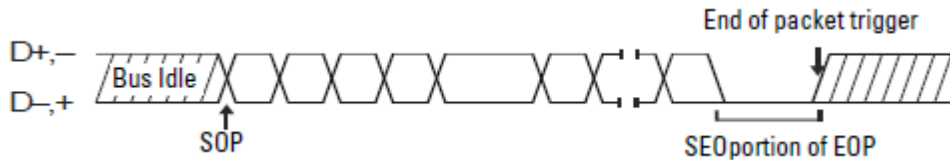





Figure 5-16 USB data transmission protocol diagram

### Trigger Type:

Press **Type** to open the trigger type list. Rotate  and press down  to select "USB". At this point, the trigger setting information is displayed at the upper right

corner of the screen. For example, . The trigger type is USB trigger; the trigger source is CH1; the trigger level is 0.00 V.

### Source Selection:

Press **D+** and **D-** to specify data sources for D+ and D- data cables respectively. They can be set to CH1 or CH2. For the details, please refer to the introduction in "**Trigger Source**". The current trigger source is displayed at the upper right corner of the screen.

**Note:** Select channel with signal input as trigger source to obtain stable trigger.

### Signal Speed:

Press **Speed** to select "Low Speed" (1.5 Mb/s) or "Full Speed" (12 Mb/s).

### Trigger Condition:

Press **When** to select the desired trigger condition.

- **SOP:** trigger at the sync bit at the start of the data packet (SOP).
- **EOP:** trigger at the end of the SEO portion of the EOP of the data packet.
- **RC:** trigger when SEO is greater than 10 ms.
- **Suspend:** trigger when the idle state of the bus is greater than 3 ms.

- **ExitSuspend**: trigger when the bus exits from idle state for more than 10 ms.



**Trigger Mode:**

Press **Sweep** to open the trigger mode list and select "Auto", "Normal" or "Single". For the details, please refer to "**Trigger Mode**". The corresponding status light of the current trigger mode turns on.

**Trigger Setting:**

Press **Setting** to set the trigger parameters (noise rejection) under this trigger type.

**Trigger Level:**

Press **D+** and use **TRIGGER**  **LEVEL** to modify the trigger level of the D+ channel. Press **D-** and use **TRIGGER**  **LEVEL** to modify the trigger level of the D- channel. For the details, please refer to the introduction of "**Trigger Level**".

## CAN Trigger (Option)

Trigger on the start frame, end frame, specified frame type or error frame of the CAN signal. When using CAN trigger, you need to specify the signal source, signal rate and trigger signal type of the CAN signal. The figure below shows the standard and expanded formats of CAN bus data frame.

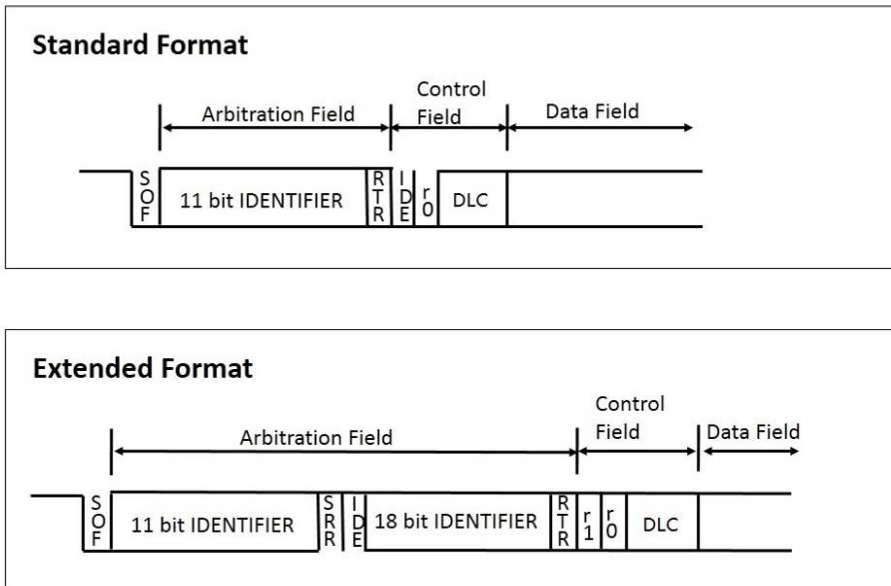

Figure 5-17 Standard and Expanded Formats of CAN Bus Data Frame

### Trigger Type:

Press **Type**; rotate and press down to select "CAN". At this point, the trigger setting information is displayed at the upper right corner of the screen. For example,

. The trigger type is CAN trigger; the trigger source is CH1; the trigger level is 0.00 V.

### Source Selection:

Press **Source** to open the signal source list and select CH1 or CH2. For the details, please refer to the introduction in "**Trigger Source**". The current trigger source is displayed at the upper right corner of the screen.

**Note:** Select channel with signal input as trigger source to obtain stable trigger.

### Signal Type:

Press **Signal Type** to select the desired signal type.

- **Rx**: receiving signal on the CAN signal line.
- **Tx**: transmission signal on the CAN signal line.
- **CAN\_H**: actual CAN\_H bus signal.
- **CAN\_L**: actual CAN\_L bus signal.
- **Differential**: CAN differential bus signal connected to the analog channel via the differential probe.

### Trigger Condition:

Press **When** to select the desired trigger condition.

- **SOF**: trigger on the start of the data frame.
- **EOF**: trigger on the end of the data frame.
- **Frame Type**: after this type is selected, press **Frame Type** to select to trigger on the "Data", "Remote", "Error" or "OverLoad" frame. Set the following parameters when "Data" or "Remote" is selected.

"Data" trigger:

--press **ID Setup** and select "Specific ID" or "Random ID". When "Specific ID" is selected, press **ID Format** to select "Standard" or "Expand"; press **ID Data** and use  or the inner knob of the navigation knob to adjust the ID data at a relatively smaller step or turn the outer knob of the navigation knob to adjust the ID data at a relatively larger step. The range is from 0 to 2047 (standard ID format) or 0 to 536870911 (expanded ID format).

--press **Byte Length** and use  to input the desired value. The range is from 1 to 8.

--press **CurrentBit** to select the desired data bit and the range is from 0 to ("Byte Length"×8-1).

--press **Data** to set the data pattern of the current bit to X, H or L.

--press **AllBits** to set the data pattern of all the data bits to the data pattern specified in **Data**.

"Remote" trigger:

--press **ID Setup** and select "Specific ID" or "Random ID". When "Specific ID" is selected, press **ID Format** and select "Standard" or "Expand". Press **ID Data** and adjust the ID data using  or the navigation knob by referring to the method mentioned above. The range is from 0 to 2047 (standard ID format) or 0 to 536870911 (expanded ID format).

- **Frame Error**: after selecting this type, press **Error Type** to select to trigger on



the "Bit Fill", "Answer Error", "Check Error", "Format Error" or "Random Error".

### Baud:

Press **Baud** to set the CAN baud to match the CAN bus signal and the values available are 10 kb/s (default), 20 kb/s, 33.3 kb/s, 50 kb/s, 62.5 kb/s, 83.3 kb/s, 100 kb/s, 125 kb/s, 250 kb/s, 500 kb/s, 800 kb/s, 1 Mb/s or User. After "User" is selected, press **User** and use  or the inner knob of the navigation knob to modify the baud rate at a relatively smaller step or turn the outer knob of the navigation knob to adjust the baud rate at a relatively larger step. The adjustable range is from 10 kb/s to 1 Mb/s.

### Sample Point:

Sample point is a point within a bit's time. The oscilloscope samples the bit level at this point. The sample position is represented by the percentage of "the time from the start of the bit's time to the sample point time" in the "bit's time".

Press **SamplePoint** and use  to modify the parameter with a step of 1% and the range is from 5% to 95%.

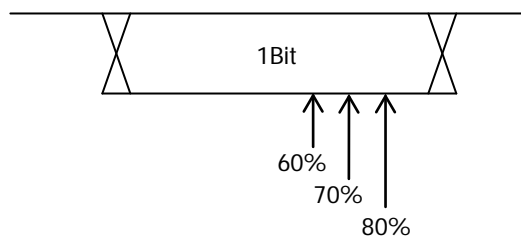

Figure 5-18 Sample Position

### Trigger Mode:

Press **Sweep** to open the trigger mode list and select "Auto", "Normal" or "Single". For the details, please refer to "**Trigger Mode**". The corresponding status light of the current trigger mode turns on.

### Trigger Setting:

Press **Setting** to set the trigger parameters (noise rejection) under this trigger type.

### Trigger Level:

Use **TRIGGER**  **LEVEL** to modify the level. For the details, please refer to the introduction of "**Trigger Level**".

## Trigger Output Connector

The trigger output connector (**[Trigger Out]**) on the rear panel of the oscilloscope can output trigger signals determined by the current setting.

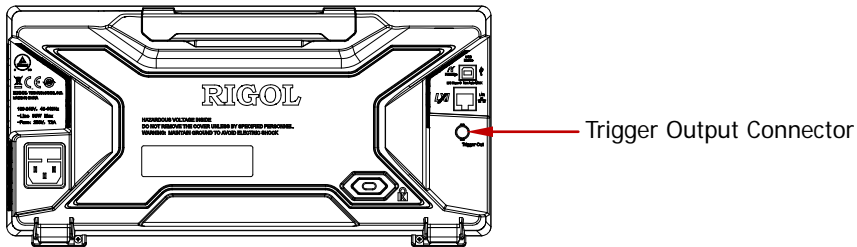

The oscilloscope can output a signal that reflects the current capture rate of the oscilloscope from the **[Trigger Out]** connector each time a trigger is generated. Connect the signal to a waveform display device and measure the signal frequency; the measurement result is the same with the current capture rate.

**Note:** If **Utility** → **AuxOutput** is set to "PassFail" or **Utility** → **Pass/Fail** → **AuxOutput** is set to "ON", during the pass/fail test, the oscilloscope will output a negative pulse through the **[Trigger Out]** connector each time a failure is detected; the oscilloscope will output low level continuously through the **[Trigger Out]** connector when no failure is detected.

## Chapter 6 MATH and Measurements

DS2000E can make math operation, auto measurement and cursor measurement on sampled and displayed data.

The contents of this chapter:

- Math Operation
- Auto Measurement
- Cursor Measurement







## Math Operation

DS2000E can realize various math operations (including: addition (A+B), subtraction (A-B), multiplication (AxB), division (A÷B), FFT, digital filter, logic operation and advanced operation) of waveforms between channels. The results of math operation also allow further measurement.

Press **MATH** → **Operate** in the vertical control area (VERTICAL) on the front panel to select the desired operation function. The result of math operation is displayed on the waveform marked with "M" on the screen.





### Addition



Add the waveform voltage values of signal source A and B point by point and display the results. Press **MATH** → **Operate** to select "A+B":

- Press **Source A** and **Source B** respectively to select the desired channels (CH1 or CH2).
- Press  and use  to adjust the vertical position of the operation results.
- Press  and use  to adjust the vertical scale of the operation results.
- Press **Invert** to turn the inverted display of the operation results on or off.
- Press **Label** to define a label for the operation results. For the details, please refer to "MATH Label".
- **HORIZONTAL**  **POSITION** and **HORIZONTAL**  **SCALE** can also be used to adjust the horizontal position and scale of the operation results.

### Subtraction







Subtract the waveform voltage values of signal source B from that of source A point by point and display the results. Press **MATH** → **Operate** to select "A-B":

- Press **Source A** and **Source B** respectively to select the desired channels (CH1 or CH2).
- Press  and use  to adjust the vertical position of the operation results.
- Press  and use  to adjust the vertical scale of the operation results.
- Press **Invert** to turn the inverted display of the operation results on or off.

- Press **Label** to define a label for the operation results. For the details, please refer to "MATH Label".
- **HORIZONTAL**  **POSITION** and **HORIZONTAL**  **SCALE** can also be used to adjust the horizontal position and scale of the operation results.

## Multiplication

Multiply the waveform voltage values of signal source A and B point by point and display the results. Press **MATH** → **Operate** to select "A x B":





- Press **Source A** and **Source B** respectively to select the desired channels (CH1 or CH2).
- Press  and use  to adjust the vertical position of the operation results.
- Press  and use  to adjust the vertical scale of the operation results.
- Press **Invert** to turn the inverted display of the operation results on or off.
- Press **Label** to define a label for the operation results. For the details, please refer to "MATH Label".
- **HORIZONTAL**  **POSITION** and **HORIZONTAL**  **SCALE** can also be used to adjust the horizontal position and scale of the operation results.

## Division

Divide the waveform voltage values of signal source A by that of source B point by point and display the results. It can be used to analyze the multiple relationships of waveforms in the two channels.

**Note:** When the waveform voltage value of signal source B is 0, the result of the division is treated as 0.

Press **MATH** → **Operate** to select "A ÷ B":

- Press **Source A** and **Source B** respectively to select the desired channels (CH1 or CH2).
- Press  and use  to adjust the vertical position of the operation results.
- Press  and use  to adjust the vertical scale of the operation results.
- Press **Invert** to turn the inverted display of the operation results on or off.
- Press **Label** to define a label for the operation results. For the details, please refer to "MATH Label".

- **HORIZONTAL POSITION** and **HORIZONTAL SCALE** can also be used to adjust the horizontal position and scale of the operation results.

## FFT

FFT is used to quickly perform Fourier transform on specified signals and transform time domain signals to frequency domain signals. The DS2000E series provides FFT operation function which enables users to observe the time domain waveform and spectrum of the signal at the same time. FFT operation can facilitate the following works:

- Measure harmonic components and distortion in the system
- Measure the characteristics of the noise in DC power
- Analyze vibration

Press **MATH** → **Operate** to select "FFT" and set the parameters of FFT operation.

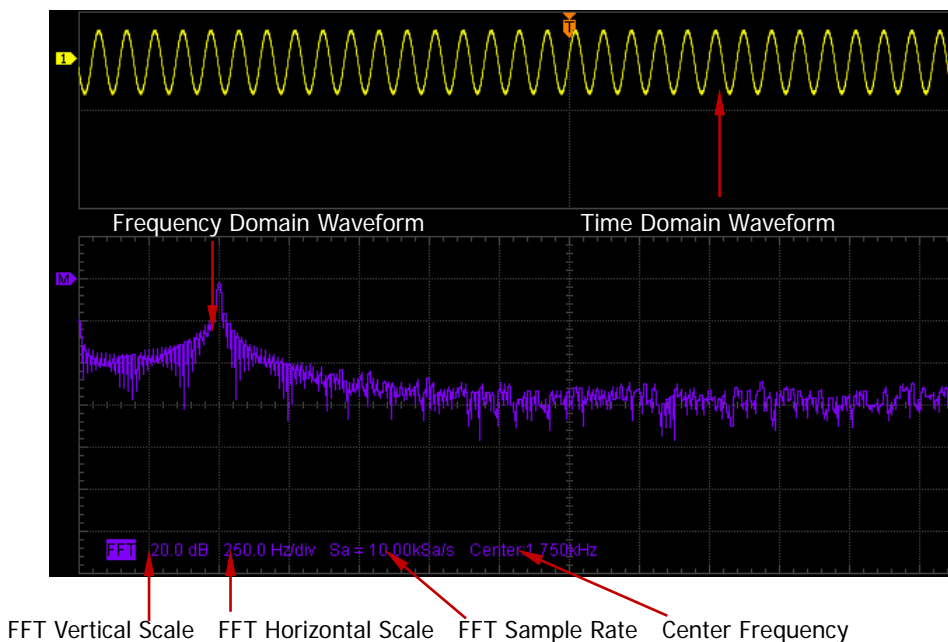

Figure 6-1 FFT Operation

### 1. Select Source

Press **Source** to select the desired channel (CH1 or CH2).

## 2. Select Window Function

Spectral leakage can be considerably decreased when a window function is used. DS2000E provides four kinds of FFT window functions. Different window functions have different characteristics, and are applicable to the measurements of different waveforms. You need to select the window function according to the waveform to be measured and its characteristics. Press **Window** to select the desired window function and the default is "Rectangle".

Table 6-1 Window Functions

Window	Characteristics	Waveforms Suitable for Measurement
Rectangle	The best frequency resolution; the poorest amplitude resolution; similar to the situation when no window is multiplied.	Transient or short pulse, the signal levels before and after the multiplication are basically the same; Sine waveforms with the same amplitude and rather similar frequencies; Wide band random noise with relatively slowly changing waveform spectrum.
Hanning	Better frequency resolution; poorer amplitude resolution.	Sine, periodic and narrow band random noise.
Hamming	A little bit better frequency resolution than Hanning	Transient or short pulse, the signal levels before and after the multiplication are rather different.
Blackman	The best amplitude resolution; the poorest frequency resolution	Single frequency signal, search for higher order harmonics.

## 3. Set the Display Mode

Press **Display** to select "Split" (default) or "Full Screen" display mode.

Split: the source channel and the FFT operation results are displayed separately.



The time domain and frequency domain signals are displayed clearly.

Full Screen: the source channel and the FFT operation results are displayed in

the same window to view the frequency spectrum more clearly and to perform more precise measurement.

**Note:** In FFT mode and when MATH is the active channel, you can also press **HORIZONTAL**  **SCALE** to switch between "Split" and "Full Screen".

#### 4. Set Horizontal Position and Horizontal Scale



The horizontal axis of the FFT operation results represents frequency and its unit is Hz. Use **HORIZONTAL**  **POSITION** and **HORIZONTAL**  **SCALE** to set the horizontal position and horizontal scale of the FFT frequency domain waveform respectively.

**Note:** Setting the horizontal position can changing the center frequency of the FFT operation results indirectly.

#### 5. Set the Vertical Unit

Press **Scale** to set the vertical unit to dB or Vrms and the default is dB. dB and Vrms use logarithmic mode and linear mode to display vertical amplitude respectively. If you need to display the FFT frequency spectrum in a relatively larger dynamic range, dB is recommended.

#### 6. Set Vertical Position and Vertical Scale

Press  and  and use  to set the vertical offset and vertical scale of the FFT frequency domain waveform respectively.

#### 7. Anti-Aliasing

Press **Anti-Aliasing** to enable or disable the anti-aliasing function.

#### 8. Label

Press **Label** to define a label for the operation results. For the details, please refer to "MATH Label".

#### Tips

- Signals with DC components or deviation would cause error or deviation of the FFT waveform components. To reduce the DC components, set the "**Channel Coupling**" to "AC".
- To reduce the random noise and aliasing frequency components of repetitive or single pulse, set the "**Acquisition Mode**" of the oscilloscope to "Average".







## Digital Filter

DS2000E provides 4 types of digital filters (Low Pass Filter, High Pass Filter, Band Pass Filter and Band Reject Filter). The frequencies for the specified waveform band can be filtered by setting the bandwidth range. Press **MATH** → **Operate** to select "Digital Filter" and set the parameters of the digital filter.

### 1. Select the Filter Type

Press **Filter Type** to select the desired filter type.

- : low pass, namely only the signals whose frequency are lower than the current **Upper Limit** can pass the filter.
- : high pass, namely only the signals whose frequency are greater than the current **Lower Limit** can pass the filter.
- : band pass, namely only the signals whose frequency are greater than the current **Lower Limit** and lower than the current **Upper Limit** can pass the filter.
- : band reject, namely only the signals whose frequency are lower than the current **Lower Limit** or greater than the current **Upper Limit** can pass the filter.

### 2. Select the Source

Press **Source** to select the desired channel (CH1 or CH2).

### 3. Set the Bandwidth



When "low pass" filter type is selected, you only need to set the frequency upper limit; when "high pass" filter type is selected, you only need to set the frequency lower limit; when "band pass" or "band reject" filter type is selected, you need to set both the frequency upper limit and lower limit.

**Note:** The settable range of the bandwidth is related to the current horizontal time base.



Press **Upper Limit** and use  to adjust the frequency upper limit of the filter.

Press **Lower Limit** and use  to adjust the frequency lower limit of the filter.

**4. Adjust the Vertical Position and Vertical Scale**

Press  and  respectively and use  to adjust the vertical position and vertical scale of the operation result.

**5. Adjust the Horizontal Position and Horizontal Scale**

Use **HORIZONTAL**  **POSITION** and **HORIZONTAL**  **SCALE** to adjust the horizontal position and horizontal scale of the operation result respectively.

**6. Label**

Press **Label** to define a label for the math operation result. For the details, please refer to the introduction in "**MATH Label**".









## Logic Operation

Perform logic operation on the waveform voltage values of the specified sources point by point and display the results. In operation, when the voltage value of the source channel is greater than the threshold of the corresponding channel, it is regarded as logic "1"; otherwise logic "0". The following common logic operation expressions are provided.

Table 6-2 Logic Operation

Operation	Description															
AND	<p>The results of logic <b>AND</b> operation of two binary bits are as follows:</p> <table> <thead> <tr> <th>A</th> <th>B</th> <th>A AND B</th> </tr> </thead> <tbody> <tr> <td>0</td> <td>0</td> <td>0</td> </tr> <tr> <td>0</td> <td>1</td> <td>0</td> </tr> <tr> <td>1</td> <td>0</td> <td>0</td> </tr> <tr> <td>1</td> <td>1</td> <td>1</td> </tr> </tbody> </table>	A	B	A AND B	0	0	0	0	1	0	1	0	0	1	1	1
A	B	A AND B														
0	0	0														
0	1	0														
1	0	0														
1	1	1														
OR	<p>The results of logic <b>OR</b> operation of two binary bits are as follows:</p> <table> <thead> <tr> <th>A</th> <th>B</th> <th>A OR B</th> </tr> </thead> <tbody> <tr> <td>0</td> <td>0</td> <td>0</td> </tr> <tr> <td>0</td> <td>1</td> <td>1</td> </tr> <tr> <td>1</td> <td>0</td> <td>1</td> </tr> <tr> <td>1</td> <td>1</td> <td>1</td> </tr> </tbody> </table>	A	B	A OR B	0	0	0	0	1	1	1	0	1	1	1	1
A	B	A OR B														
0	0	0														
0	1	1														
1	0	1														
1	1	1														
NOT	<p>The results of logic <b>NOT</b> operation of one binary bit are as follows:</p> <table> <thead> <tr> <th>A</th> <th>NOT A</th> </tr> </thead> <tbody> <tr> <td>0</td> <td>1</td> </tr> <tr> <td>1</td> <td>0</td> </tr> </tbody> </table>	A	NOT A	0	1	1	0									
A	NOT A															
0	1															
1	0															
XOR	<p>The results of logic <b>XOR</b> operation of two binary bits are as follows:</p> <table> <thead> <tr> <th>A</th> <th>B</th> <th>A XOR B</th> </tr> </thead> <tbody> <tr> <td>0</td> <td>0</td> <td>0</td> </tr> <tr> <td>0</td> <td>1</td> <td>1</td> </tr> <tr> <td>1</td> <td>0</td> <td>1</td> </tr> <tr> <td>1</td> <td>1</td> <td>0</td> </tr> </tbody> </table>	A	B	A XOR B	0	0	0	0	1	1	1	0	1	1	1	0
A	B	A XOR B														
0	0	0														
0	1	1														
1	0	1														
1	1	0														

Press **MATH** → **Operate** to select "Logic":

- Press **Formula** to select the desired logic formula and the default is "AND".
- Press **Source A** and **Source B** respectively to select the desired channels (CH1 or CH2).
- Press  and use  to adjust the vertical position of the operation results.
- Press  and use  to adjust the vertical scale of the operation results.
- Press **Invert** to turn the inverted display of the operation results on or off.
- Press **Threshold A** and use  to set the threshold of source A in logic operation.
- Press **Threshold B** and use  to set the threshold of source B in logic operation.
- Press **Label** to define a label for the operation results. For the details, please refer to "MATH Label".
- **HORIZONTAL  POSITION** and **HORIZONTAL  SCALE** can also be used to adjust the horizontal position and scale of the operation results.

## Advanced Operation

DS2000E provides advanced operation function that allows users to define operation functions. Press **MATH** → **Operate** → "Advanced" → **Expression** → "ON" and the editing window as shown in the figure below is displayed.



Figure 6-2 Advanced Operation Editing Window

Turn  to select any item in "Channel", "Function", "Variable", "Operator" and "Figure" (the items in white can be selected currently and the items in gray cannot be selected currently), then press down the knob and the item selected will be displayed in the entry box on the right of the "Expression".

During the expression editing, you can press **Delete** to delete the character currently at the left of the cursor and press **Clear** to delete all the characters in the entry box at any time. After finishing the expression editing, press **Apply** and the oscilloscope will operate according to the expression you set and display the result.

**Note:** After **Apply** is pressed, the **Expression** menu will be automatically set to "OFF" but the preset expression will still be displayed at the bottom of the screen for your reference.

In addition, you can also press **Invert** to turn the inverted display of the operation results on or off or press **Label** to set label for the math operation results (for the details, refer to the introduction in "**MATH Label**").

The following are descriptions of the contents in the editing window.

### 1. Expression

Here, it refers to the formulas formed by channel, function, variable, operator and figure. The length of the expression should not exceed 64 characters.

### 2. Channel

You can select any channel of CH1 and CH2 or select both of the two channels.

### 3. Function

The functions of the functions are listed in the following table.

**Note:** The left brackets "(" here are only used to facilitate your entry and they are not a part of the function names.

Table 6-3 Functions



Name	Function
Intg(	Calculate the integral of the selected source. You can use integral to measure the area under a waveform or the pulse energy.
Diff(	Calculate the discrete time differential of the selected source. You can use differential to measure the instantaneous slope of a waveform.
Lg(	Calculate the common logarithm of the selected source (use 10 as the base).
Exp(	Calculate the exponent of the selected source. For example, Exp(A) means calculate the Ath power of e.
Sqrt(	Calculate the square root of the selected source.

Sine(	Calculate the sine value of the selected source.
Cosine(	Calculate the cosine value of the selected source.
Tangent(	Calculate the tangent value of the selected source.

#### 4. Variable

Users can set the desired values of Variable1 and Variable2 using the following method.

Press **Variable** to turn on the variable setting menu.

- **Variable:** press this softkey to select the variable to be set as "Variable1" and "Variable2".
- **Step:** press this softkey to set the step used when using  to modify the "Mantissa". The steps available are  $\times 1$ ,  $\times 0.1$ ,  $\times 0.01$ ,  $\times 0.001$  and  $\times 0.0001$ .
- **Mantissa:** press this softkey and turn  to modify the mantissa at the step specified in **Step**. The range available is from -9.9999 to 9.9999.
- **Exponent:** press this softkey to set the numeric values of the exponents with 10 as the bottom number in the variables. The range is from -9 to 9.

For example, Variable1 is set to  $6.1074 \times 10^8$  via the following settings.

Variable: Variable1

Mantissa: 6.1074

Exponent: 8

#### 5. Operator

The functions of the operators are listed in the following table.

Table 6-4 Operators



Operator	Function
+ - * /	Arithmetic operators: add, subtract, multiply and divide
( )	Parentheses: used to increase the priority of the operation enclosed in the parentheses
< > <= >= == !=	Relationship operators: lower than, greater than, lower than or equal to, greater than or equal to, equal to, not equal to
!(    &&	Logic operator: NOT, OR, AND

#### 6. Figure

Select from figure 0 to 9, decimal point and character E. Wherein, character E

represents the  $n$ th power of 10. For example, 1.5E3 means  $1.5 \times 10^3$ .

## MATH Label

The instrument uses  to mark the math operation results by default. For ease of use, you can also set a label for the math operation results, for example, .

Press **MATH** → **Operate** to select the desired math operation and press **Label** to open the label input interface. Then, input the desired label according to the instructions in "**Channel Label**".





**Note:** The user-defined label can include uppercase English letters (from A to Z), lowercase English letters (from a to z), numbers (from 0 to 9), underline and space; the length of the label cannot exceed 4 characters.

## Auto Measurement

DS2000E provides auto measurements of 29 waveform parameters and the statistics and analysis of the measurement results. What's more, you can also use the frequency counter to realize more precise frequency measurement.

### Quick Measurement after AUTO

When a valid signal is input into the oscilloscope, press **AUTO** to enable the waveform auto setting function and open the auto setting menu.

- : press this softkey and the oscilloscope automatically displays a single period of the signal on the screen and measures the "Period" and "Frequency" of the single period waveform currently displayed. The measurement results are displayed at the bottom of the screen.
- : press this softkey and the oscilloscope automatically displays multiple periods of the signal on the screen and measures the "Period" and "Frequency" of the multiple-period waveform currently displayed. The measurement results are displayed at the bottom of the screen.
- : press this softkey and the oscilloscope automatically displays a rising edge of the signal on the screen and measures the "Rise Time" of the rising edge currently displayed. The measurement result is displayed at the bottom of the screen.
- : press this softkey and the oscilloscope automatically displays a falling edge of the signal on the screen and measures the "Fall Time" of the falling edge currently displayed. The measurement result is displayed at the bottom of the screen.
- Pressing **Undo** softkey will automatically give up the auto setting and restore the parameter settings before **AUTO** is pressed.

Besides, you can set the channel coupling mode after AUTO operation (please refer to "**Auto Setting**").



**Note:** The waveform auto setting function requires that the frequency of the sine should be no lower than 25 Hz. If the parameter exceeds the limit, the waveform auto setting function might be invalid.

## One-key Measurement of 29 Parameters

Press **MENU** at the left of the screen to turn on the measurement menu of the 29 parameters and then press the corresponding menu softkey to quickly realize "One-key" measurement. The measurement result will be displayed at the bottom of the screen.

**Note:** Press **Measure** → **Source** to select the current measurement source.

The menu item icons and measurement results of time, voltage and area parameters are always in the same color as the current measurement channel (**Measure** → **Source**). The menu item icons and measurement results of delay and phase parameters are always indicated in white; the menu item icons and the number in the results denote source A and source B currently selected (the color of the number is the same as that of the selected channel).

**Note:** If the measurement result is displayed as "\*\*\*\*\*", there is no signal input into the current measurement source or the measurement result is out of the valid range (too large or too small).

## Time Parameters

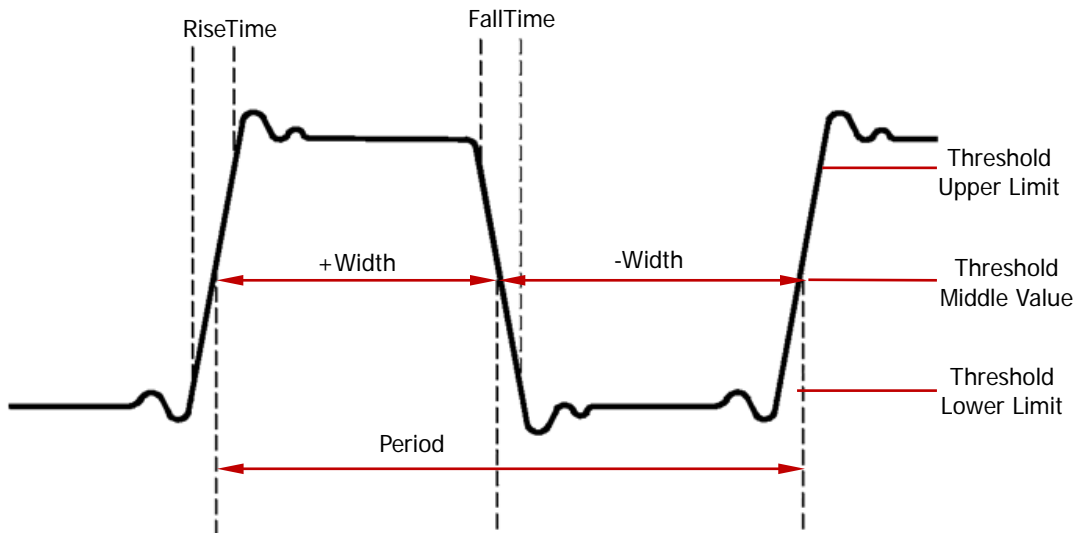

Figure 6-3 Time Parameters

1. **Period:** the time between the threshold middle value of one edge and the threshold middle value of the next edge with the same polarity.
2. **Frequency:** defined as the reciprocal of period.
3. **Rise Time:** the time for the signal amplitude to rise from the threshold lower limit to the threshold upper limit of the rising edge.
4. **Fall Time:** the time for the signal amplitude to fall from the threshold upper limit to the threshold lower limit of the falling edge.
5. **+ Width:** the time difference between the threshold middle value of a rising edge and the threshold middle value of the next falling edge of the pulse.
6. **- Width:** the time difference between the threshold middle value of a falling edge and the threshold middle value of the next rising edge of the pulse.
7. **+ Duty:** the ratio of the positive pulse width to the period.
8. **- Duty:** the ratio of the negative pulse width to the period.

**Note:** The default values of the threshold upper limit, threshold middle value and threshold lower limit in the figure above are 90%, 50% and 10% respectively. You can set them via **Measure** → **Setting** → **Type** → "Threshold" and for the setting method, please refer to the introduction in "**Threshold Measurement Setting**".

## Delay and Phase

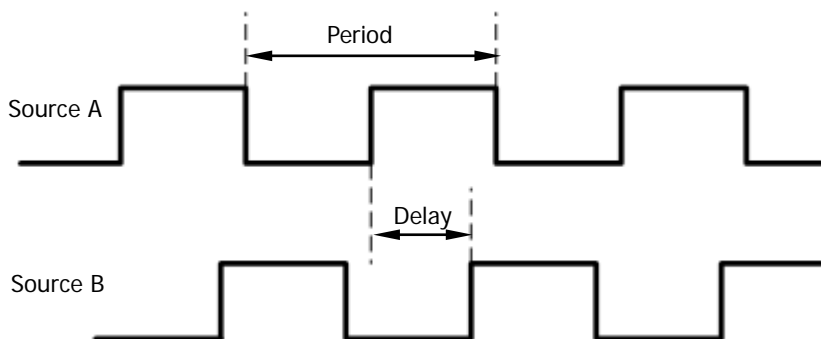

Figure 6-4 Delay and Phase

Source A and source B can be either CH1 or CH2. You can set them via **Measure** → **Setting** → **Type** → "Delay" ("Phase"). For the setting method, refer to "Measurement Setting".

1. **Dly A<sup>f</sup> → B<sup>f</sup>**: the time difference between the threshold middle values of the rising edges of source A and source B.
2. **Dly A<sup>t</sup> → B<sup>t</sup>**: the time difference between the threshold middle values of the falling edges of source A and source B.
3. **Dly A<sup>f</sup> → B<sup>t</sup>**: the time difference between the threshold middle values of the rising edge of source A and the falling edge of source B.
4. **Dly A<sup>t</sup> → B<sup>f</sup>**: the time difference between the threshold middle values of the falling edge of source A and the rising edge of source B.
5. **Phs A<sup>f</sup> → B<sup>f</sup>**: the phase difference between the threshold middle values of the rising edges of source A and source B. It can be calculated according to **Dly A<sup>f</sup> → B<sup>f</sup>** and the period of source A.
6. **Phs A<sup>t</sup> → B<sup>t</sup>**: the phase difference between the threshold middle values of the falling edges of source A and source B. It can be calculated according to **Dly A<sup>t</sup> → B<sup>t</sup>** and the period of source A.
7. **Phs A<sup>f</sup> → B<sup>t</sup>**: the phase difference between the threshold middle values of the rising edge of source A and the falling edge of source B. It can be calculated according to **Dly A<sup>f</sup> → B<sup>t</sup>** and the period of source A.
8. **Phs A<sup>t</sup> → B<sup>f</sup>**: the phase difference between the threshold middle values of the falling edge of source A and the rising edge of source B. It can be calculated according to **Dly A<sup>t</sup> → B<sup>f</sup>** and the period of source A.

**Note:**

- Negative delay value/negative phase value indicates that the edge selected of source A occurred after the edge selected of source B.
- Phase is expressed in degree and the calculation formula is as shown below.

$$Phase = \frac{Delay}{PeriodA} \times 360^\circ$$

Wherein, *Phase* is the phase measurement result; *Delay* is the delay measurement result; *PeriodA* is the period of source A.

## Voltage Parameters

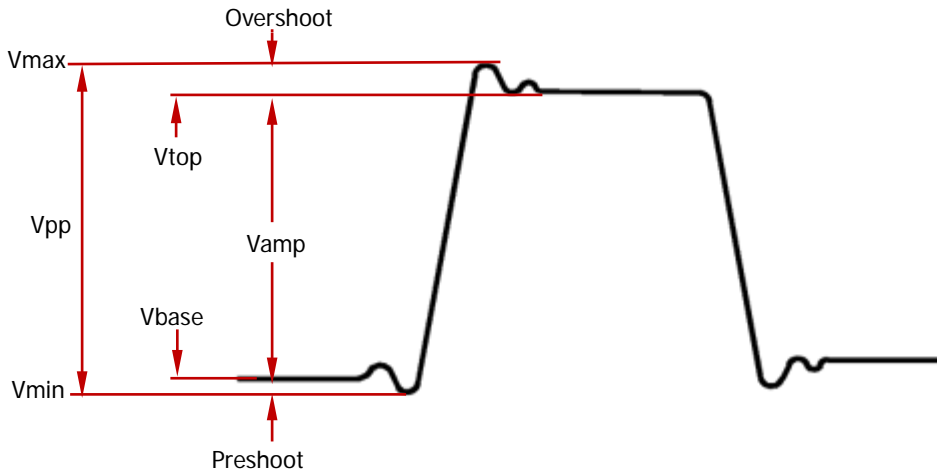

Figure 6-5 Voltage Parameters

1. **Vmax**: the voltage value from the highest point of the waveform to the GND.
2. **Vmin**: the voltage value from the lowest point of the waveform to the GND.
3. **Vpp**: the difference between the maximum value and the minimum value of the waveform.
4. **Vtop**: the voltage value from the flat top of the waveform to the GND.
5. **Vbase**: the voltage value from the flat base of the waveform to the GND.
6. **Vamp**: the difference between the top value and the base value of the waveform.
7. **Vavg**: the arithmetic average value of the voltage values of the waveform points (relative to the GND). The calculation formula is as shown below.

$$Average = \frac{\sum_{i=1}^n x_i}{n}$$

Wherein,  $x_i$  is the measurement result of the  $i^{\text{th}}$  point being measured;  $n$  is the total number of points being measured.

8. **Vrms-N**: the root mean square value of the voltage values of the waveform points (relative to the GND). The calculation formula is as shown below.

$$RMS = \sqrt{\frac{\sum_{i=1}^n x_i^2}{n}}$$

Wherein,  $x_i$  is the measurement result of the  $i^{\text{th}}$  point being measured;  $n$  is the total number of points being measured.

9. **Vrms-1**: the root mean square value of the voltage values of the waveform points (relative to the GND) within a single period. The calculation formula is as shown above.
10. **Overshoot**: the ratio of the difference of the maximum value and top value of the waveform to the amplitude value.
11. **Preshoot**: the ratio of the difference of the minimum value and base value of the waveform to the amplitude value.

## Area Parameters

1. **Area**: the horizontal axis denotes time and the vertical axis denotes waveform amplitude. The oscilloscope calculates the area of the waveform (namely the integral of the time and amplitude). The unit is volt-second. The area of the waveform above the zero reference (namely the vertical offset) is positive and the area of the waveform below the zero reference is negative. The area measured is the algebraic sum of the area of the waveform within the current measurement range.
2. **Per.Area**: period area; the horizontal axis denotes time and the vertical axis denotes waveform amplitude. The oscilloscope calculates the area of the waveform (namely the integral of the time and amplitude) within a single period. The unit is volt-second. The area of the waveform above the zero reference (namely the vertical offset) is positive and the area of the waveform below the zero reference is negative. The area measured is the algebraic sum of the area of the waveform within a single period.

## Frequency Counter Measurement

The hardware frequency counter supplied with the DS2000E oscilloscope can make more precise measurement of the input signal frequency.

Press **Measure** → **Counter** to select CH1 or CH2 as the measurement source. Besides, the signal input from the **[EXT TRIG]** connector can also be used as the measurement source. The measurement result is displayed at the upper right corner of the screen and you can identify the current measurement source according to the color of the icon. The following figure is the result of frequency measurement of the input signal of CH1.



Select "OFF" to disable the frequency counter measurement function.

**Note:** When the frequency of the input signal of the measurement source is lower than 15 Hz, the measurement result displayed is "< 15 Hz".





## Measurement Setting

### 1. Source Selection

Press **Measure** → **Source** to select the source channel (CH1, CH2, or MATH) of the time, voltage or area parameter. The color of the parameter icons under **MENU** at the left of the screen will change with the source selected.

### 2. Measurement Range

Press **Measure** → **Range** → **Range** to select "Screen" or "Cursor" for measurement.

When "Cursor" is selected, two cursor lines appear on the screen. At this point, press **CursorA** and **CursorB** and use  to adjust the position of the two cursor lines respectively so as to determine the measurement range. Or, press **CursorAB** and use  to adjust the positions of cursor A and cursor B at the same time.

**Note:** You can press  continuously to switch among **CursorA**, **CursorB** and **CursorAB**.

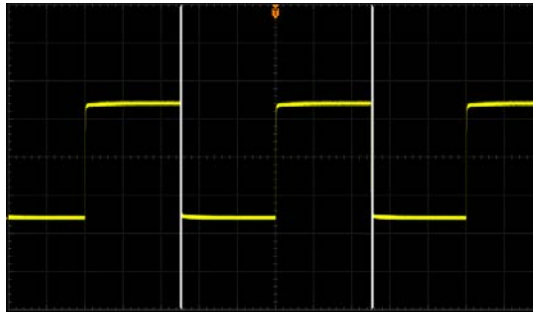

Figure 6-6 Cursor Region

### 3. Delayed Measurement Setting

Specify source A and source B in the measurement items "**Dly A<sup>f</sup> → B<sup>f</sup>**", "**Dly A<sup>t</sup> → B<sup>t</sup>**", "**Dly A<sup>f</sup> → B<sup>t</sup>**" and "**Dly A<sup>t</sup> → B<sup>f</sup>**".

Press **Measure** → **Setting** → **Type** → "Delay" and then press **SourceA** and **SourceB** to set the two channel sources (CH1 or CH2) of the delayed measurement respectively.

#### 4. Phase Measurement Setting



Specify source A and source B in the measurement items "**Phs A $f$  → B $f$** ", "**Phs A $t$  → B $t$** ", "**Phs A $f$  → B $t$** " and "**Phs A $t$  → B $f$** ".

Press **Measure** → **Setting** → **Type** → "Phase" and then press **SourceA** and **SourceB** to set the two channel sources (CH1 or CH2) of the phase measurement respectively.

#### 5. Threshold Measurement Setting

Specify the upper limit, lower limit and middle value of the auto measurement of the analog channel. Measurements of all the time, delay and phase parameters will be influenced by this setting.

Press **Measure** → **Setting** → **Type** → "Threshold" and then:

- Press **Max** and use  to set the maximum value of the measurement. Reducing the maximum value to the current "Mid" will automatically reduce "Mid" ("Min" might also be included) to keep it (them) lower than the maximum value. The default is 90% and the range available is from 7% to 95%.
- Press **Mid** and use  to set the middle value of measurement. The middle value is limited by the settings of "Max" and "Min". The default is 50% and the range available is from 6% to 94%.
- Press **Min** and use  to set the minimum value of the measurement. Increasing the minimum value to the current "Mid" will automatically increase "Mid" ("Max" might also be included) to keep it (them) higher than the minimum value. The default is 10% and the range available is from 5% to 93%.

#### 6. High-Low Measurement Setting

Set the top value (high) and base value (low) of the auto measurement of the analog channel. Setting the high and low values will affect the measurements for all the parameters such as time, voltage, delay, and phase.

Press **Measure** → **Setting** → **Type** → "High-Low" and then:

- Press **Auto** to select "ON", and then the oscilloscope will automatically select the most proper top value and base value based on the current configuration condition.
- Press **Auto** to select "OFF", and then users can self-define the top value and base value based on the actual waveforms under test and the measurement demand.

Press **Vtop** to select "Histogram" or "Vmax".

- Histogram: takes the voltage between the flat top of the waveform and the GND as the top value.
- Vmax: takes the maximum value of the waveform data as the top value.

Press **Vbase** to select "Histogram" or "Vmin".

- Histogram: takes the voltage between the flat base of the waveform and the GND as the base value.
- Vmin: takes the minimum value of the waveform data as the base value.

## To Clear the Measurement

If you have currently enabled one or more items in the 29 measurement parameters, you can "Delete" or "Recover" the last five parameters or "Delete" or "Recover" all the measurement items enabled.

**Note:** The last five parameters are determined according to the order in which you turned them on and they will not change as you delete one or more measurement items.

Press **Measure** → **Clear** → **Item n** (n=1~5) to "Delete" or "Recover" the specified measurement item. When one measurement item is deleted or recovered, the measurement result at the bottom of the screen will move one-item left or right.

Press **Measure** → **Clear** → **All Items** to "Delete" or "Recover" the last five parameters.

**Note:** Press and hold **Measure** to quickly clear or restore the last five parameters.

## All Measurement

All measurement could measure all the time and voltage parameters (each measurement source has 21 items, measurements can be performed on CH1, CH2 and MATH at the same time) of the current measurement source and display the results on the screen. Press **Measure** → **Display All** to enable or disable the all measurement function. Press **Measure Source** and use  to select the channel(s) to be measured (CH1, CH2 and MATH).

When multiple "All Measurement" source channels are selected at the same time, the measurement results (the measurement results are in the same color as the channel) will be displayed on the screen from top to bottom in CH1, CH2, and MATH order. If the measurement result is displayed as "\*\*\*\*\*", there is no signal input into the current measurement source or the measurement result is out of the valid range (too large or too small).

### Note:

- When the all measurement function is enabled, "One-key Measurement" is still valid.
- "To Clear the Measurement" will not clear the measurement results of the all measurement.

## Statistic Function

Make statistic and display the current, average, minimum (or standard deviation) and maximum (or count) values of at most 5 measurement items that are turned on last.

Press **Measure** → **Statistic** to turn the statistic function on or off. When the statistic function is enabled, press **Mode** to select "Extremum" or "Difference" measurement. When "Extremum" is selected, the current value, average value, minimum value and maximum value are displayed at the lower side of the screen. When "Difference" is selected, the current value, average value, standard deviation and count value are displayed at the lower side of the screen. Besides, you can press **Reset** to clear the history data and make statistic again.

## Measurement History

To view the history measurement data, press **Measure** → **History** → **History** → "ON". Press **Display** to select the history data display mode.

- Graph: display the measurement results of at most 5 measurement items that are turned on last in graph mode. The measurement points are connected using linear interpolation.
- Table: display the results of the last 10 measurements of at most 5 measurement items that are turned on last in table mode.

## Cursor Measurement

Before making cursor measurements, connect the signal to the oscilloscope and acquire stable display. Cursor measurement can measure the X axis values (usually Time) and Y axis values (usually Voltage) of the selected waveform. All the parameters supported by the "Auto Measurement" function can also be measured through cursors.

The cursor measurement function provides the following two kinds of cursors.

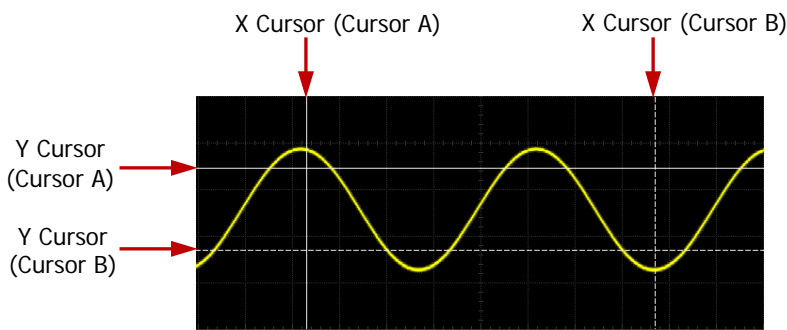

- **X Cursor**

X cursor is a vertical solid/dotted line used to perform horizontal adjustment. It can be used to measure time (s), frequency (Hz), phase ( $^{\circ}$ ) and ratio (%).

- Cursor A is a vertical solid line and cursor B is a vertical dotted line.
- In the X-Y cursor mode, X cursor is used to measure the waveform amplitude of CH1.

- **Y Cursor**

Y cursor is a horizontal solid/dotted line used to perform vertical adjustment. It can be used to measure amplitude (the unit is the same as that of the source channel amplitude) and ratio (%).

- Cursor A is a horizontal solid line and cursor B is a horizontal dotted line.
- In the X-Y cursor mode, Y cursor is used to measure the waveform amplitude of CH2.

Press **Cursor** (in the function menu on the front panel) → **Mode**; use  to select the desired cursor mode (the default is "OFF") and then press down the knob. You can also press **Cursor** or **Mode** continuously to switch the current cursor mode. The

modes available are "Manual", "Track", and "Auto". When "OFF" is selected, the cursor measurement function is turned off. When the "**Time Base Mode**" is "X-Y", only X-Y cursor mode is available.

## Manual Mode

In this mode, you can adjust the cursors manually to measure the X value (or Y value), X increment (or Y increment) between cursors and the reciprocal of X increment on the waveform of the selected source (CH1, CH2 or MATH).

Press **Cursor** → **Mode** → "Manual" to turn the manual cursor measurement function on. The measurement results are displayed at the upper left corner of the screen. You can also press **Cursor** or **Mode** continuously to switch to "Manual". When the measurement parameters are modified, the measurement results will change accordingly.

When the measurement source is CH1, CH2 or MATH, the measurement results are as shown in the figure below.

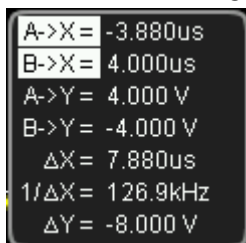

- A->X: the X value at cursor A. X value takes the trigger position as reference. Its unit is "s" or "Hz" (when measuring FFT waveform).
- B->X: the X value at cursor B. X value takes the trigger position as reference. Its unit is "s" or "Hz" (when measuring FFT waveform).
- A->Y: the Y value at cursor A. Y value takes the channel GND as reference. Its unit is the same as that of the current signal source.
- B->Y: the Y value at cursor B. Y value takes the channel GND as reference. Its unit is the same as that of the current signal source.
- ΔX: the horizontal difference between cursor A and B.
- 1/ΔX: the reciprocal of the horizontal difference between cursor A and B.
- ΔY: the vertical difference between cursor A and B.



**Note:** The display mode of the measurement results displayed at the upper left corner of the screen will be different in different cursor display mode, measurement source and units currently selected. When the vertical unit is set to "Source Unit":

- In X (or Y) display mode, A->Y, B->Y and  $\Delta Y$  (or A->X, B->X,  $\Delta X$  and  $1/\Delta X$ ) will not be displayed.
- When the measurement source is MATH (FFT), the units of A->Y and B->Y are "dBV" and the unit of  $\Delta Y$  is "dB".
- When different horizontal unit is selected, the unit of A->X, B->X,  $\Delta X$  and  $1/\Delta X$  is different (for the details, please refer to the introduction below). When the horizontal unit is set to "°" or "%",  $1/\Delta X$  will not be displayed.

### 1. Select Display Mode

Press **DisplayMode** to select "X", "Y" or "X-Y".

- The X cursors are a pair of vertical solid/dotted lines and are usually used to measure time parameters.
- The Y cursors are a pair of horizontal solid/dotted lines and are usually used to measure voltage parameters.
- The X-Y cursors are a pair of vertical solid/dotted lines and a pair of horizontal solid/dotted lines and are usually used to measure time and voltage parameters at the same time.

### 2. Select Measurement Source

Press **Source** to select the waveform of the analog channels (CH1 or CH2) or math operation results (MATH) for measurement. If "None" is selected, no cursor will be displayed.

**Note:** For CH1, CH2, and MATH, only the currently enabled channel can be selected.

### 3. Select Screen Region

- When Zoom is enabled (pressing the **HORIZONTAL**  **SCALE** can enables Zoom), the screen is divided into two regions, Main and Zoom. Press **Screen** to select "Main" or "Zoom". When "Main" is selected, the cursors are displayed in the main region and measure the signal displayed in the main region. The measurement results are displayed in the zoom region. When "Zoom" is selected, the cursors are displayed in the zoom region and measure the signal displayed in the zoom region. The measurement results are displayed in the main region.

**Note:** When the current measurement source is MATH, only the parameters in the Zoom region can be measured.

- When Zoom is disabled, "Main" is automatically selected in **Screen** and cannot be modified.

#### 4. Select X (Y) Axis Unit

**When the measurement source is "CH1", "CH2" or "MATH"**

When the display mode is "X" or "X-Y", press **Time Unit** to select "s", "Hz", "°" or "%".

- s: in the measurement results, A->X, B->X and  $\Delta X$  denote time and  $1/\Delta X$  denotes frequency.
- Hz: in the measurement results, A->X, B->X and  $\Delta X$  denote frequency and  $1/\Delta X$  denotes time.
- °: in the measurement results, A->X, B->X and  $\Delta X$  are expressed in degree. At this point, A->X, B->X and  $\Delta X$  will change to "0°", "360°" and "360°" respectively when you press **SetCursor**, no matter where cursor A and cursor B are currently located. At the same time, two cursor lines (unmovable) appear on the screen as the reference positions.
- %: in the measurement results, A->X, B->X and  $\Delta X$  are expressed in percentage. At this point, A->X, B->X and  $\Delta X$  will change to "0%", "100%" and "100%" respectively when you press **SetCursor**, no matter where cursor A and B are currently located. At the same time, two cursor lines (unmovable) appear on the screen as the reference positions.

**Note:** When the display mode is set to "Y", the **Time Unit** menu will be hidden automatically and cannot be set.

When the display mode is "Y" or "X-Y", press **Vertical Unit** to select "Source Unit" or "%".

- Source Unit: when this unit is selected, in the measurement results, the units of A->Y, B->Y and  $\Delta Y$  will be automatically set to the unit of the current source.
- %: when this unit is selected, in the measurement results, A->Y, B->Y and  $\Delta X$  are expressed in percentage. At this point, A->Y, B->Y and  $\Delta X$  will change to "0%", "100%" and "100%" respectively when you press **SetCursor**, no matter where cursor A and B are currently located. At the same time, two cursor lines (unmovable) appear on the screen as the

reference positions.

**Note:** When the display mode is set to "X", the **Vertical Unit** menu will be hidden automatically and cannot be set.

## 5. Adjust the Cursor Position

- Adjust the horizontal positions of the cursors:  
When the display mode is "X" or "X-Y" (press **SelectCursor** to select "X") mode, press **CursorA** and **CursorB** and use  $\leftarrow$  to adjust the horizontal positions of cursor A and cursor B respectively. Press **CursorAB** and use  $\leftarrow$  to adjust the horizontal positions of cursor A and B at the same time. During the adjustment, the measurement result will change accordingly. The adjustable range is limited within the screen.
- Adjust the vertical positions of the cursors:  
When the display mode is "Y" or "X-Y" (press **SelectCursor** to select "Y") mode, press **CursorA** and **CursorB** and use  $\uparrow$  to adjust the vertical positions of cursor A and cursor B respectively. Press **CursorAB** and use  $\uparrow$  to adjust the vertical positions of cursor A and B at the same time. During the adjustment, the measurement result will change accordingly. The adjustable range is limited within the screen.

## 6. Measurement Example

Use manual cursor measurement to measure the period ( $\Delta X$ ) and frequency ( $1/\Delta X$ ) of a sine waveform and the results are equal to the results from auto measurement.

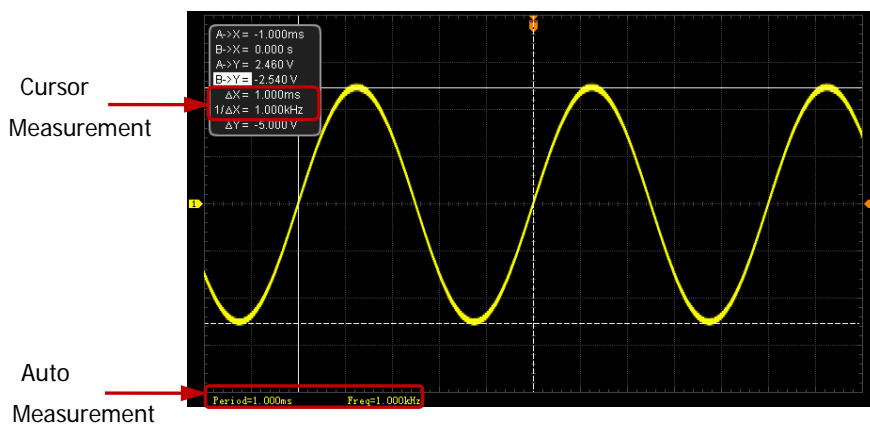
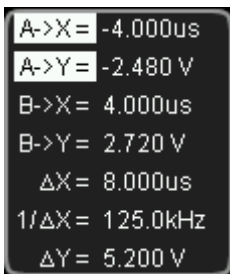

Figure 6-7 Manual Cursor Measurement

## Track Mode

In this mode, you can adjust the two cursors (cursor A and cursor B) to measure the X and Y values on two different sources respectively. The points being measured on cursor A and B are marked by an orange rectangle and rhombus respectively. When the cursors are moved horizontally, the marks will position on the waveform automatically. When the waveform is expanded or compressed horizontally, the marks will track the points being marked at the last adjustment of the cursors.

Press **Cursor** → **Mode** → "Track" to turn on the cursor track function and the measurement results will be displayed at the upper left corner of the screen in the following mode. You can also press **MENU** or **Mode** continuously to switch to "Track". When the measurement parameters are modified, the measurement results will change accordingly.





- A->X: the X value at cursor A. The X value takes the trigger position as reference and "s" or "Hz" (when measuring FFT waveform) as its unit.
- A->Y: the Y value at cursor A. The Y value takes the channel GND as reference and use the same unit as the current source.
- B->X: the X value at cursor B. The X value takes the trigger position as reference and "s" or "Hz" (when measuring FFT waveform) as its unit.
- B->Y: the Y value at cursor B. The Y value takes the channel GND as reference and use the same unit as the current source.
- ΔX: the horizontal difference between cursor A and B.
- 1/ΔX: the reciprocal of the horizontal difference between cursor A and B.
- ΔY: the vertical difference between cursor A and B.

### 1. Select Measurement Source

Press **Cursor A** or **Cursor B** to select the waveform of analog channels (CH1 or CH2) or math operation results (MATH) as the measurement source of cursor A

or cursor B (only channels enabled are available). You can also select "None", namely do not use cursor A or cursor B.

## 2. Adjust Cursor Position

- Adjust cursor A: press **CursorA** and use  to adjust the position of cursor A. During the adjustment, the measurement result will change accordingly. The adjustable range is limited within the screen.
- Adjust cursor B: press **CursorB** and use  to adjust the position of cursor B. During the adjustment, the measurement result will change accordingly. The adjustable range is limited within the screen.
- Adjust cursor A and B at the same time: press **CursorAB** and use  to adjust the position of cursor A and B at the same time. During the adjustment, the measurement results will change accordingly. The adjustable range is limited within the screen.

### Note:

- Under the current menu, you can press  continuously to select **CursorA**, **CursorB** and **CursorAB**.
- When "None" is selected as the measurement source of cursor A (or cursor B), **CursorA** (or **CursorB**) and **CursorAB** will be grayed out.
- In track mode, the cursor will track the marked point (namely jumps up and down with the transient change of the waveform). Thus, the Y value might change even though you do not adjust the cursor.

## 3. Measurement Example

Use cursor A and B to measure the waveforms of CH1 and CH2 respectively. You would discover that the cursors would track the marked points when the waveforms are expanded or compressed horizontally, as shown in the following figure.

### Track Measurement (Before Horizontal Expansion):

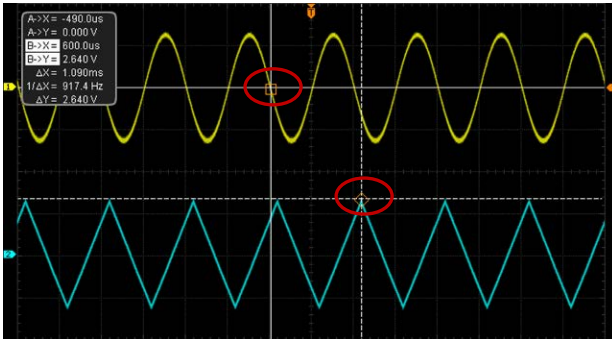

### Track Measurement (After Horizontal Expansion):



## Auto Mode

In this mode, one or more cursors will appear. You can use auto cursor measurement to measure any of the 29 waveform parameters. Before using this mode, you need to at least enable one auto measurement parameter and the number of cursors will change with the measurement parameter enabled.

Press **Cursor** → **Mode** → "Auto" and the number of cursors displayed on the screen is determined by the measurement parameter enabled (different measurement parameter needs different number of cursors).

**Note:** No cursor will be displayed if no auto cursor measurement parameter is enabled or the measurement source has no input. When the waveform is expanded or compressed horizontally, the cursor will move accordingly.

If multiple measurement parameters are turned on later, you can use **Meas.Para.** to switch among at most five measurement parameters that are turned on last and the measurement parameter currently selected is high-lighted at the bottom of the screen.

The following figure shows the auto measurement of the period of CH1.

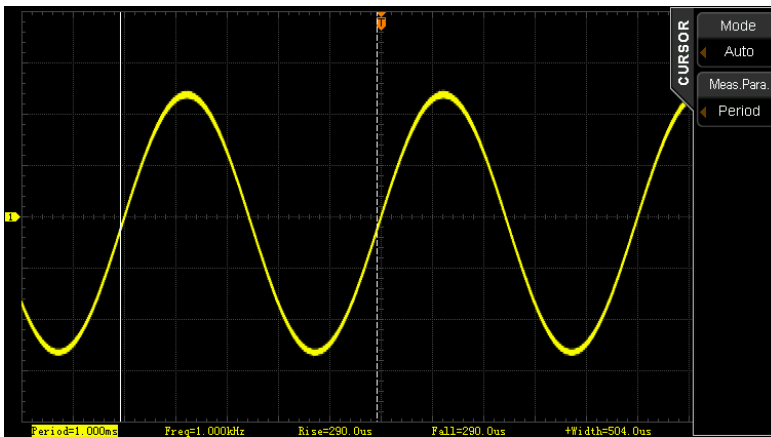

## X-Y Mode

X-Y mode is only available when the main time base is "X-Y" mode. In this mode, you can adjust the cursor to measure X and Y values of the crossing points of the two pairs of cursors.



Press **MENU** at the horizontal control are (HORIZONTAL) on the front panel and then press **Time Base** to select "X-Y". Press **Cursor** → **Mode** → "X-Y" to enable the X-Y mode cursor measurement function. You can also press **Cursor** or **Mode** continuously to switch to "X-Y". The measurement results are displayed at the upper left corner of the screen in the following mode.



```
CurAX = -2.000 V
CurBX = 2.020 V
CurAY = 2.000 V
CurBY = -2.000 V
```

- CurAX: the X value at cursor A.
- CurBX: the X value at cursor B.

- CurAY: the Y value at cursor A.
- CurBY: the Y value at cursor B.

You can adjust the positions of the cursors by the following instructions.

Press **Type** to select "X". Then, press **CursorA** and **CursorB** and use  to adjust the horizontal positions of cursor A and cursor B respectively. Press **CursorAB** and use  to adjust the horizontal position of cursor A and B at the same time. During the adjustment, the measurement result will change accordingly. The adjustable range is limited within the screen.

Press **Type** to select "Y". Then, press **CursorA** and **CursorB** and use  to adjust the vertical positions of cursor A and cursor B respectively. Press **CursorAB** and use  to adjust the vertical positions of cursor A and cursor B at the same time. During the adjustment, the measurement result will change accordingly. The adjustable range is limited within the screen.



# Chapter 7 Protocol Decoding

Protocol analysis can be used by users to locate errors, debug hardware and accelerate development easily, so as to guarantee quick and high-quality accomplishment of projects. Protocol decoding is the basis of protocol analysis. Only protocol analysis with correct protocol decoding are acceptable. With the correct protocol decoding, more error information can be detected. DS2000E provides two buses to make common protocol decoding (including Parallel (standard), RS232 (option), I2C (option), SPI (option) and CAN (option)) of the analog channel (CH1 or CH2). As the decoding functions and setting methods of the two buses are the same, this chapter only takes Decode1 for illustration.

To get the decoding option information, please refer to the introduction in "**Appendix A: Accessories and Options**".

When you have ordered the decoding option, please refer to the introduction in "**Option Management**" to activate corresponding option.

The contents of this chapter:

- Parallel Decoding
- RS232 Decoding (Option)
- I2C Decoding (Option)
- SPI Decoding (Option)
- CAN Decoding (Option)

## Parallel Decoding

Parallel bus consists of clock line and data line. As shown in the figure below, CLK is the clock line, while Bit0 and Bit1 are the 0 bit and 1st bit on the data line respectively. The oscilloscope will sample the channel data on the rising edge, falling edge or the rising/falling edge of the clock and judge each data point (logic "1" or logic "0") according to the preset threshold level.

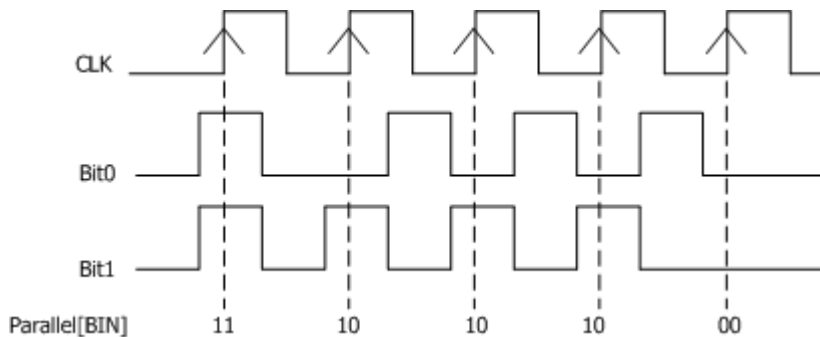

Figure 7-1 Parallel Decoding

Press **Decode1** → **Decode** to select "Parallel" and open the parallel decoding function menu.

### 1. Clock Line Setting (CLK)

Press **CLKChannel** to select either of the channel (CH1 or CH2) as the clock channel. If "None" is selected, no clock channel is set.

Press **Slope** to set the oscilloscope to sample the channel data on the rising edge (↗), falling edge (↘) or rising/falling edges (↔). If no clock channel is selected, the instrument will sample when the channel data jumps during the decoding.

### 2. Data Line Setting

- **Set the bus bits**

Press **Bus Bits** to set the data width of the parallel bus namely the number of bits per frame. The default is 1 and the maximum is 2 bits (Bit0 and Bit1).



- **Specify data channel for each bit.**

First, press **CurrentBit** to select the bit that needs to specify channel. The default is 0 and the range available is from 0 to (the bus bits-1).

Next, press **Channel** to specify a channel source for the bit currently selected in **CurrentBit**. The channel source can be CH1 or CH2.

### 3. Analog Channel Threshold Setting

Press **Threshold** to open the threshold setting menu.

- Press **Channel** to select the desired channel (CH1 or CH2).
- Press **TTL**, **CMOS** or **ECL** to set the threshold of the specified channel to the corresponding level value; or press **Threshold** and use  to set the threshold. The settable range is from  $(-5 * \text{vertical scale} - \text{vertical position})$  to  $(5 * \text{vertical scale} - \text{vertical position})$ . The default is 0 V. Pressing down  can quickly reset the threshold level to 0 V.

**Note:** When the threshold selected is beyond the specified range, it will be automatically limited within the range.

### 4. Display-related Setting

Press **Format** to set the display format of the bus to Hex, Decimal, Binary or ASCII.

Press **Offset** and use  to adjust the vertical display position of the bus.

Press **BusStatus** to turn the bus display on or off.

### 5. Event Table

The event table displays the decoded data and the corresponding line number and time in table format. It can be used to observe relatively longer decoded data. Press **Event Table** → **Event Table** to select "ON" (This operation is only available when **BusStatus** is set to "ON") to enter the event table interface as shown in Figure 7-2.

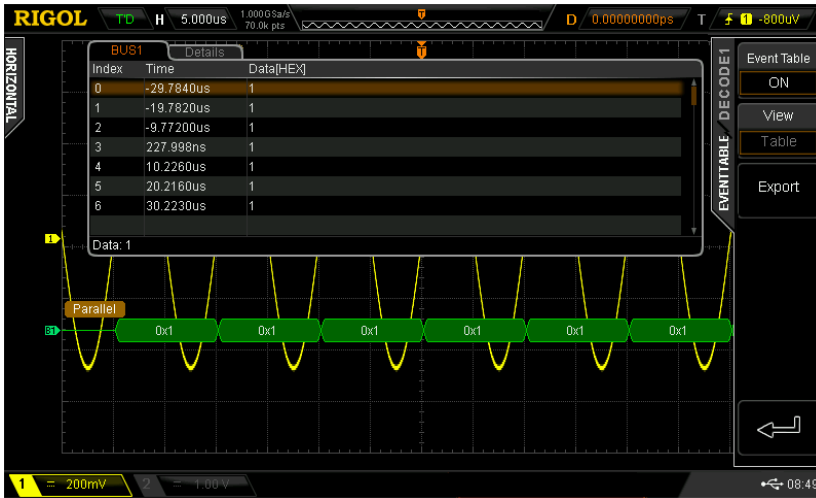

Figure 7-2 Parallel Event Table

At this point, "Table" is selected in the **View** menu automatically and the menu is grayed out. The decoded data is displayed in table format following the time order. If an USB storage device is currently connected to the instrument, press **Export** to export the data table to the external USB storage device in CSV format.

## RS232 Decoding (Option)

RS232 serial bus consists of the transmitting data line (TX) and the receiving data line (RX).

The industry standard of RS232 uses "Negative Logic", namely high level is logic "0" and low level is logic "1".

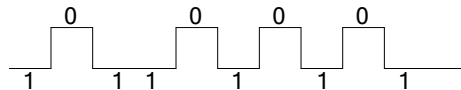
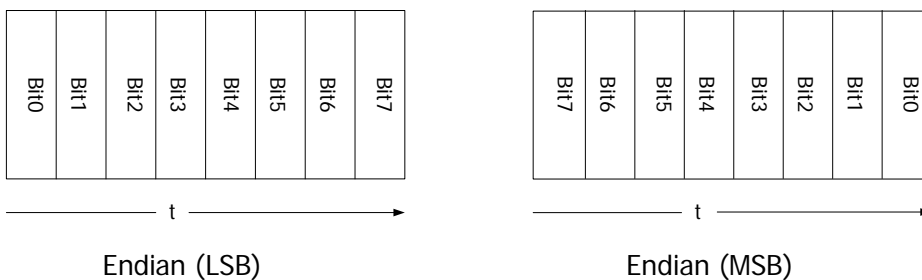

Figure 7-3 RS232 Industrial Standard Schematic Diagram

By default, RS232 uses LSB (Least Significant Bit) transmission sequence, namely the lowest bit of the data is transmitted first. While for MSB (Most Significant Bit), the highest bit of the data is transmitted first.



In RS232, you need to set the start bit, data bits, check bit (optional) and stop bit of each frame of data.

**Start Bit:** represent when the data starts outputting.

**Data Bits:** represent the number of data bits actually contained in each frame of data.

**Check Bit:** used to check the correctness of the data transmission.

- Odd Checkout: the total number of "1" in the data bit and check bit is an odd. For example, when 0x55 (01010101) is sent, a 1 needs to be filled in the check bit to make the number of 1 be an odd.
- Even Checkout: the total number of "1" in the data bit and check bit is an even. For example, when 0x55 (01010101) is sent, a 0 should be filled in the check bit.
- None: there would not be check bit during the transmission.

**Stop Bit:** represent when the data stops outputting.

Press **Decode1** → **Decode** to select "RS232" to open the RS232 decoding function menu.

If the current trigger type of the trigger system is RS232, pressing **CopyTrig** can copy the current RS232 trigger settings (include the source channel, polarity, stop bit, even-odd check mode, data bits and baud rate) and apply them to the RS232 decoding function. Then, if needed, you can still set the RS232 decoding parameters according to the introductions below.

**Note:** The copy function is only available when the current trigger type is "RS232"; otherwise, **CopyTrig** is not available.

### 1. TX and RX Channel Setting

Press **TX** to select either of the channel (CH1 or CH2) as the transmitting channel. When "None" is selected, no transmitting channel is set. Use the same method the set the **RX** channel.

When an analog channel is selected for **TX** or **RX**, you need to set a threshold by pressing the **TX** or **RX** menu. The range is from  $(-5 \times \text{vertical scale} - \text{vertical position})$  to  $(5 \times \text{vertical scale} - \text{vertical position})$  and the default is 0 V.

### 2. Polarity Setting

Press **Polarity** to select "Normal" (negative logic, namely the high level is logic "0" and the low level is logic "1") or "Invert" (positive logic, namely the high level is logic "1" and the low level is logic "0") and the default is "Normal".

### 3. Endian Setting

Press **Endian** to select "LSB" or "MSB" and the default is "LSB".

### 4. Baud Rate Setting

Press **Baud** to select the desired baud rate and the default is 9600 bps. If "User" is selected, press **Setup** and use  or the inner knob of the navigation knob to adjust the baud rate at a relatively smaller step or turn the outer knob of the navigation knob to adjust the baud rate at a relatively larger step. The range is from 110 bps to 20 Mbps.

### 5. Data Packet Setting

As mentioned before, in RS232, you need to set the start bit, data bits, check bit (optional) and stop bit of each frame of data. "Start Bit" is specified by the

"Polarity Setting". The setting methods of other parameters are as follows.

- Press **Data Bits** to set the data width of each frame. It can be set to 5, 6, 7, 8 or 9 and the default is 8.
- Press **Stop Bit** to set the stop bit after each frame of data. It can be set to 1 bit, 1.5 bit or 2 bit.
- Press **Even-Odd** to set the even-odd check mode of the data transmission. It can be set to None, Odd or Even.
- Press **Packet** to enable or disable the packet end. When packet end is enabled, several data blocks are combined according to the packet end.
- Press **PacketEnd** to set the packet end during data transmission and it can be set to 00 (NULL), 0A (LF), 0D (CR), 20 (SP) or FF.

## 6. Display-related Setting

Press **Format** to set the display format of the bus to Hex, Decimal, Binary or ASCII.

Press **Offset** and use  to adjust the vertical display position of the bus.

Press **BusStatus** to turn the bus display on or off.

## 7. Event Table

The event table displays the decoded data, the corresponding line number, time and error information on TX and/or RX data lines in table format. It can be used to observe relatively longer decoded data.

**Note:** When the **RX** or **TX** channel is set to "None", the information of this data line will not be displayed in the event table.

Press **Event Table** → **Event Table** to select "ON" (This operation is only available when **BusStatus** is set to "ON") to enter the event table interface as shown in the figure below.

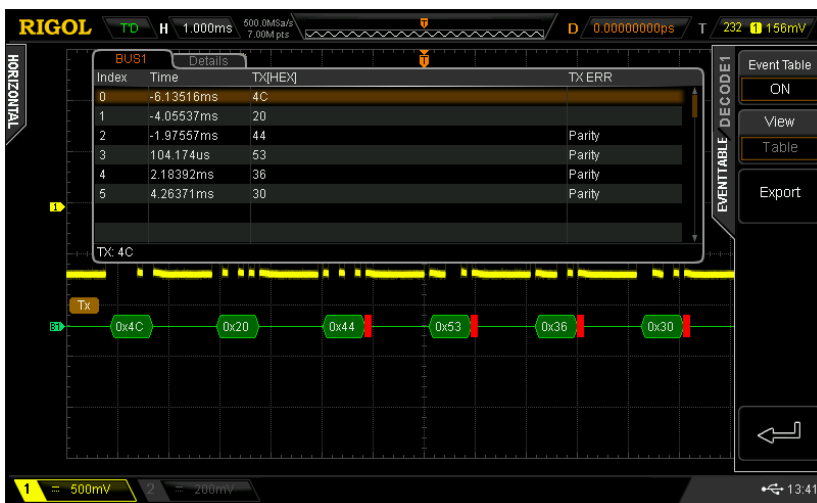



Figure 7-4 RS232 Event Table

At this point, "Table" is selected in the **View** menu automatically and the menu is grayed out. The event data is displayed in table format following the time order. If error occurs during the decoding, the corresponding error information is displayed. If a USB storage device is currently connected to the instrument, press **Export** to export the data table to the external USB storage device in CSV format.

### 8. The Error Expression during Decoding

DS2000E makes full use of the resources such as color and view to express the results of the protocol decoding effectively so as to let users find the desired information quickly.

#### End Frame Error:

Errors generated when the end frame condition is not met. When the stop bit is set to 1.5, red error mark (**Note:** The red mark is displayed in different modes according to the horizontal time base setting; when the horizontal time base is relatively smaller,  is displayed; otherwise,  is displayed) will be displayed if the stop bit is less than 1.5.

#### Check Error:

When check bit error is detected during the decoding, red error mark will be displayed. For example, when the transmitting terminal is set to none check and



the decoder is set to odd check, the following check error occurs.

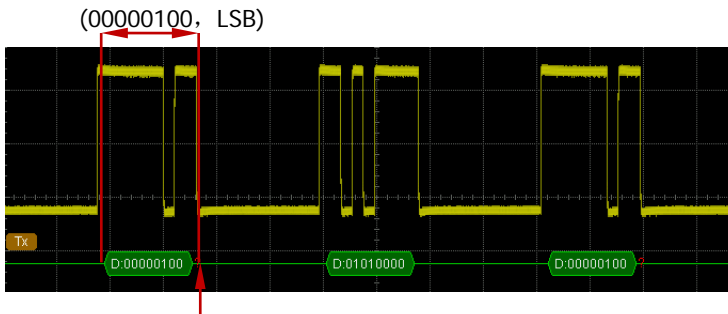

The check bit detected is 1

Wherein, there are odd number (1) of 1 in the 8-bit data 00000100 and the check bit should be 0; but the check bit detected on the TX is 1, thus check error occurs.

After the decoder is set to none check, the decoding becomes normal.

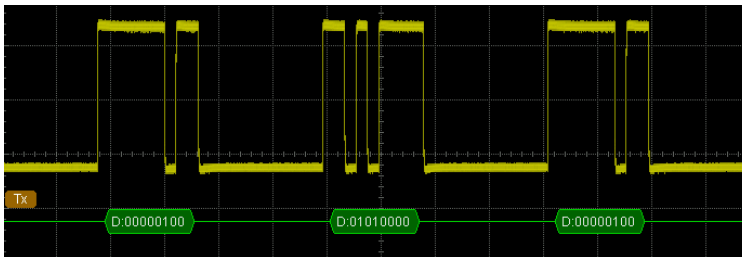

**Note:** Two error marks will be displayed when end frame error and check error are detected at the same time.

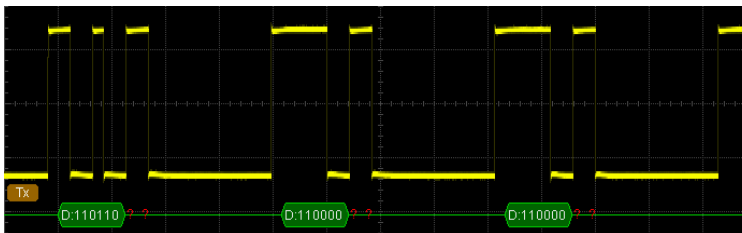

## I2C Decoding (Option)

I2C serial bus consists of the clock line (SCLK) and the data line (SDA).

**SCLK**: sample the SDA on the clock rising edge or falling edge.

**SDA**: denote the data channel.

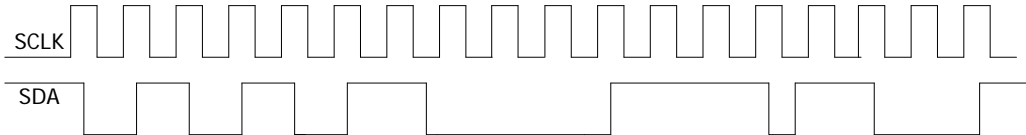

Figure 7-5 I2C Serial Bus

Press **Decode1** → **Decode** to select "I2C" and open the I2C decoding function menu.

If the current trigger type of the trigger system is I2C, pressing **CopyTrig** softkey can copy the current I2C trigger settings (include the clock signal and data signal) and apply them to the I2C decoding function. Then, if needed, you can still set the I2C decoding parameters according to the introductions below.

**Note:** The copy function is only available when the current trigger type is "I2C"; otherwise, **CopyTrig** is not available.

### 1. SCLK Setting

Press **SCLK** to select either of the channel (CH1 or CH2) as the clock channel.

Press **SCLKThreshold** to set the threshold of the clock channel. The threshold is related to the vertical position and scale, and the range of the threshold is from  $(-5 \times \text{vertical scale} - \text{vertical position})$  to  $(5 \times \text{vertical scale} - \text{vertical position})$ .

### 2. SDA Setting

Press **SDA** to select either of the channel (CH1 or CH2) as the data channel.

Press **SDAThreshold** to set the threshold of the data channel. The threshold is related to the vertical position and scale, and the range of the threshold is from  $(-5 \times \text{vertical scale} - \text{vertical position})$  to  $(5 \times \text{vertical scale} - \text{vertical position})$ .

### 3. Display-related Setting

Press **Format** to set the display format of the bus to Hex, Decimal, Binary or

ASCII.

Press **Offset** and use  to adjust the vertical display position of the bus.

Press **BusStatus** to turn the bus display on or off.

#### 4. Event Table

The event table displays the decoded data, the corresponding line number, time, data direction, ID and ACK information in table or details format. Press **Event Table** → **Event Table** to select "ON" (This operation is only available when **BusStatus** is set to "ON") to enter the event table interface.

At this point, you can press **View** to display the event table in "Table" form (as shown in Figure 7-6) or "Details" form (as shown in Figure 7-7). If a USB storage device is currently connected to the instrument, you can press **Export** to export the data table to the external USB storage device in CSV format.

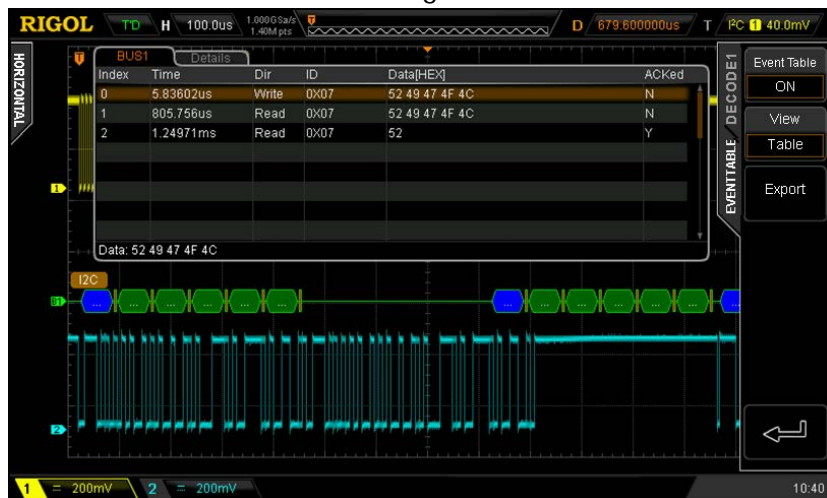

Figure 7-6 I2C Event Table (Table)

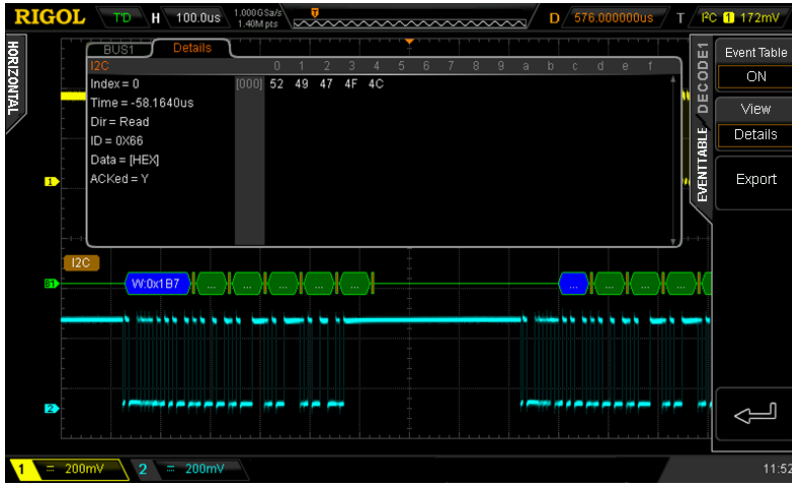
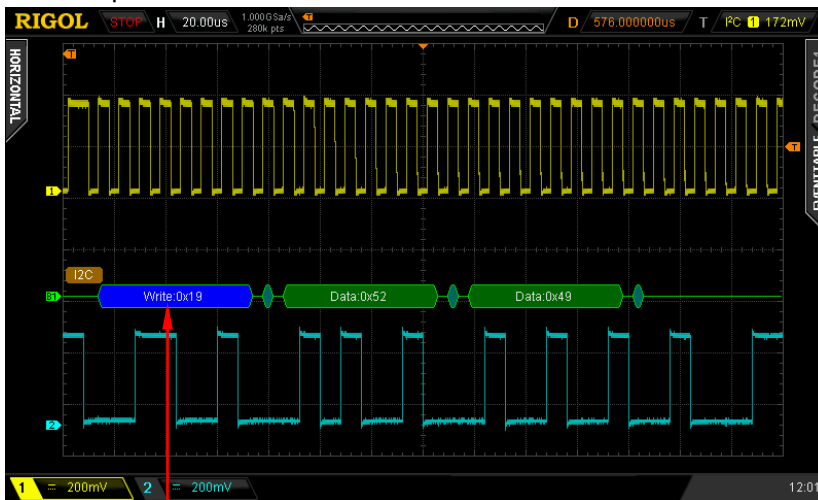

Figure 7-7 I2C Event Table (Details)

### 5. Address Information during Decoding

In I2C bus, the front part of each frame of data contains the address information and blue patches are used to represent address ID. In the ID, "Write" is used to represent writing address and "Read" is used to represent reading address. Press **Include R/W**. When "Open" is selected, "**AddrBits**" will include the "R/W" bit as a part of the address value.



Address Information

Figure 7-8 Address Information during Decoding

## 6. Error Expressions during Decoding

When the ACK (ACKnowledge Character) is not met, the red error marks as shown in the figure below will be displayed. **Note:** The red mark is displayed in different modes according to the horizontal time base setting; when the horizontal time base is relatively smaller, **A:0x1** is displayed; otherwise, **ACK=1** is displayed.

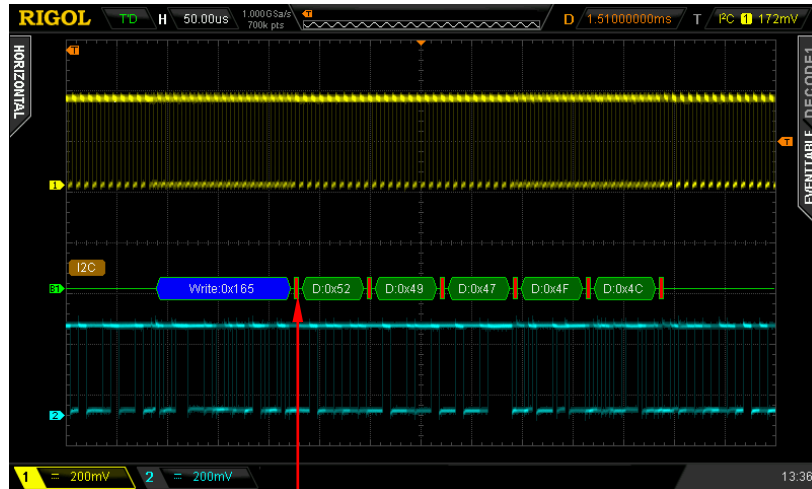

ACK=1

Figure 7-9 Error Expressions during Decoding

## SPI Decoding (Option)

SPI bus consists of clock line (SCLK) and data line (SDA).

**SCLK:** sample the SDA on the clock rising edge or falling edge.

**SDA:** denote the data channel.

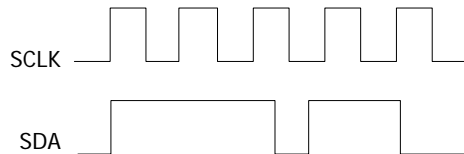

Figure 7-10 SPI Serial Bus

If the current trigger type of the trigger system is SPI, pressing **CopyTrig** can copy the current SPI trigger settings (include the TimeOut mode, clock channel, data channel, data bits and so on) and apply them to the SPI decoding function as well as set the polarity of the SDA data line to high. Then, if needed, you can still set the SPI decoding parameters according to the introductions below.

**Note:** The copy function is only available when the current trigger type is "SPI"; otherwise, **CopyTrig** is not available.

Press **Decode1** → **Decode** to select "SPI" and open the SPI decoding function menu.

### 1. Decoding Mode Setting

The decoding mode of the oscilloscope is "TimeOut" by default, and no other alternatives are available.

Press **TimeOut** and use  or the inner knob of the navigation knob to adjust the timeout time at a relatively smaller step or turn the outer knob of the navigation knob to adjust the timeout time at a relatively larger step. The adjustable range is from 100 ns to 1 s. The default is 1 μs.

### 2. SCLK Setting

Press **SCLK** to enter the clock line setting interface.

- Press **Channel** to select either of the channel (CH1 or CH2) as the clock channel.

- Press **Slope** to set to sample the SDA on the rising or falling edge of the SCLK.
- Press **Threshold** to set the threshold of the clock channel. The threshold is related to the vertical position and scale, and the range of the threshold is from  $(-5 \times \text{vertical scale} - \text{vertical position})$  to  $(5 \times \text{vertical scale} - \text{vertical position})$ .

### 3. SDA Setting

Press **SDA** to enter the SDA data line setting interface.

- Press **Channel** to select either of the channel (CH1 or CH2) as the SDA data channel.
- Press **Polarity** to set the polarity of the SDA data line to **1** (high) or **0** (low).
- Press **Threshold** to set the threshold of the data channel. The threshold is related to the vertical position and scale, and the range of the threshold is from  $(-5 \times \text{vertical scale} - \text{vertical position})$  to  $(5 \times \text{vertical scale} - \text{vertical position})$ .

### 4. Data Bits Setting

Press **Data Bits** to set the number of bits of each frame of data. The range available is from 4 to 32.

### 5. Endian Setting

Press **Endian** to select "LSB" or "MSB" and the default is "MSB".

### 6. Display-related Setting

Press **Format** to set the display format of the bus to Hex, Decimal, Binary or ASCII.

Press **Offset** and use  to adjust the vertical display position of the bus.

Press **BusStatus** to turn the bus display on or off.

### 7. Event Table

The event table displays the decoded data, the corresponding line number, time and error information on the data line in table format. It can be used to observe relatively longer decoded data. Press **Event Table** → **Event Table** to select "ON" (This operation is only available when **BusStatus** is set to "ON") to enter the event table interface as shown in the figure below.

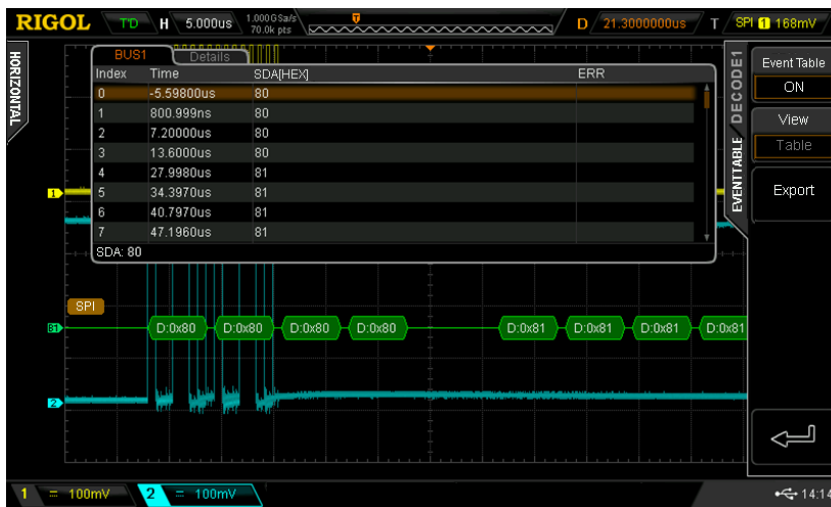

Figure 7-11 SPI Event Table

At this point, "Table" is selected in the **View** menu automatically and the menu is grayed out. The decoded data is displayed in table format following the time order. If a USB storage device is currently connected to the instrument, press **Export** to export the data table to the external USB storage device in CSV format.

### 8. Error Expressions during Decoding

When the clock for a frame in SPI is not enough, the data is filled with red patches. For example, when Data Bits is set to 7 and SCLK slope is set to rising edge, decoding error will be generated.



## CAN Decoding (Option)

You need to specify the CAN signal type and sample position for CAN decoding. The oscilloscope samples the CAN signal on the specified sample position.

Press **Decode1** → **Decode** and select "CAN" to open the CAN decoding function menu.



If the current trigger type of the trigger system is CAN, pressing **CopyTrig** softkey can copy the current CAN trigger settings (include the source channel, signal type, baud rate, sample position and so on) and apply them to the CAN decoding function. Then, if needed, you can still set the CAN decoding parameters according to the introductions below.

**Note:** The copy function is only available when the current trigger type is "CAN"; otherwise, **CopyTrig** is not available.

### 1. Source

Press **Source** to select either of the channel (CH1 or CH2) as the source channel.

At this time, you can set the threshold of the corresponding analog channel.

Press **Threshold** to open the threshold setting menu. Then, press **TTL**, **CMOS** or **ECL** to set the threshold of the specified channel to the corresponding level value; or press **Threshold** and use  to set the threshold. The settable range is from  $(-5 \times \text{vertical scale} - \text{vertical position})$  to  $(5 \times \text{vertical scale} - \text{vertical position})$ . The default is 0 V. Pressing down  can quickly reset the threshold level to 0 V.

**Note:** When the threshold selected is beyond the specified range, it will be automatically limited within the range.

### 2. Signal Type

Press **Signal Type** to select the desired signal type.

- **Rx:** the received signal from the CAN signal line.
- **Tx:** the sending signal from the CAN signal line.
- **CAN\_H:** the actual CAN\_H bus signal.
- **CAN\_L:** the actual CAN\_L bus signal.
- **Differential:** the CAN differential bus signals connected to an analog

channel using a differential probe. The positive lead of the probe connects the CAN\_H bus signal and the negative lead connects the CAN\_L bus signal.

### 3. Baud

Press **Baud** to select a baud rate (100 kb/s, 125 kb/s, 250 kb/s, 400 kb/s, 500 kb/s (default), 800 kb/s, 1 Mb/s or User) that matches the CAN bus signal. When "User" is selected, press **Setup** and use  or the inner knob of the navigation knob to adjust the baud rate at a relatively smaller step or turn the outer knob of the navigation knob to adjust the baud rate at a relatively larger step. The range is from 10 kb/s to 1 Mb/s.

### 4. Sample Point

The Sample point is a point within a bit's time. The oscilloscope samples the bit level at this point. The sample position is represented by the percentage of "the time from the start of the bit's time to the sample point time" in the "bit's time". Press **Sample Point** and use  to adjust this parameter with a step of 1%. The range is from 5% to 95% and the default is 50%.

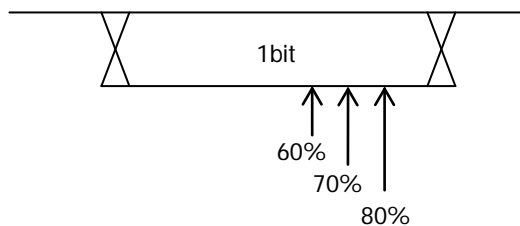



Figure 7-12 Sample Position Schematic Diagram

### 5. Display-related Setting

Press **Format** to set the bus display format to Hex, Decimal, Binary or ASCII.  
 Press **Offset** and use  to adjust the vertical display position of the bus.  
 Press **BusStatus** to enable or disable bus display.

### 6. Event Table

The event table displays the decoded data, the corresponding line number, time, frame ID, DLC, CRC and ACK information in table or details format. Press **Event Table** → **Event Table** to select "ON" (This operation is only available when **BusStatus** is set to "ON") to enter the event table interface.

At this point, you can press **View** to display the event table in "Table" form (as

shown in Figure 7-13) or "Details" form (as shown in Figure 7-14). If a USB storage device is currently connected to the instrument, press **Export** to export the data table to the external USB storage device in CSV format.

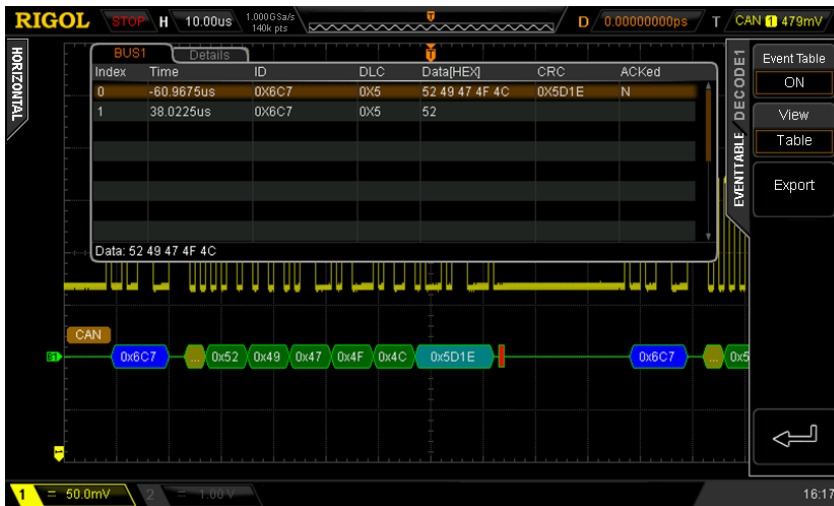

Figure 7-13 CAN Event Table (Table)

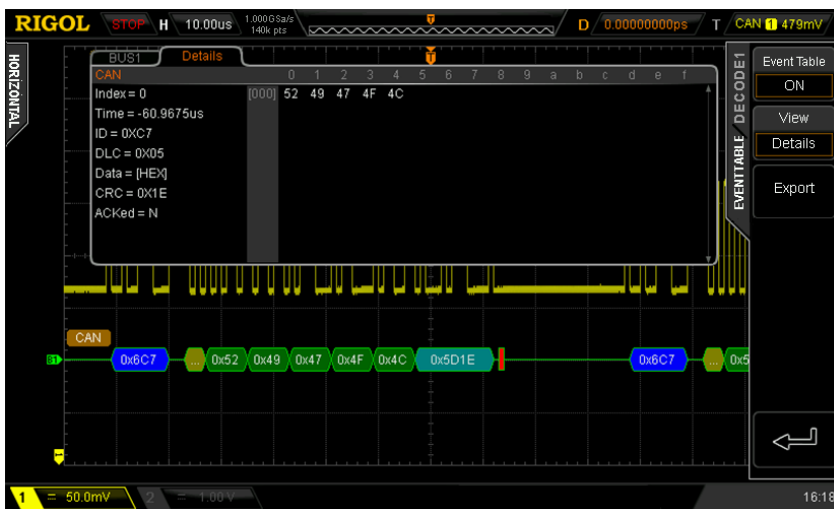

Figure 7-14 CAN Event Table (Details)

## 7. Decoded CAN Data Interpretation

- Frame ID: displayed as hexadecimal number and expressed by blue patch.
- DLC (Data Length Code): displayed as hexadecimal number and expressed by chartreuse patch.

- Data: its display format depends on the format specified in **Format** (hex, decimal, binary or ASCII). It is expressed by green patch. If the data frame is lost, it will be expressed by red patch.
- CRC (Cyclic Redundancy Check): displayed as hexadecimal number. It is expressed by turquoise patch when valid and by red patch when error occurs.
- ACK (Acknowledgement): it is expressed by green patch when valid and by red patch when error occurs (the detected ACK is 1).

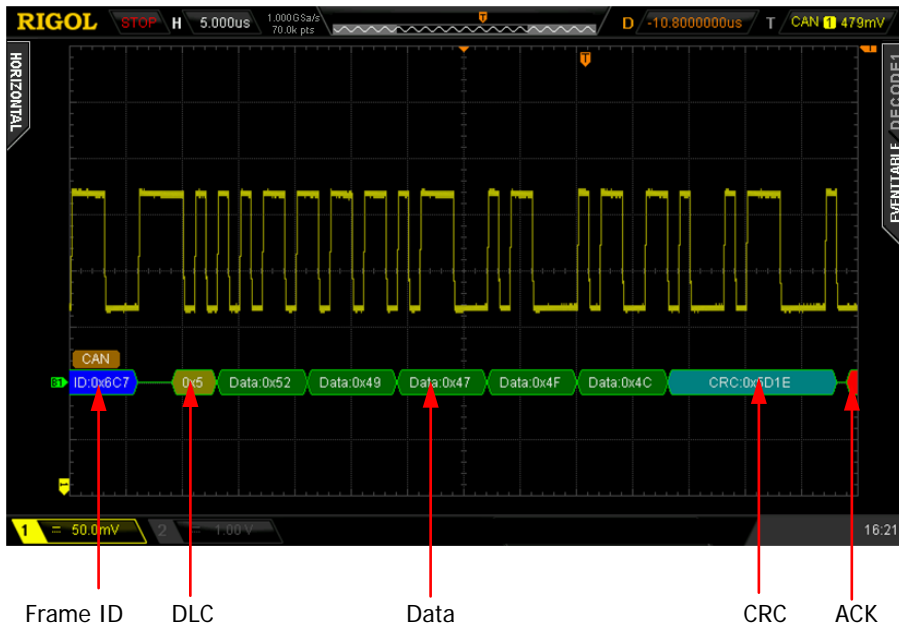

Figure 7-15 Decoded CAN Data Interpretation

## Chapter 8 Reference Waveform



The contents of this chapter:

- To Enable REF Function
- To Set the Color
- To Select REF Source
- To Save REF Waveform
- To Adjust REF Waveform Display
- To Export to Internal or External Memory
- To Import from Internal or External Memory

## To Enable REF Function

Press **REF** in the vertical control area (VERTICAL) on the front panel to enable the REF function.



**Note:** When the time base is in X-Y mode, REF function cannot be enabled.

DS2000E provides 10 reference waveform channels. Press **Channel**, rotate  to select the desired reference channel and press down  or **Channel** to turn the selected channel on or off. A channel icon (for example, ) of the channel enabled will be displayed at the left side of the screen grid.

When the REF function is enabled, you can select different color for each reference waveform, set the source of each reference channel, adjust the vertical scale and position of the reference waveform and save the reference waveform to internal or external memory as well as recall it when needed. For the details, please refer to the introductions below.

## To Set the Color

The DS2000E series oscilloscope provides five colors (light gray, green, light blue, magenta, and orange) to mark the reference waveforms of different channels in order to distinguish them.

Press **Current** and use  to select any of the reference channels (Ref1-Ref10) enabled. Then, press **Color** to specify a different color for the reference waveform of that channel. The corresponding icon at the left of the channel currently selected will be filled with the specified color, for example, .

## To Select REF Source

Press **Current** and use  to select any of the reference channels (Ref1 to Ref10) enabled and then press **Source** to specify a reference source (CH1, CH2, or MATH) for this channel. Only the currently enabled channels can be selected.





## To Save REF Waveform

After the REF source is selected, press **Save** to save the waveform (screen region) in the specified source to internal memory as reference waveform and display it on the screen.

**Note:** This operation only saves the reference waveform in the volatile memory and the waveform will be cleared at power-off.

## To Adjust REF Waveform Display

You can adjust the vertical scale and vertical position of the reference waveform specified in **Current**.

Press **Current**, use  to select any channel currently enabled (Ref1-Ref10). Press , use  to adjust the vertical position of the reference waveform. Press , use  to adjust the vertical scale of the reference waveform. Press **Reset** and the reference waveform returns to the position where the source channel waveform is located when the **Save** operation was executed.

## To Export to Internal or External Memory

Users can save the reference waveform in "\*.ref" format to the internal memory or external USB storage device. At most 10 reference files (LocalREF0.ref to LocalREF9.ref) can be saved inside the instrument.

Press **Export** to enter the file store interface. Please refer to the relative descriptions in "**Store and Recall**" to save the reference waveform to internal or external memory.

## To Import from Internal or External Memory

Users can also import the reference waveform stored in the internal memory or external USB storage device to the instrument.

Press **Import** to enter the file recall interface. Please refer to the relative descriptions in "**Store and Recall**" to import the reference waveform to the instrument.



## Chapter 9 Pass/Fail Test

During the product design and manufacturing process, you usually need to monitor the change of the signal or judge whether the product is up to standard. The pass/fail test function of the DS2000E oscilloscope can fulfill this task perfectly.

The contents of this chapter:

- To Enable Pass/Fail Test
- To Select Source
- Mask Range
- To Set Test Results Output Type
- To Save the Test Mask
- To Load the Test Mask

## To Enable Pass/Fail Test

Press **Utility** → **Pass/Fail** → **Enable** to select "ON". The area covered by blue on the screen denotes the failure area and if the waveform measured at certain time point during the measurement process passes through the failure area, it will be treated as failed frame. Press **Operate** to select "▶" to start testing and select "■" to stop testing.

**Note:** The pass/fail test function is not available in the following status.

- In X-Y time base mode;
- In ROLL time base mode;
- In Y-T time base mode and the horizontal time base is set to 200ms/div or slower, namely the instrument enters "Slow Sweep" mode;
- When the waveform record is enabled;
- None of the analog channels (CH1, CH2) is turned on.

After the pass/fail test is enabled, you can set the output type of the test results according to "**To Set Test Results Output Type**". You can also select the signal source, set the test mask range, create mask as well as save and recall the test mask. For the details, refer to the introductions below.

## To Select Source

Press **Source** to select the channel (CH1 or CH2) to be tested and only channels enabled can be selected.

## Mask Range

Users can define their desired test masks. If the waveform passes through the mask range (namely the waveform enters the area covered by blue), it is judged as a failed frame.

Press **Range** → **Range** to select "Screen" or "Cursor". The default is "Screen".

When "Screen" is selected, press **X Mask** and **Y Mask** respectively and rotate  to

adjust the horizontal tolerance range and vertical tolerance range of the test mask. The horizontal and vertical adjustment ranges are 0.02 div to 4 div and 0.04 div to 5.12 div respectively. During the adjustment, two white curves would be displayed in the interface to show the outline of the current mask. Press **Create** to apply the mask currently created (the area not covered by blue within the screen), as shown in the figure below.

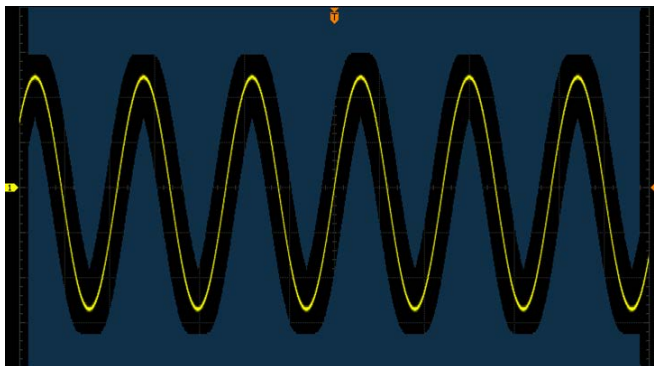



Figure 9-1 Test Mask (Screen Region)

When "Cursor" is selected, two gray cursor lines appear on the screen (used to indicate the current test mask range); cursor A is on the left and cursor B is on the right. Press **CursorA** and **CursorB** respectively and use  to adjust the positions of cursor A and cursor B. Or, press **CursorAB** and use  to adjust the positions of cursor A and cursor B at the same time (the horizontal distance keeps unchanged). Then, adjust the horizontal tolerance range and vertical tolerance range as well as create the mask (the area not covered by blue within the cursor region) by referring to the methods above; as shown in the figure below.

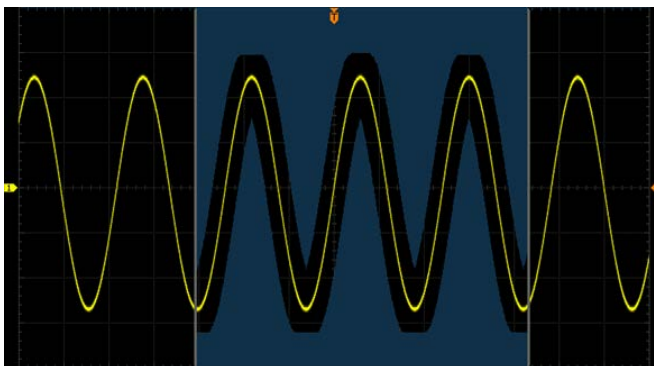

Figure 9-2 Test Mask (Cursor Region)

## To Set Test Results Output Type

You can set the output type of the test results referring to the following methods.

### 1. The Statistic Message

Press **Message** to select "ON" or "OFF". When "ON" is selected, the statistic message of the test results (including the number of the failed frames, the passed frames and the total frames) will be displayed at the upper right corner of the screen, as shown in the figure below.

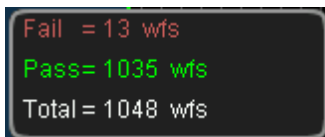

### 2. Stop on Fail

Press **StopOnFail** to select "ON" or "OFF".

- ON: when a failed waveform is detected, the oscilloscope will stop the test and enter the "STOP" state. At this point, the results of the test remain the same on the screen (if **Message** is set to "ON") and only one negative pulse is output from the **[Trigger Out]** connector (if **AuxOutput** is set to "ON") on the rear panel.
- OFF: the oscilloscope will continue with the test even though failed waveforms are detected. The test results on the screen will update continuously (if **Message** is set to "ON") and a pulse will be output from the **[Trigger Out]** connector (if **AuxOutput** is set to "ON") on the rear panel each time a failed waveform is detected.

### 3. Beeper on Fail

Press **Output** to select "Fail" or "Fail+".

- Fail: there is output when a failed waveform is detected; but, the beeper does not sound.
- Fail+: there is output when a failed waveform is detected and the beeper sounds (not related to the on/off state of the sound) at the same time.

### 4. [Trigger Out] Outputs Pulse When Failed

Press **AuxOutput** to select "ON" or "OFF". If "ON" is selected, the oscilloscope

outputs a pulse from the **[Trigger Out]** connector on the rear panel when a failed waveform is detected.

You can also press **Utility** → **AuxOutput** and select "PassFail" to set this output.

## To Save the Test Mask

Users can save the current test mask in "\*.pf" format to the internal memory or external USB storage device. The internal memory can store at most 10 test mask files (LocalPF.pf).

Press **Save** to enter the file store interface. Please refer to the relative descriptions in "**Store and Recall**" to save the test mask file to the internal or external memory.

## To Load the Test Mask

Users can also load the test mask files (\*.pf) stored in the internal memory or external USB storage device to the instrument.

Press **Load** to enter the file recall interface. Please refer to the relative descriptions in "**Store and Recall**" to load the test masks to the instrument.



## Chapter 10 Waveform Record

Waveform record can record the waveforms of the analog channels (CH1 and CH2). In record constant on (open) mode, the oscilloscope can record the input waveform continuously until users press **RUN/STOP**. Waveform playback and analysis can provide better waveform analysis effect.

**Note:** The horizontal time base must be set to Y-T mode during waveform recording.

The contents of this chapter:

- Waveform Record
- Record Constant On
- Waveform Playback
- Waveform Analysis

# Waveform Record





When the waveform record function is turned on, waveforms from all the channels currently turned on will be recorded. Press **Utility** → **Record** → **Mode** and use  to select "Record" to open the waveform record operation menu.

## 1. End Frame

Press **End Frame**; use  or the inner knob of the navigation knob to adjust the the desired number of frames to be recorded at a relatively smaller step or turn the outer knob of the navigation knob to adjust the the desired number of frames to be recorded at a relatively larger step. The available range is from 1 to the maximum number of frames that can be recorded currently (displayed in **Total Frames**).

## 2. Record Operation

Waveform record can be realized via the **menu** or the shortcut buttons on the front **panel**.

Menu	Front Panel
Press <b>Operate</b> and select "●" to start recording.	Press  ; the backlight goes on (in red) and starts to flash, indicating that the record is started.
When the record is finished, "●" changes to "■" automatically. You can also select "■" manually to stop recording.	When the record is finished,  goes off automatically and  goes on (in orange). You can also press  directly to stop recording.

## 3. Interval

Press **Interval**; use  or the inner knob of the navigation knob to adjust the time interval at a relatively smaller step or turn the outer knob of the navigation knob to adjust the time interval at a relatively larger step. The range available is from 100 ns to 10 s.

## 4. Total Frames

The menu shows the maximum number of frames that can be recorded currently.

The number of points of each frame is the current memory depth <sup>[1]</sup>. As the



capacity of the waveform memory is fixed, the more the number of points each frame of waveform has, the less the number of waveform frames can be recorded. Thus, the maximum end frame of waveform record is determined by the currently selected memory depth. Please refer to the instruction in "**Memory Depth**" to select the desired memory depth.

**Note**<sup>[1]</sup>: Memory depth = Sample rate × Horizontal time base × Number of grids horizontally on the screen. Wherein, for DS2000E, "Number of grids horizontally on the screen" is 14.



Therefore, when the memory depth is set to "Auto", the maximum number of end frames for waveform recording is also related to "Sample rate" and "Horizontal time base".

Table 10-1 Memory Depth and Maximum Number of Recorded Frames (In this example, only a single channel is turned on)

Memory Depth	Maximum End Frame
7 Kpts	8128
70 Kpts	508
700 Kpts	63
7 Mpts	7
28 Mpts	2
Auto	Related to the "Sample Rate" and "Horizontal Time Base"

## Record Constant On

DS2000E provides record "Open" (record constant on) mode for waveform recording. When this mode is enabled, the oscilloscope records the waveform continuously according to the current memory depth. The length of the waveform recorded is limited by the memory depth (sample rate and horizontal time base) and the waveform data recorded before will be overwritten by the waveform currently recorded. In this mode, the other oscilloscope operations (except "**Pass/Fail Test**", "**Protocol Decoding**" as well as "**Acquisition Mode**" and "**Memory Depth**" in the sample system setting and "**Time Base Mode**" in the horizontal system setting) are not affected.

Press **Utility** → **Record** → **Mode** and use  to select "Open". At this point, the waveform record key  on the front panel turns red and the oscilloscope records the waveform continuously according to the current memory depth. The oscilloscope stops recording until users press **RUN/STOP** and at this point, users can play back or analyze the waveform.

In constant on mode, the oscilloscope can capture the accidental abnormal signals during the adjustment. Following is an application example of the record constant on mode. Use DS2000E (CH1) to observe a pulse which might contain runt pulses.

1. Connect the pulse under test to CH1 of the oscilloscope. Adjust the oscilloscope to make it trigger stably.
2. Enable record constant on mode.

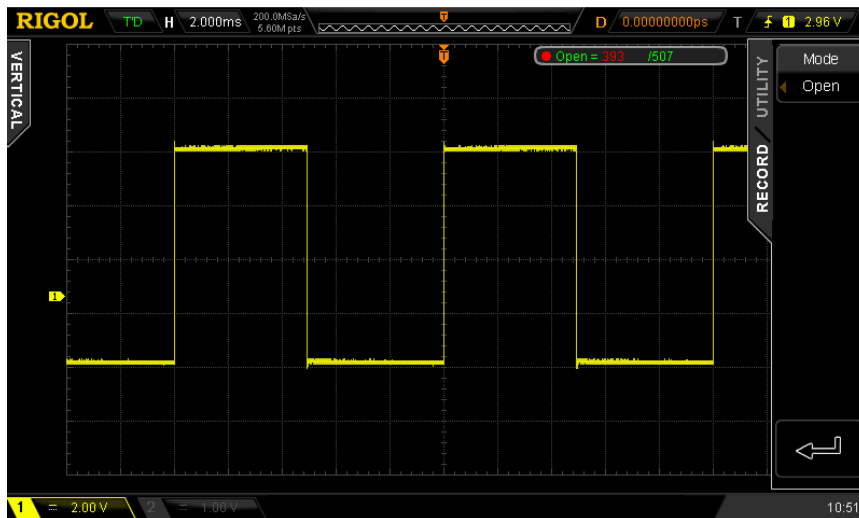

Figure 10-1 Record Constant On

3. Press **RUN/STOP** to stop the record.
4. Analyze the waveform recorded using waveform analysis and as shown in the figure below, the runt pulses are captured.

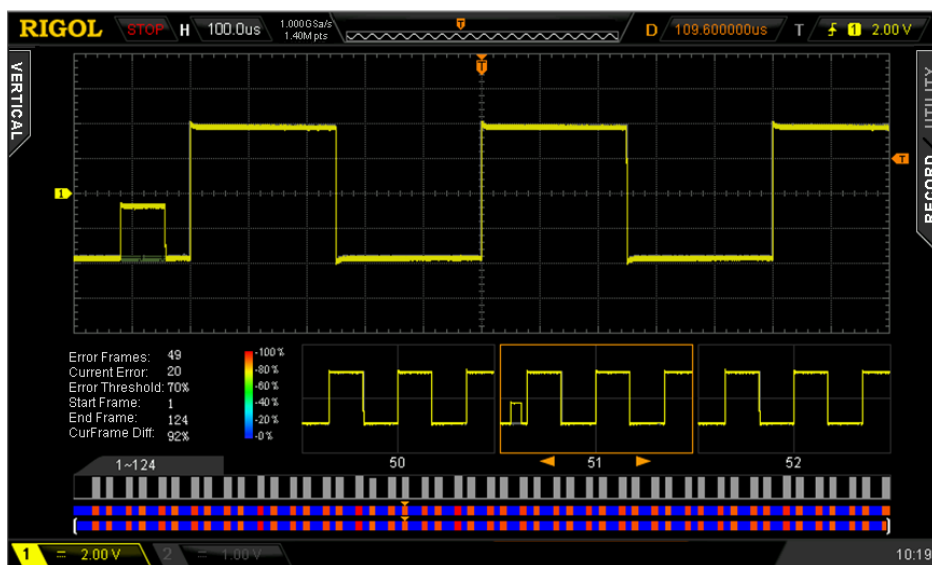



Figure 10-2 Analyze the waveform recorded

## Waveform Playback



Waveform playback can play back the waveforms currently recorded. After recording the waveforms, press **Utility** → **Record** → **Mode** and use  to select "Play back". At this point, the information as shown in the figure below is displayed at the upper right corner of the screen, indicating the specific frame currently displayed on the screen. During the playback, this value would change continuously.



Please refer to the following descriptions to set the playback parameters.

### 1. Play Mode

Press this softkey to set the playback mode to cycle or single.

- : cycle playback. Play from the start frame to the end frame and then repeat until you stop it manually.
- : single playback. Play from the start frame to the end frame and then stop.

### 2. Interval

Press this softkey and use  or the inner knob of the navigation knob to adjust the time interval of playback at a relatively smaller step or turn the outer knob of the navigation knob to adjust the time interval of playback at a relatively larger step. The range available is from 100 ns to 10 s and the default is 100 ns.

### 3. Start Frame

Press this softkey and use  to set the start frame of playback. The default is 1 and the maximum is the maximum number of frames recorded.

### 4. Current Frame

Press this softkey and set the current frame using  or the navigation knob by referring to the method mentioned above. By default, the current frame is the same with the end frame. The setting range of current frame is related to the start frame and end frame settings. During the setting, the screen will display the corresponding waveform of the current frame synchronously, namely manual playback.

If you perform the playback operation after setting this parameter, this menu will be adjusted to the start frame value automatically and will change continuously



during the playback process.

## 5. End Frame

Press this softkey and use  to set the end frame of the playback. The default is the total number of frames of the waveform recorded.

## 6. Playback Operation

Waveform playback can be realized through the menu or the shortcut buttons on the front panel.

Menu	Front Panel
Press <b>Operate</b> and select "▶" to start playing back.	Press  ; the backlight flashes, indicating that the playback is started.
Press <b>Operate</b> and select "  " to pause the playback.	Press  again (the backlight goes on (yellow)) to pause the playback.
Press <b>Operate</b> and select "■" to stop the playback.	Press  to stop the playback.

## 7. Time Tag

The time tag is used to display the absolute recording time of each frame of the waveform currently recorded. Press **Time Tag** to enable or disable the time tag function. When it is enabled, the time tag information is displayed at the upper right corner of the screen as shown in the figure below.

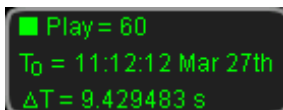

T<sub>0</sub>: display the absolute starting time of the waveform record.

ΔT: display the recording time deviation of the current waveform relative to the first frame of waveform. This value changes accordingly during the waveform playback process.

### Tip

During waveform playback, **RUN/STOP** can be used to switch between playback and pause. Each time **SINGLE** is pressed, the **Current Frame** moves one frame forward.

# Waveform Analysis

This function is used to analyze the recorded waveform. Press **Utility** → **Record** → **Mode** and use **↺** to select "Analyze" to open the waveform analysis menu. At this point, the screen is divided into two display areas as shown in the figure below.

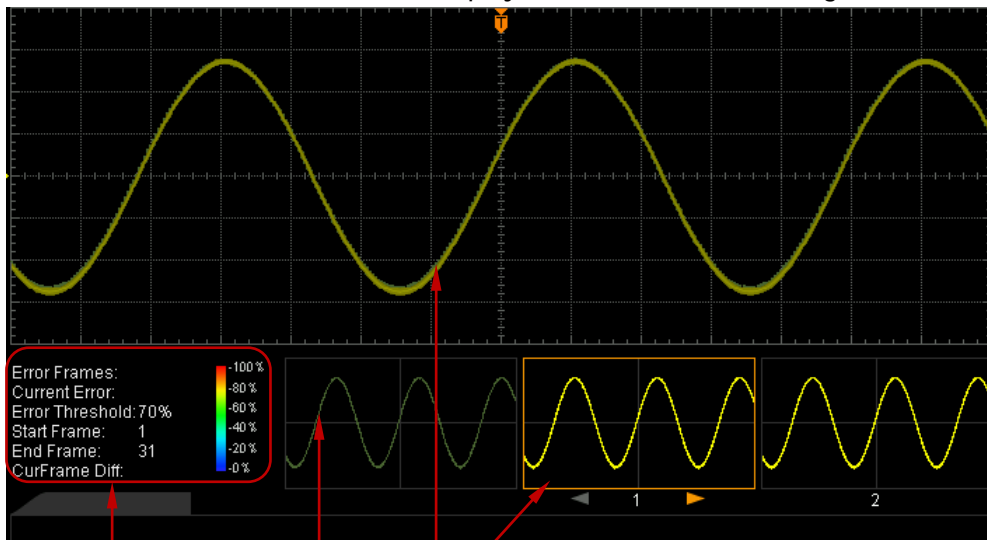

Settings and Results    Templet Display    Current Frame

Figure 10-3 Waveform Analysis

Please refer to the following explanations to set the waveform analysis parameters.

## 1. Analyze

Press **Analyze** to select the desired analysis mode.

- Trace: perform analysis on the basis of the templet selected by users. For the detailed information, refer to "**Analysis Based on Trace**".
- Pass/Fail: perform analysis on the basis of the Pass/Fail mask created by users. For the detailed information, refer to "**Analysis Based on Pass/Fail Mask**".

## 2. Source

Press **Source** to select the channel (CH1 or CH2) to be analyzed.

**Note:** Only currently enabled channels can be selected.

### 3. Start

Before performing the analysis, please set the templet by referring to "**Analysis Based on Trace**" or create the mask by referring to "**Analysis Based on Pass/Fail Mask**" according to the analysis mode currently selected. Then, press **Start** to enable waveform analysis.

**Note:** During the analysis process, the progress bar is displayed and the parameters cannot be modified.

After the analysis finishes, the analysis results of "Error Frames", "Current Error" and "CurFrame Diff" are displayed; at the same time, the first error frame is located as shown in the figure below. At this point, the next error frame, the previous error frame as well as every frame in this waveform analysis can be located using the corresponding softkeys.

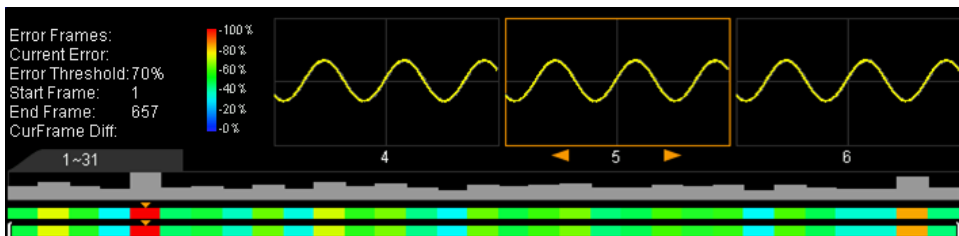

#### Error Frames:

The total number of error frames discovered in this analysis. The number of error frames is related to the error frame threshold currently set.

#### Current Error:

The order number of the error frame lately located in all the error frames when locating every data frame in this analysis.

#### CurFrame Diff:

During the analysis based on trace, the oscilloscope compares each frame with the templet to compute the difference value and normalizes each value using the maximum one; then, compares the normalized value of each frame with the threshold selected to judge whether the frame is an error frame. "CurFrame Diff" (relative difference) is the normalized value of the difference between the current frame and templet.

During the analysis based on pass/fail mask, the oscilloscope compares each frame with the mask to compute the difference value and recognizes the frame

whose difference value is equal to or larger than the threshold selected as an error frame and the corresponding "CurFrame Diff" is 100%; otherwise, the frame is judged as correct and the "CurFrame Diff" is 0%.

**Note:** There are only two "CurFrame Diff" values (100% and 0%) under the analysis based on pass/fail mask.

#### 4. Cancel

During the analysis, users can press **Cancel** to stop the analysis and press **Start** again to restart the analysis.

#### 5. Previous

After the waveform analysis finishes, pressing **Previous** can locate the error frame previous to the current error frame. Pressing **RUN/STOP** can also perform the operation.

#### 6. Next

After the waveform analysis finishes, pressing **Next** can locate the error frame following the current error frame. Pressing **SINGLE** can also perform the operation.

#### 7. Current Frame

Press **Current Frame**; use  or the inner knob of the navigation knob to adjust the data frame currently displayed at a relatively smaller step or turn the outer knob of the navigation knob to adjust the data frame currently displayed at a relatively larger step. The adjustable range is from 1 to the total number of frames in this waveform analysis.

#### 8. Setup

Press **Setup** to open the more detailed setting menu.

- Screen Start: press this key to set the start point of waveform analysis and the range is from 5 to 685. The start point must be less than the "Screen End - 10" currently set.
- Screen End: press this key to set the end point of waveform analysis and the range is from 15 to 695. The end point must be greater than the "Screen Start + 10" currently set.
- Start Frame: press this key to set the start frame of waveform analysis (refer to the setting method of the current frame mentioned above) and the



default is the first frame.

- End Frame: press this key to set the end frame of waveform analysis (refer to the setting method of the current frame mentioned above) and the default is the last frame.
- Threshold: press this key to set the threshold of waveform analysis and the range is from 1% to 99%. The threshold is used to judge whether the frame is an error frame. A frame is recognize as an error one if the (relative) difference value between the frame and the templet is equal to or larger than the threshold currently set.

## 9. Time Tag

The time tag is used to display the absolute recording time of each frame of the waveform currently recorded. Press **Time Tag** to enable or disable the time tag function. When it is enabled, the time tag information is displayed at the upper right corner of the screen as shown in the figure below.

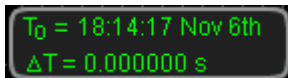

$T_0$ : display the absolute starting time of the waveform record.

$\Delta T$ : display the recording time deviation of the current waveform relative to the first frame of waveform.

## Analysis Based on Trace

Press **Analyze** and select "Trace". Then, set the templet used in analysis based on trace through the method below.

### 1. Trace

Press **Trace** to select the creation method of analysis templet.

- Current Frame: select the current frame as the analysis templet.
- Average: select the average of the current data frame as the analysis templet.

### 2. Setup Template

Press **Template** to configure the templet immediately. After the analysis starts, the oscilloscope compares each frame with the templet and determines whether error frame exists according to the threshold currently set.

### 3. TemplateDisp

Press **Template** to enable or disable templet display.

## Analysis Based on Pass/Fail Mask

Press **Analyze** and select "Pass/Fail". Then, set the templet used in analysis based on Pass/Fail mask through the method below.

Press **Range** to open the mask range setting menu. Please refer to the introduction in "**Mask Range**" to create the test mask used in waveform analysis.

Besides, you can store the current test mask in "\*.pf" format into the internal memory or external USB storage device or load the test mask file stored in the internal memory or external USB storage device into the instrument. Press **Save** to enter the file store interface. Store the test mask file to internal or external memory by referring to the introduction in "**Store and Recall**". Press **Load** to enter the file recall interface. Load the test mask into the instrument by referring to the introduction in "**Store and Recall**".



# Chapter 11 Display Control

You can set the type, persistence time and brightness of waveform display as well as the grid type, grid brightness of the screen display and the menu display time.

The contents of this chapter:

- To Select the Display Type
- To Set the Persistence Time
- To Set the Waveform Intensity
- To Set the Screen Grid
- To Set the Grid Brightness
- To Set the Menu Display

## To Select the Display Type

Press **Display** → **Type** to set the waveform display type to "Vectors" or "Dots".

- Vectors: the sample points are connected by lines and displayed, as shown in the left figure below. Normally, this mode can provide the most vivid waveform to view the steep edge of the waveform (such as square waveform).
- Dots: display the sample points directly, as shown in the right figure below. You can directly view each sample point and use the cursor to measure the X and Y values of the sample point.

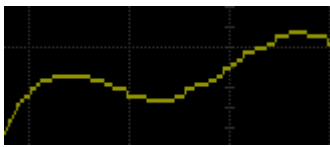

Vectors

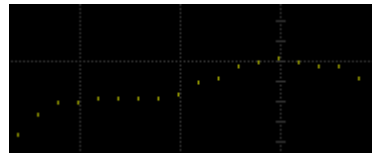

Dots

## To Set the Persistence Time

Press **Display** → **PersistTime** to set the persistence time of the oscilloscope to Min, specific values (from 50 ms to 20 s) or Infinite.

In the following part, a frequency sweep signal of the sine waveform is used to demonstrate the waveform effects in different persistence times.

### 1. Min

Enable to view waveform changing in high refresh rate.

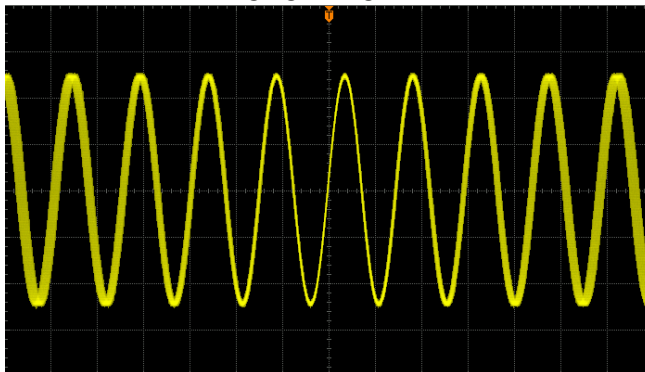

## 2. Specific Values

Enable to observe glitch that changes relatively slowly or glitch with low occurrence probability. The persistence time can be set to 50 ms, 100 ms, 200 ms, 500 ms, 1 s, 2 s, 5 s, 10 s or 20 s.

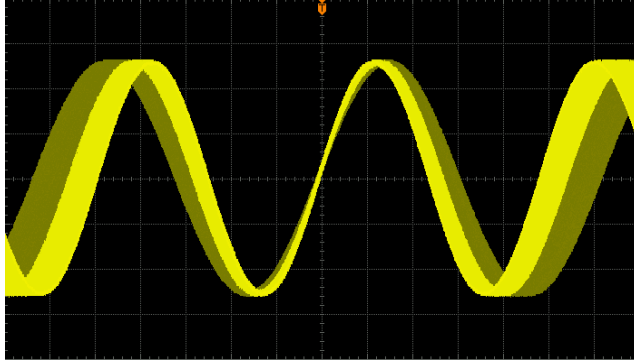

## 3. Infinite

In this mode, the oscilloscope displays the waveform newly acquired without clearing the waveforms acquired formerly. The waveforms acquired formerly will be displayed in relatively low-brightness color and the waveform newly acquired will be displayed in normal brightness and color. Infinite persistence can be used to measure noise and jitter and to capture incidental events.

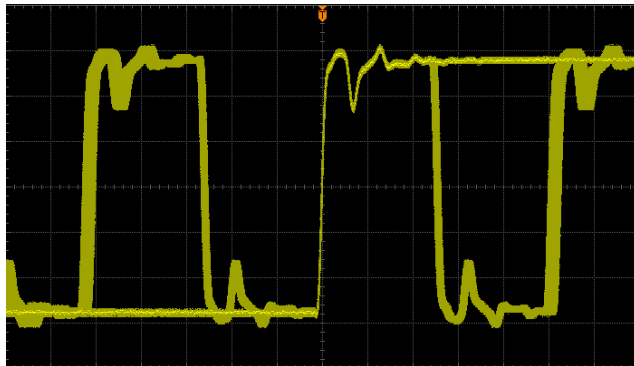



## To Set the Waveform Intensity

Press **Display** → **WaveIntensity** or turn  when the menu is hidden to adjust the waveform brightness of the analog channel. The default is 50% and the range available is from 0% to 100%.

## To Set the Screen Grid

Press **Display** → **Grid** to set the screen grid type.

- : turn the background grid and coordinate on.
- : turn the background grid off and coordinate on.
- : turn the background grid and coordinate off.

## To Set the Grid Brightness

Press **Display** → **Brightness** to set the brightness of the screen grid. Turn  to adjust the grid brightness. The default is 50% and the range available is from 0% to 100%.

## To Set the Menu Display

Press **Display** → **MenuDisplay** to set the menu display time. The menus displayed at both sides of the screen will hold for a specified period of time after the last button-pressing action and then is hidden. The display time can be set to 1 s, 2 s, 5 s, 10 s, 20 s or Infinite. If "Infinite" is selected, the menus will not be hidden.

**Note:** When storing a file or inputting a filename, the menus will not be hidden no matter whether the menu display time is set.



## Chapter 12 Store and Recall

Users can save the current settings, waveforms, screen image and parameters of the oscilloscope in internal memory or external USB mass storage device (such as USB storage device) in various file formats and recall the stored settings or waveforms when needed.

The contents of this chapter:

- Storage System
- Storage Type
- Internal Storage and Recall
- External Storage and Recall
- Disk Management
- Factory

# Storage System

Press **Storage** to enter the store and recall setting interface.

This oscilloscope provides a USB Host interface on the front panel to connect USB storage device for external storage. The USB storage device connected is marked as "Disk D". The internal memory (Local Disk) of the instrument can store 10 setting files, 10 reference waveform files and 10 mask files of the Pass/Fail test. Below is the disk management interface.



Figure 12-1 Disk Management Interface

Table 12-1 Icon Descriptions

Icon	Description	Icon	Description
	Return to the previous disk management interface		Waveform File
	Local Disk Memory		JPEG File
	External USB Storage Device		Pass/Fail Mask File
	Folder		PNG File
	Return to the previous folder		TIFF file
	Unknown File		Reference Waveform File
	Bitmap File		Setup File
	CSV File		Trace File

## Storage Type

Press **Storage** → **Storage** to select the desired storage type. The storage and recall descriptions of each type are as follows. If no USB storage device is connected to the instrument currently, only "Setups" is available.

### 1. Traces

Save the waveform data in external memory in "\*.trc" format. The data of all the channels turned on can be saved in the same file. At recall, the data will be displayed on the screen directly.

### 2. Waveforms

Save the waveform data in external memory in "\*.wfm" format. The stored files contain the waveform data of the two analog channels and the main setting information of the oscilloscope and all the data can be recalled.

### 3. Setups

Save the settings of the oscilloscope in internal or external memory in "\*.stp" format. At most 10 setting files (from LocalSetup0.stp to LocalSetup9.stp) can be stored in internal memory. The stored settings can be recalled.

### 4. Picture

Save the screen image in external memory in "\*.bmp", "\*.png", "\*.jpeg" or "\*.tiff" format. You can specify the file name and saving directory and save the corresponding parameter file (\*.txt) under the same directory using the same file name. The parameter file includes the current system information of the instrument (e.g. software and hardware version, time, and date) and other related setting information (e.g. vertical, scale, trigger, and channel on/off state). The recall of image and parameter files is not supported.

After selecting this type:

Press **Pic Type** to select the desired storage format.

Press **Para.Save** to enable or disable the parameter save function.

Press **Inverted** to enable or disable the invert function.

Press **Color** to set the color of the image. It can be set to "GrayScale" or "Color".

Press **Header** to enable or disable the header function. When it is enabled, the header would display the instrument information, such as the model, date and

time.

Press **Footer** to enable or disable the footer function. When it is enabled, the footer would display the serial number of the instrument.

**Tip**

After a USB storage device is connected, press  on the front panel to quickly save the current screen image under the root directory of the USB storage device.

## 5. CSV

Save the waveform data displayed on the screen or of the specified channels in external memory in a single "\*.csv" file. You can specify the file name and the saving directory and save the corresponding parameter file (\*.txt) under the same directory using the same file name. The recall of CSV and parameter files is not supported.

After selecting this type:

Press **DataDepth** to select "Displayed" or "Maximum". After selecting "Maximum", press **Channel** to select the desired channel (**Note:** Only currently enabled channels can be selected).

Press **Para.Save** to enable or disable the parameter save function.

Press **Sequence** to select whether to add sequence numbers for the waveform points in the CSV file. You can select "ON" or "OFF".

## Internal Storage and Recall

Internal storage and recall support "Setups" in **Storage**. In the following part, the storage and recall method and procedures are introduced.

### 1. Save the specified oscilloscope setting in internal memory.







- 1) Connect the signal to the oscilloscope and obtain stable display.
- 2) Press **Storage** → **Storage** to select "Setups" and press **Save** to turn on the disk management interface. Use  to select "Local Disk" (the characters turn green) and press down  to open the local disk, as shown in Figure 12-2.
- 3) The local disk can store at most 10 setting files. Use  to select the desired storage position, **Save** is illuminated and then press the softkey to execute the saving operation. If the current position contains a file, the original file can be overwritten or be deleted by pressing **Delete**. Use  to select  and then press down  to return to the previous directory.



Figure 12-2 Local Disk (Save)

**Note:** In internal storage, **New File** and **New Folder** are not available.

## 2. Load the specified type of file in internal memory.



- 1) Press **Storage** → **Storage** to select "Setups" and then press **Load** to turn on the disk management interface. Use  to select "Local Disk" and then press down  to open the local disk, as shown in Figure 12-3.
- 2) Use  to select the desired file to load and press **Load** to load the file selected.



Figure 12-3 Local Disk (Load)

## External Storage and Recall

Before using external storage and recall, make sure that the USB storage device is connected correctly. External storage supports all the types of files in **Storage** but in recall, "Picture" and "CSV" are not supported.

### 1. Save the specified type of file in the external USB storage device (take CSV as an example).



- 1) Connect the signal to the oscilloscope and obtain stable display.
- 2) Press **Storage** → **Storage** to select "CSV" and press **Save** to turn on the disk management interface. Use  to select "Disk D" and press down  to open the USB storage device, as shown in Figure 12-4.
- 3) Use  to select the desired storage position. The file can be stored under the root directory or in a certain folder under the root directory of the USB storage device.



Figure 12-4 External Disk (To Select the Storage Position)

- 4) After the storage position is selected, press **New File** to turn on the interface as shown in Figure 12-5. Refer to the descriptions in "**To Create a New File or Folder**" to create a new file.

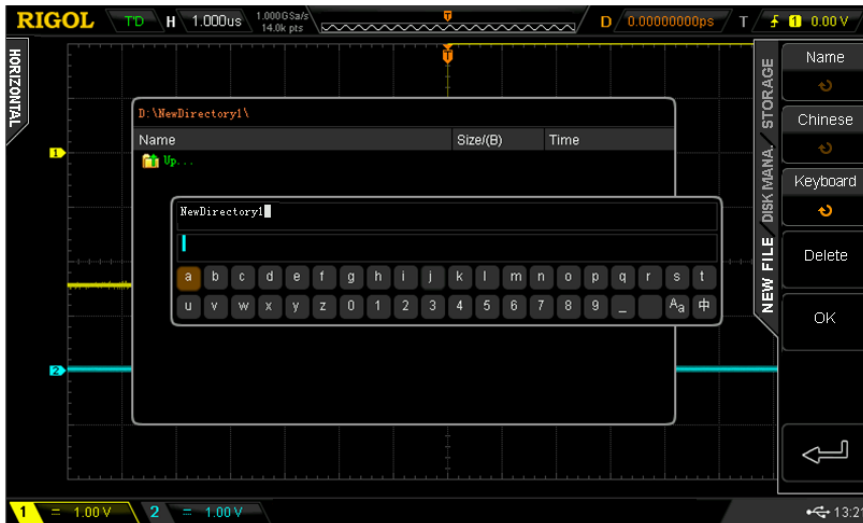

Figure 12-5 External Disk (To Create a New File)

5) Press **OK** to execute the saving operation.

**2. Load the specified type of file in the external USB storage device (take trace storage as an example).**



- 1) Press **Storage** → **Storage** to select "Traces" and then press **Load** to turn on the disk management interface. Use ↻ to select "Disk D" and press down ↻ to open the USB storage device, as shown in Figure 12-6.
- 2) Use ↻ to select the desired file to load and then press **Load** to load the selected file.



Figure 12-6 External Disk (To Select the File to Load)



## Disk Management

Press **Storage** → **Disk.Manage** to turn on the disk management interface as shown in Figure 12-1 and use  to select the desired disk. The disk currently selected is displayed in green and press down  to open the disk selected.

Execute the following operations through the disk management menu:

- To Select File Type
- To Create a New File or Folder
- To Delete a File or Folder
- To Rename a File or Folder
- To Clear the Local Memory

### To Select File Type

Except the file types in **Storage**, the oscilloscope can also display some files for advanced applications such as mask file of the Pass/Fail test (\*.pf), upgrade file (\*.gel), parameter file (\*.txt), and reference waveform file (\*.ref).

Press **Storage** → **Disk.Manage** → **File Type** to select the desired file type. The default is "\*.\*". Under the current directory, only files of which the suffix of the file name matches with the file type selected will be displayed in the current disk.

## To Create a New File or Folder

This operation is only valid in external storage. Before using external disk, make sure that the USB storage device is connected correctly.

First, press **Storage** → **Disk.Manage** and use  to select and open the external disk ("Disk D"). Then, select the desired directory under which to create a new file or folder. The default is the root directory of the USB storage device. Lastly, press **File Type** to select the desired file type and press **New File** or directly press **New Folder** to turn on the interface as shown in the figure below.

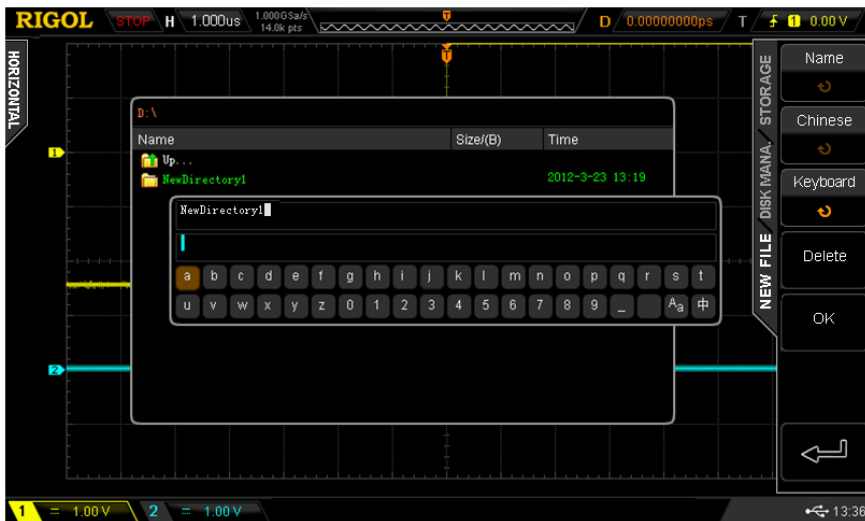



Figure 12-7 To Create a New File or Folder





This oscilloscope supports Chinese/English input method. The file name or folder name can contain letters, numbers, underscores, spaces, and Chinese characters. The length of the characters is limited to 10. The following part introduces how to input a file name or folder name using Chinese/English input method.

### Operation Tip

During the name input, use the menu softkeys to select different operation areas, then turn  to select the desired content and press down  to input the content selected.

## English Input Method

For example, create a file or folder with the name "Filename".

1. Press **Keyboard**.
  - 1) Use  to select English input method "En" and uppercase input state "A".
  - 2) Use  to input the letter "F". If the input is wrong, press **Delete** to delete the character input.
  - 3) Use  to select lowercase input state "a".
  - 4) Use  to input the remaining letters "ilename".

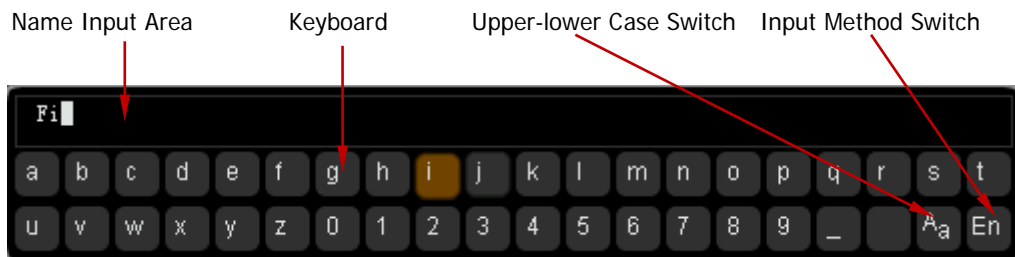



Figure 12-8 English Input Example

2. During the name input, you can press **Name** to select the "Name Input Area" and use  to move the cursor, then press **Delete** to delete the characters one by one.
3. After finishing the input, press **OK** and the oscilloscope will create a folder or a specified type of file with this name under the current directory.

## Chinese Input Method

For example, create a file or folder with the name "文件名".

1. Press **Keyboard**.
  - 1) Use  to select Chinese input method "中".
 



**Note:** **Chinese** is added in the menu items at the right of the screen.
  - 2) Use  to input the pinyin "wen". If the input is wrong, press **Delete** to delete the pinyin input. After "wen" is input, a series of Chinese characters appear in the "Chinese Character Selecting Area".
  - 3) Press **Chinese** and use  to select and input "文".
  - 4) Use the same method to input "件" and "名".





Figure 12-9 Chinese Input Example

2. During the name input, you can press **Name** to select the "Name Input Area" and then press **Delete** to delete the Chinese characters one by one.
3. After finishing the input, press **OK** and the oscilloscope will create a folder or a specified type of file with this name under the current directory.



## To Delete a File or Folder

Folder operation is valid only in external storage. Before using the external disk, make sure that the USB storage device is connected correctly.

1. Delete a file in internal memory.



- 1) Press **Storage** → **Disk.Manage** and use  to select and open the local disk ("Local Disk").
- 2) Press **File Type** to select the desired file type to be deleted (**Note:** The file types in the internal storage include "\*.stp", "\*.ref", and "\*.pf").
- 3) Use  to select the desired file to be deleted.
- 4) Press **Delete** → **OK** to delete the file selected.

2. Delete a file or folder in external memory.

Press **Storage** → **Disk.Manage** and use  to select and open the external disk ("Disk D"). Use  to select the file (or folder) to be deleted and then press **Delete** → **OK** to delete the selected file (or folder).

## To Rename a File or Folder

Rename operation is valid only in external storage. Before using the external disk, make sure that the USB storage device is connected correctly.

Press **Storage** → **Disk.Manage** and use  to select and open the external disk ("Disk D"). Use  to select the desired file or folder to rename and then press **Rename** to turn on the rename interface. For specific operations, please refer to the descriptions in "To Create a New File or Folder".

## To Clear the Local Memory

Press **Storage** → **Disk.Manage** and select "Local Disk"; then, turn to the next page of the menu and press **SecurityClear** → **OK** to delete all the files stored in the local memory.

**Note:** Don't press down  after selecting "Local Disk"; otherwise, **SecurityClear** will be grayed out and disabled.

## Factory

Press **Storage** → **Default** to return the oscilloscope to its factory state (refer to the table below).

Table 12-2 Factory

Parameter	Factory
Horizontal Setting (HORIZONTAL)	
Vertical Setting (VERTICAL)	
Acquisition Setting (Acquire)	
Trigger Setting (TRIGGER)	
Display Setting (Display)	
Cursor Setting (Cursor)	
Storage Setting (Storage)	
Utility Function Setting (Utility)	
Math Operation Setting (MATH->Operate)	
Protocol Decoding (Decode 1, Decode 2)	
Reference Waveform Setting (REF)	
<b>Horizontal Setting (HORIZONTAL)</b>	
Horizontal Time Base	1 $\mu$ s
Horizontal Offset	0 s
Delayed Sweep	OFF
Time Base Type	Y-T
Time Base Scale	Coarse
Horizontal Reference	The Center of the Screen
<b>Vertical Setting (VERTICAL)</b>	
Vertical Scale	1 V
Vertical Offset	0 V
CH1 Switch	ON
CH2 Switch	ON
Channel Coupling	DC
Bandwidth Limit	OFF
Probe Ratio	1X
Input Impedance	1 M $\Omega$

Channel Invert	OFF
Amplitude Scale	Coarse
Channel Unit	V
<b>Acquisition Setting (Acquire)</b>	
Acquisition Mode	Normal
Sampling Mode	Real Time
Memory Depth	Auto
Anti-Aliasing	OFF
<b>Trigger Setting (TRIGGER)</b>	
Trigger Level	0
Trigger Type	Edge
Source	CH1
Slope	Rising Edge
Trigger Mode	Auto
Trigger Coupling	DC
Trigger Holdoff	100 ns
Noise Reject	OFF
<b>Display Setting (Display)</b>	
Display Type	Vectors
Persistence Time	Min
Waveform Intensity	50%
Screen Grid	
Brightness	50%
Menu Display	Infinite
<b>Cursor Setting (Cursor)</b>	
Mode	OFF
<b>Manual</b>	
Display Mode	X-Y
Source	CH1
Screen Region	Main
Time Unit	s
Vertical Unit	Source Unit



<b>Horizontal Positions of X Cursors</b>	
CursorA	-4.000 $\mu$ s
CursorB	4.000 $\mu$ s
<b>Vertical Positions of Y Cursors</b>	
CursorA	0.000 V
CursorB	-4.000 V
<b>Track</b>	
Source of CursorA	CH1
Source of CursorB	CH1
<b>Horizontal Positions of X Cursors</b>	
CursorA	-4.000 $\mu$ s
CursorB	4.000 $\mu$ s
<b>Storage Setting (Storage)</b>	
Storage Type	Setups (when no USB storage device is connected) Picture (when a USB storage device is connected)
<b>Utility Function Setting (Utility)</b>	
<b>Sound</b>	
Sound	OFF
<b>Pass/Fail Test</b>	
Enable Test	OFF
Source	CH1
Operate	OFF
Mask Range	Screen
X Mask	0.24 div
Y Mask	0.48 div
Message Display	OFF
Stop On Fail	OFF
Output	Fail
AuxOutput	OFF
<b>Waveform Record</b>	
Mode	OFF
<b>Record</b>	
End Frame	4064
Operate	OFF

Interval	100 ns
Total Frames	4064
<b>Playback</b>	
Operate	Stop
Play Mode	Single
Interval	100 ns
Start Frame	1
Time Tag	OFF
<b>Analyze</b>	
Analysis Mode	Trace
Source	CH1
Trace Mode	Current Frame
Current Frame	1
Template Display	ON
Time Tag	OFF
<b>System Setting</b>	
Vertical Expansion	Ground
Screen Saver	Default
Screen Saver Time	OFF
AuxOutput	TrigOut
<b>Math Operation Setting (MATH-&gt;Operate)</b>	
Operate	OFF
<b>A+B</b>	
Source A	CH1
Source B	CH1
Invert	OFF
Vertical Scale	2 V
<b>A-B</b>	
Source A	CH1
Source B	CH1
Invert	OFF
Vertical Scale	2 V
<b>A×B</b>	
Source A	CH1
Source B	CH1

Vertical Invert	OFF
Scale	2 U
<b>A ÷ B</b>	
Source A	CH1
Source B	CH1
Invert	OFF
Vertical Scale	2 U
<b>FFT</b>	
Source	CH1
Window Function	Rectangle
Display	Split
Scale	dB
Vertical Scale	20 dBV
Horizontal Scale	1.25 MHz/div
Sample Rate	50 MSa/s
Anti-Aliasing	OFF
<b>Logic Operation</b>	
Log.Formula	AND
Source A	CH1
Source B	CH1
Invert	OFF
Vertical Scale	1 U
Threshold A	0 V
Threshold B	0 V
<b>Advanced Operation</b>	
Expression	OFF
Expression	CH1+CH2
Vertical Scale	2 V
Invert	OFF
<b>Protocol Decoding (Decode 1, Decode 2)</b>	
Decoding Type	Parallel
Bus Status	ON
Format	Hex
Offset	0
Threshold	0

<b>Parallel</b>	
Clock Channel	CH1
Slope	Rising Edge
Bus Bits	1
Current Bit	0
Channel	CH1
<b>RS232</b>	
TX	CH1
RX	None
Polarity	Normal
Endian	LSB
Baud	9600 bps
Data Bits	8
Stop Bit	1 bit
Even-Odd Check	None
Packet	OFF
Packet End	00 (NULL)
<b>I2C</b>	
SCLK	CH1
SDA	CH2
Include R/W	Close
<b>SPI</b>	
Decode Mode	TimeOut
TimeOut	1.00 $\mu$ s
SCLK Channel	CH1
SCLK Slope	Rising Edge
SDA Channel	CH2
SDA Polarity	1 for high level
Data Bits	8
Endian	MSB
<b>CAN</b>	
Source	CH1
Signal Type	Rx
Baud	500 kb/s
Sample Point	50.0%

<b>Reference Waveform Setting (REF)</b>	
Channel Setting	Ref1
Current Channel	Ref1
Source	CH1
Color	Gray



# Chapter 13 System Function Setting

The contents of this chapter:

- Remote Interface Configuration
- System-related

## Remote Interface Configuration

DS2000E can communicate with PC via LAN, USB, or GPIB (with the USB-GPIB interface converter provided by **RIGOL**) bus. Please refer to the introduction below to configure the corresponding interface before using the remote interfaces.

### LAN Setting

Press **Utility** → **IO Setting** → **LAN Set** to turn on the LAN setting interface. You can view the network connection status and configure the network parameters.

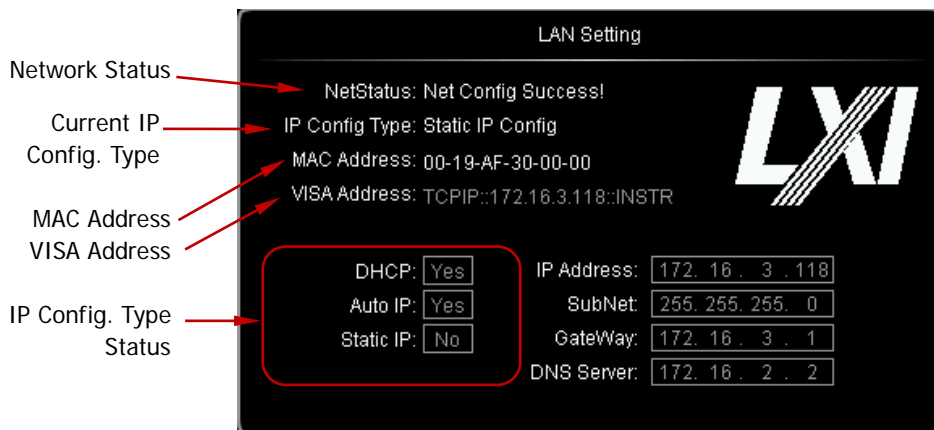

Figure 13-1 LAN Setting Interface

### Network Status

Connect the oscilloscope to your local area network using the network cable. The network interface of the oscilloscope is on the rear panel. The oscilloscope will give different prompts according to the current network connection status.



- Net Config Success!
- Acquire IP...
- IP Conflict!
- Unconnected!
- DHCP Fail!
- Read Status Fail!



## IP Configuration Type



The configuration type of the IP address can be DHCP, auto IP or static IP. In different IP configuration type, the configuration mode of the network parameters (such as the IP address) is different.

### DHCP

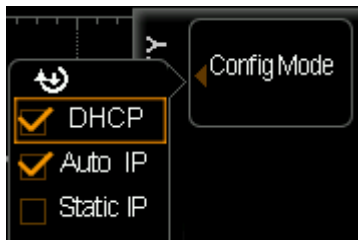

Press **Config Mode** and use  to select "DHCP". Then press down  to select this type. When DHCP type is valid, the DHCP server in the current network will assign the network parameters (such as the IP address) for the oscilloscope.



### Auto IP

Press **Config Mode** and use  to select "Auto IP". Then press down  to select this type. When the auto IP type is valid, disable DHCP manually, **Gate** and **DNS** are added to the right side of the screen and users can define the gateway and DNS server address of the oscilloscope. In auto IP mode, the oscilloscope will get the IP address ranging from 169.254.0.1 to 169.254.255.254 and the subnet mask 255.255.0.0 automatically according to the current network configuration.

### Static IP

Press **Config Mode** and use  to select "Static IP". Then press down  to select this type. When this type is valid, disable DHCP and auto IP manually, **IP Address**, **Mask**, **Gate** and **DNS** are added to the right of the screen. At this point, users can define their own network parameters (such as the IP address) of the oscilloscope.

## 1. Set the IP Address

The format of IP address is nnn.nnn.nnn.nnn; wherein, the range of the first **nnn** is from 1 to 223 (except 127) and the ranges of the other three **nnn** are from 0 to 255. You are recommended to ask your network administrator for an IP address available.

Press **IP Address** and use  to input the desired IP address. This setting will be saved in the non-volatile memory and if "**Power-off Recall**" is set to "Last" and "DHCP" and "Auto IP" are "Off" at the next power-on, the oscilloscope will load the preset IP address automatically.

## 2. Set the Subnet Mask

The format of the subnet mask is nnn.nnn.nnn.nnn; wherein, the ranges of the **nnn** are from 0 to 255. You are recommended to ask your network administrator for a subnet mask available.

Press **Mask** and use  to input the desired subnet mask. This setting will be saved in the non-volatile memory and if "**Power-off Recall**" is set to "Last" and "DHCP" and "Auto IP" are "Off" at the next power-on, the oscilloscope will load the preset subnet mask automatically.

## Set the Gate

You can set this parameter in Auto IP and Static IP mode.

The format of the gate is nnn.nnn.nnn.nnn; wherein, the range of the first **nnn** is from 1 to 223 (except 127) and the ranges of the other three **nnn** are from 0 to 255. You are recommended to ask your network administrator for a gate address available.

Press **Gate** and use  to input the desired gate address. This setting will be saved in the non-volatile memory and if "**Power-off Recall**" is set to "Last" and "DHCP" and "Auto IP" are "Off" at the next power-on, the oscilloscope will load the preset gate address automatically.

## Set the Domain Name Server

You can set this parameter in **Auto IP** and **Static IP** mode.

The address format of the domain name server is `nnn.nnn.nnn.nnn`; wherein, the range of the first **nnn** is from 1 to 223 (except 127) and the ranges of the other three **nnn** are from 0 to 255. You are recommended to ask your network administrator for an address available.

press **DNS** and use  to input the desired address. Generally, users do not need to set the DNS, therefore this parameter setting can be ignored.

### Tips

- When the three IP configuration types are all turned on, the priority of the parameter configuration from high to low is "DHCP", "Auto IP" and "Static IP".
- The three IP configuration types cannot be all turned off at the same time.

## Apply the Network Parameter Setting

Press **Apply** to validate the current network parameter setting.

## Initialize the Network Parameters

Press **Initialize** to return the network parameters to the default state.

## mDNS

Press **mDNS** to enable or disable the multicast Domain Name System (mDNS). This system is used to provide the function of DNS server for service discovery in a small network without a DNS server.

## MAC Address

For each oscilloscope, the MAC address is unique. When attributing IP address for the oscilloscope, the MAC address is usually used to identify the instrument.

## VISA Address

Display the VISA address currently used by the oscilloscope.

## USB Device

This oscilloscope can communicate with a PC or a PictBridge printer via the **USB Device** interface on the rear panel. You need to set the oscilloscope to make it match with different device types.

Press **Utility** → **IO Setting** → **USB Device** and use  to select the desired device type.

- Computer: in this type, the oscilloscope can communicate with the PC.
- PictBridge: in this type, the oscilloscope can communicate with the PictBridge printer.

## GPIB Address



When using the GPIB mode to control the oscilloscope, you need to extend a GPIB interface for the oscilloscope using the USB-GPIB interface converter (need to be ordered separately).

To set the GPIB address of this interface, press **Utility** → **IO Setting** → **GPIB** and use  to input the desired address. The default is 1 and the range is from 1 to 30.

## System-related



### Sound

When the sound is enabled, you can hear the sound of the beeper when you press a key or a menu softkey on the front panel or when the prompt message pops up.

Press **Utility** → **Sound** to select  (on) or  (off). The default is off. When the sound is turned on,  will be displayed at the lower right corner of the screen.

### Language

This oscilloscope supports menus in multiple languages as well as Chinese/English help information, prompt messages and interface display.

Press **Utility** → **Language** and use  to select the desired language. Then press down  to select the language.

## System Information

Press **Utility** → **System** → **System Info** to view the system information. The system information contains manufacturer, model, serial number, software version and hardware version.

## Power-off Recall

You can set the system configuration to be recalled when the oscilloscope is powered on again after power-off.

Press **Utility** → **System** → **Power On** to select "Last" or "Default".

- Last: return to the setting of the system at last power-off.
- Default: return to the factory setting of the system.

## System Time

The system time is displayed at the lower right corner of the screen in "hh:mm (hour:minute)" format. When printing or storing a waveform, the file output will contain this time information.

Press **Utility** → **System** → **System Time** → **System Time** to turn on the setting interface as follows.

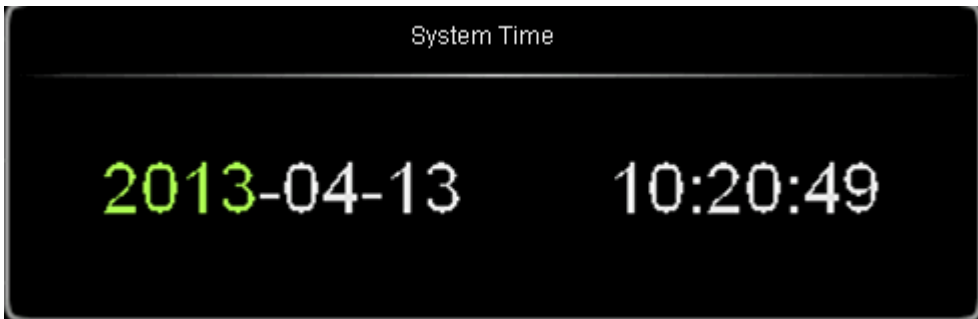



Figure 13-2 System Time Setting Interface

In the figure, the item in green (such as 2013) is the item that can be modified currently. Use  to modify and press down  to complete the input. The order of time modifications is: year (2013) → month (04) → date (13) → hour (10) → minute (20) → second (49). The setting range of each item conforms to the convention:

- Year: 2011 to 2099
- Month: 01-12
- Date: 01-31 (28, 29 or 30)
- Hour: 00 to 23
- Minute: 00 to 59
- Second: 00 to 59

Press **Apply** to put the current setting into effect. The time at the lower right corner of the screen will be updated.



## Screen

When the oscilloscope enters the idle state and holds for a certain period of time, the screen saver program will be enabled. By default, the screen saver program is off.

Press **Utility** → **System** → **Screen** to open the screen saver setting menu.

"Default" means using the icon **RIGOL** as the screen saver icon.

Press **Time** to select the screen saver time. When "OFF" is selected, the screen saver program is disabled. The screen saver time can be set to 1 min, 2 min, 5 min, 15 min, 30 min, 45 min, 60 min, 2 hour or 5 hour.

## Self-calibration

The self-calibration program can quickly make the oscilloscope reach the best working state to get the most precise measurement values. You can perform self-calibration at any time especially when the change of the environment temperature is up to or more than 5 °C. Make sure that the oscilloscope has been warmed up or operated for more than 30 minutes before the self-calibration.

Disconnect all the input channel connections, and then press **Utility** → **Self-Cal** to open the self-calibration menu and self-calibration interface.

Press **Start** and the oscilloscope will start to execute the self-calibration program.

Press **Exit** to give up the self-calibration operation at any time and return to the previous menu.

**Note:** Most of the keys are disabled during the self-calibration.

## Print Setting

PictBridge is a new print standard. If your oscilloscope and the printer both comply with the PictBridge standard, you can connect the oscilloscope to the printer using a USB cable to print the screen image directly. Devices comply with the PictBridge standard always have the icon as shown in the figure on the right side.



DS2000E digital oscilloscope supports PictBridge printer. Printers that support PictBridge can be connected directly via the USB Device interface on the rear panel of the oscilloscope. You can set the printer parameters using the oscilloscope to output the corresponding picture.

After connecting the printer, you need to first set the USB device type of the oscilloscope. Press **Utility** → **IO Setting** → **USB Device** to select "PictBridge". Then, press **Utility** → **Print** to set the print parameters.

### 1. Print

After setting the print parameters, press this key or press  on the front panel to execute the print operation.

### 2. Continue

When the print is paused, press this key to resume the unfinished print.

**Note:** This key is only available after the print is paused.

### 3. Abort

Pressing this key can stop the current print via the oscilloscope.

**Note:** This key is only available during the print process.

### 4. Status

Press this key and pop-up message box will be displayed on the screen showing the current print status.

### 5. Print Range

Press this key to set the print range to "Screen" or "Wave" and the default is "Screen".

- Screen: print the whole screen image.
- Wave: only print the waveform area.

## 6. Palette

Press this key to set the print color to "Gray Scale" or "Color" and the default is "Color".

## 7. Paper Size

Press this key to open the size list and rotate the multi-function knob  to select the desired paper size. You can also press this key continuously to switch among the options. The sizes include "Default", "A2", "A3", "A4", "A5", "A6" or "B5".

**Note:** The paper sizes available are related to the property of the printer connected. Sizes not supported by the printer cannot be selected.

## 8. File Type

Press this key to open the file type list and rotate the mul-tifunction knob  to select the desired file type. You can also press this key continuously to switch among the options. The file types include "Default", "Exif/Jpeg" or "Bmp".

**Note:** The file types available are related to the property of the printer connected. File types not supported by the printer cannot be selected.

## 9. Print Quality

Press this key to open the print quality list and rotate the mul-tifunction knob  to select the desired print quality. You can also press this key continuously to switch among the options. The print qualities include "Default", "Normal", "Draft" or "Fine".

**Note:** The print qualities available are related to the property of the printer connected. Print qualities not supported by the printer cannot be selected.

## 10. Date Print

Press this key to set the date print to "ON" or "OFF" and the default is "OFF".

**Note:** The date print is determined by the property of the printer connected. It cannot be selected if the printer does not support this function.

## 11. Copies

Press this key to set the number of copies to be printed. Rotate the multi-function knob  to select the desired number of copies. The range is from 1 to 999.

## 12. Invert

Press this key to set the print color invert to "ON" or "OFF" and the default is "OFF".

## Power Status

Connect the oscilloscope to AC power using a power cord and at this point, the oscilloscope is energized. The DS2000E oscilloscope allows users to set the power status of the oscilloscope after it is connected to power source. Press **Utility** → **PowerStatus** to set the power status to "Default" or "Open".

- Default: after the oscilloscope is energized, press the power key on the front panel to start the instrument.
- Open: the instrument starts directly when it is energized.

**Note:** At this point, you can still press the power key on the front panel to turn off the instrument.

## Aux Output

Users can set the type of the signal output from the **[Trigger Out]** connector on the rear panel.

Press **Utility** → **AuxOutput** to select the desired output type.

- **TrigOut**

After this type is selected, the oscilloscope outputs a signal that can reflect the current capture rate of the oscilloscope at each trigger. Connect this signal to a waveform display device, measure the signal frequency and the measurement result equals the current acquisition rate.

- **PassFail**

After this type is selected, the oscilloscope will output a pulse signal from the **[Trigger Out]** connector on the rear panel when failed waveforms are detected in the pass/fail test.

## Option Management

This oscilloscope provides multiple options to fulfill your measurement requirements. To use the option functions, please order the corresponding options according to the order numbers provided in "**Appendix A: Accessories and Options**" in this manual. You can view the options currently installed on the oscilloscope and activate the newly bought option.

### 1. View the installed options

Press **Utility** → **Options** → **Installed** to open the current option interface. You can view the options currently installed on the oscilloscope and the related information.

### 2. Install an option

To install an option, an option license (each instrument corresponds to a license) or option license file is required. Option license is a 28-byte string consisting of uppercase English letters and numbers. The option license file is a file that satisfies the specific format and the file extension is **.lic**.

After you purchase the desired option, you can get the corresponding key. Before installing an option, follow the steps below to generate the option license or option license file using the key according to your need.

- 1) Log in **RIGOL** official website ([www.rigol.com](http://www.rigol.com)); click **Service** → **Software License Register** to enter the software license registration interface.
- 2) In the software license registration interface, input the correct key, the instrument serial number (press **Utility** → **System** → **System Info** to acquire the instrument serial number) and the verification code. Press **Generate** to acquire the option license code and the download link of the option license file. To use the option license file, click **download** and download it to the root directory of the USB storage device.

### Use the option license

After acquiring the option license, press **Utility** → **Options** → **Setup** to open the option installation interface. In the interface, you can input the option license and install the option.

- 1) Press **Editor** to open the option license input interface as shown in the figure below.

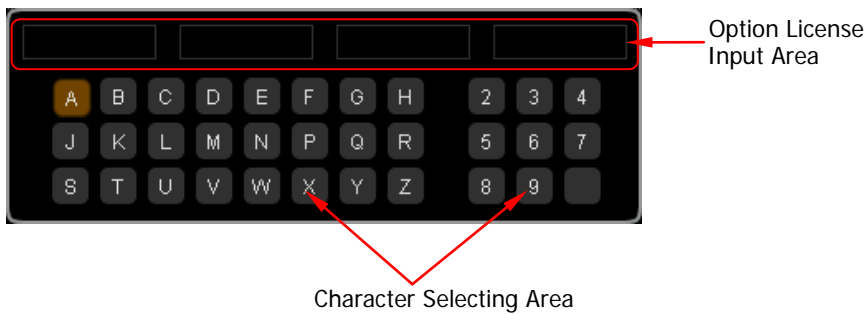

- 2) Input the option license.  
Turn  to select the specified character and press the knob to input the character in the "Option License Input Area". By default, the characters input are displayed in the area from left to right.

**Note:** The hyphens are not included in the option license.

During the input, you can press **Backspace** continuously to delete the characters in the "Option License Input Area" from right to left or press **Clear** to clear all the characters in the "Option License Input Area".

- 3) After inputting the option license correctly, press **Apply** and the oscilloscope will activate the corresponding option using the option license currently input.

In addition, you can also send SCPI commands to install the option. For the details, refer to *DS2000E Programming Guide*.

### Use the option license file

After acquiring the option license file, install the option following the steps below.

- 1) Confirm that the option license file is located in the root directory of the USB storage device; insert the USB storage device into the oscilloscope correctly.
- 2) At this point, the prompt message "License file detected, install?" is displayed. Press **License** to install the option and the installation progress is displayed. After the option is installed, the current option interface is displayed.



**Note:**

- A USB storage device can only store a single option license file of the same instrument; but can store the option license files of multiple different instruments.
- During the option installation process, do not power off the instrument or pull out the USB storage device.

## Auto Setting

You can set the channel coupling mode after performing AUTO operation (press **AUTO** to enable the waveform auto setting function).

Press **Utility** → **Auto Setup** → **Coupling** to select "Default", "DC" or "AC".



# Chapter 14 Remote Control

The DS2000E oscilloscope can be controlled remotely through the following two methods.

## User-defined programming

Users can program and control the oscilloscope by using the SCPI (Standard Commands for Programmable Instruments) commands. For more information about the commands and programming, refer to the *DS2000E Programming Guide*.

## Use PC software

Users can use the PC software to send commands to remotely control the oscilloscope. Ultra Sigma of **RIGOL** is recommended. You can download the latest version of the software from **RIGOL** official website ([www.rigol.com](http://www.rigol.com)).

This oscilloscope can communicate with PC through USB, LAN or GPIB (with the USB-GPIB interface converter provided by **RIGOL**) instrument bus. This chapter will give a detailed introduction of how to use Ultra Sigma to control DS2000E remotely through various interfaces.

The contents of this chapter:

- Remote Control via USB
- Remote Control via LAN
- Remote Control via GPIB

## Remote Control via USB

### 1. Connect the device

Use a USB cable to connect the oscilloscope with your PC via the USB Device interface.

### 2. Install the USB driver

This oscilloscope is a USB-TMC device. After you connect the oscilloscope to the PC and turn both on for the first time (the oscilloscope is automatically configured to USB interface; at the same time, make sure that **Utility** → **IO Setting** → **USB Device** is set to "Computer"), the **Found New Hardware Wizard** as shown in the figure below is displayed on the PC. Please install the "USB Test and Measurement Device (IVI)" driver following the directions in the wizard. The steps are as follows.

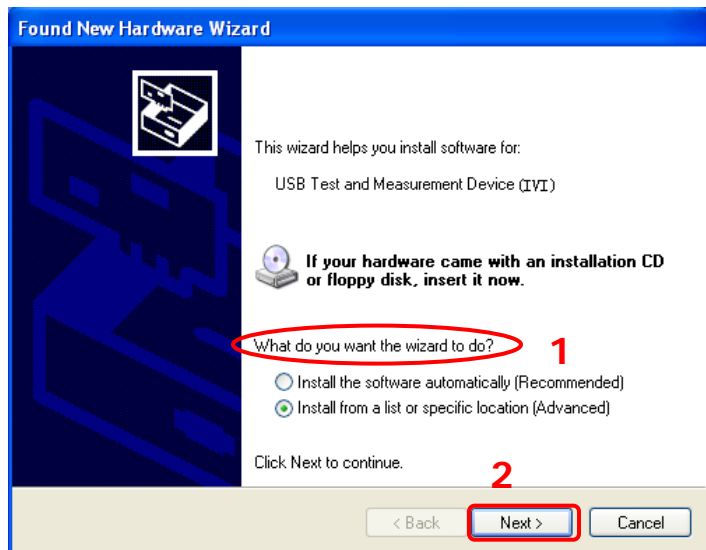

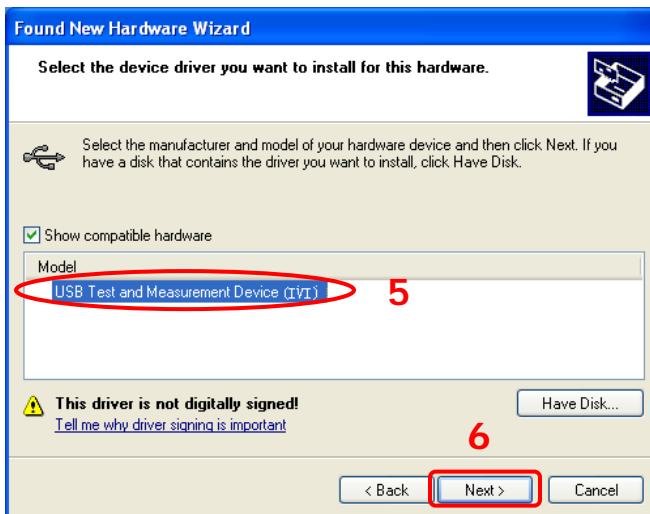
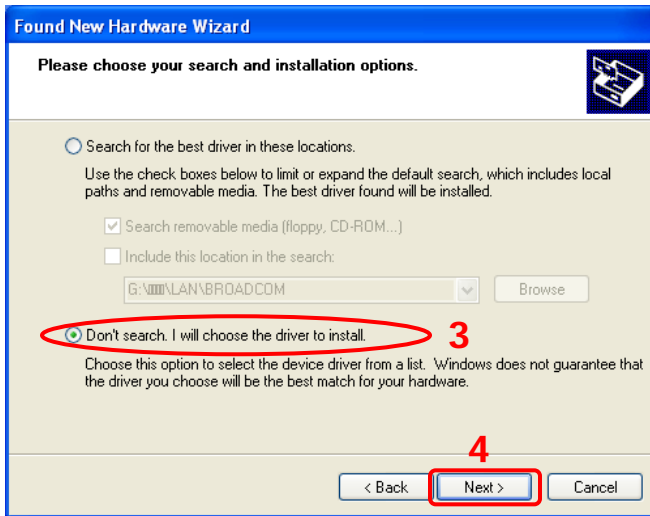

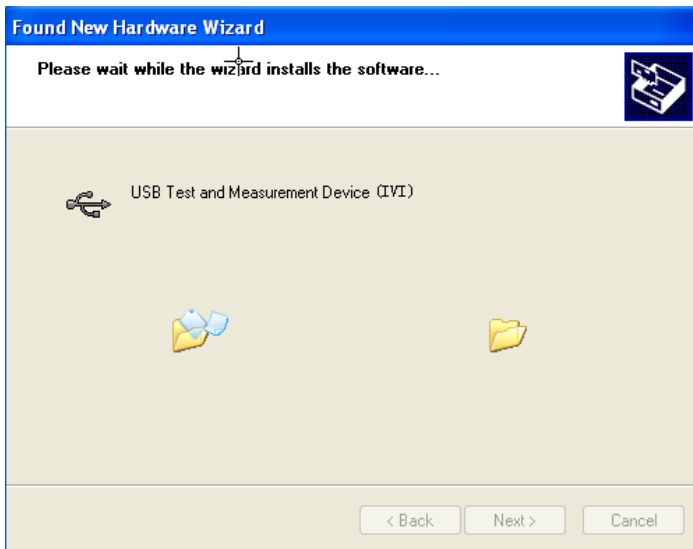

**3. Search for device resource**

Start up Ultra Sigma and the software will automatically search for the instrument resources currently connected to the PC via the USB interface. You can also click **USB-TMC** to search the resources.

**4. View the device resource**

The resources found will appear under the "RIGOL Online Resource" directory and the model number and USB interface information of the instrument will also

be displayed.

For example, DS2202E (USB0::0x1AB1::0x04B0::DS2A164750338::INSTR).

## 5. Control the instrument remotely

Right click the resource name

"DS2202E (USB0::0x1AB1::0x04B0::DS2A164750338::INSTR)" to select "SCPI Panel Control" to turn on the remote command control panel, through which you can send commands and read data.

## Remote Control via LAN

### 1. Connect the device

Connect the oscilloscope to your LAN using a network cable.

### 2. Configure network parameters

Configure the network parameters of the oscilloscope according to the description in "LAN Setting".

### 3. Search for device resource

Start the Ultra Sigma, click **LAN** and the panel as shown below is displayed. Click **Search** and the software will search for the instrument resources currently connected to the LAN; the resources found are displayed at the right of the panel. Click **OK** to add the resource.

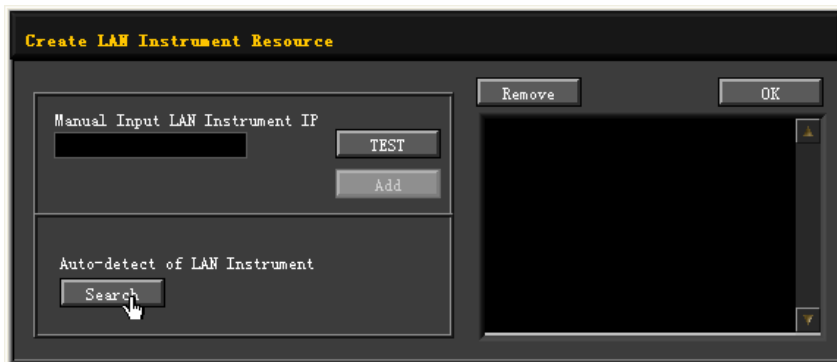

**Note:** If you want to remove the unwanted resource, click the corresponding resource name to select it and then click **Remove**.

### 4. View device resource

The resources found will appear under the "RIGOL Online Resource" directory. For example, DS2202E (TCPIP::172.16.3.83::INSTR).

### 5. Control the instrument remotely

Right click the resource name "DS2202E (TCPIP::172.16.3.83::INSTR)" to select "SCPI Panel Control" to turn on the remote command control panel through which you can send commands and read data.



## 6. Load LXI webpage

As this oscilloscope conforms to LXI Core 2011 Device class instrument standards, you can load LXI webpage through Ultra Sigma (right click the resource name and select "LXI-Web"). Various important information about the oscilloscope (including the model number, manufacturer, serial number, description, MAC address and IP address) will be displayed on the webpage.

In the LXI webpage, click "Network Settings" at the left side; then, input the initial password "111111" in the pop-up window (by default, the user name is empty) and click "OK" to view or modify the current network settings of the instrument. Besides, you can also click "Security" at the left side of the webpage to reset the password.

**Tip**

You can also load the LXI webpage by entering the IP address of the instrument in the address bar of the PC browser.

# Remote Control via GPIB

## 1. Connect the device

Use the USB to GPIB interface converter to extend a GPIB interface for the oscilloscope. Then connect the oscilloscope to your PC using a GPIB cable.

## 2. Install the driver of GPIB card

Install the driver of the GPIB card which has been connected to the PC correctly.

## 3. Set the GPIB address

Set the GPIB address of the oscilloscope according to the description in "GPIB Address".

## 4. Search for device resource

Start up Ultra Sigma and click **GPIB** to open the panel as shown in the figure below. Click **Search** and the software will search for the instrument resources currently connected to the PC via the GPIB interface. The instrument resources found will be displayed on the right side of the panel. Click **OK** to add the resource.

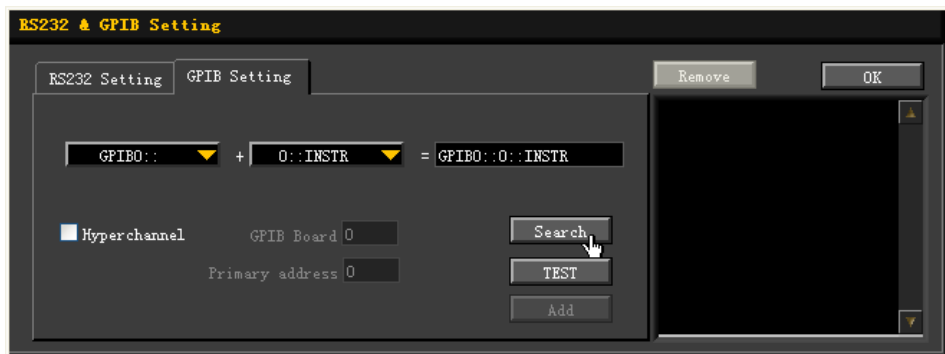

**Note:** If you want to remove the unwanted resource, click the corresponding resource name to select it and click **Remove**.

### If resources cannot be found automatically:

- Select the GPIB card address of the PC from the dropdown box of "GPIB0::" and select the GPIB address set in the oscilloscope from the dropdown box of "0::INSTR".

- Click **TEST** to check whether the GPIB communication works normally; if not, please follow the corresponding prompt messages to solve the problem.

#### 5. View device resource

The resources found will appear under the "RIGOL Online Resource" directory. For example, DS2202E (GPIB0::1::INSTR).

#### 6. Control the instrument remotely

Right click the resource name "DS2202E (GPIB0::1::INSTR)" and select "SCPI Panel Control" to turn on the remote command control panel, through which you can send commands and read data.



# Chapter 15 Troubleshooting

The commonly encountered failures and their solutions are listed below. When you encounter those problems, please solve them following the corresponding steps. If the problem remains still, please contact **RIGOL** and provide your device information (**Utility** → **System** → **System Info**).

## 1. The screen is still dark after pressing the power key:

- (1) Check whether the power switch is really on.
- (2) Check whether the power is correctly connected.
- (3) Check whether the fuse is burned out. If the fuse needs to be changed, please use the specified fuse.
- (4) Restart the instrument after finishing the above inspections.
- (5) If it still does not work correctly, please contact **RIGOL**.

## 2. The signal is sampled but no waveform of the signal is displayed:

- (1) Check whether the probe is correctly connected to the oscilloscope and item to be tested.
- (2) Check whether there are signals generated from the item to be tested (you can connect the probe compensation signal to the problematic channel to determine which has problem, the channel or the item to be tested).
- (3) Resample the signal.

## 3. The tested voltage amplitude is greater or lower than the actual value (this problem usually occurs when probe is used):

Check whether the probe ratio of the channel complies with the attenuation ratio of the probe.

## 4. There is waveform display but not stable:

- (1) Check the trigger source: press **MENU** → **Source** in the trigger control area (TRIGGER) on the front panel to check whether the trigger source selected complies with the signal channel actually used.
- (2) Check the trigger type: general signals should use "Edge" trigger and video signal should use "Video" trigger. Only when the proper trigger type is used, can the waveform be displayed stably.
- (3) Check the trigger level: adjust the trigger level to the middle of the signal.

- (4) Change the trigger coupling type: if edge trigger is currently selected, press **MENU** (in the trigger control area (TRIGGER) on the front panel) → **Setting** → **Coupling** to select "HF Reject" or "LF Reject" to filter out the high-frequency or low-frequency noise that disturbs the trigger.
- (5) Change the trigger holdoff setting.

#### 5. No display after pressing **RUN/STOP**:

Check whether the trigger mode in the trigger control area (TRIGGER) on the front panel is "Normal" or "Single" and whether the trigger level exceeds the waveform range. If yes, set the trigger level to the middle or set **MODE** to "Auto".

**Note:** Using **AUTO** could automatically finish the above setting.

#### 6. The display of waveform is ladder-like:

- (1) The horizontal time base might be too low. Increase the horizontal time base properly to improve the display.
- (2) If the display type is "Vectors", the lines between the sample points may cause ladder-like display. Press **Display** → **Type** to set the display type to "Dots" to solve the problem.

#### 7. Fail to connect a PC or a PictBridge printer through USB:

- (1) Press **Utility** → **IO Setting** → **USB Device** to check whether the current setting matches the device currently connected.
- (2) Check whether the USB cable is correctly connected to the oscilloscope.
- (3) Check whether the USB cable is in good condition. If needed, restart the oscilloscope.

#### 8. The USB storage device cannot be recognized:

- (1) Check whether the USB storage device can work normally.
- (2) Make sure that the USB storage device being used is flash storage type. This oscilloscope does not support hardware storage type.
- (3) Make sure whether the capacity of the USB storage device is too large. It is recommended that the capacity of the USB storage device being used with this oscilloscope is no larger than 8 GBytes.
- (4) Restart the instrument and then insert the USB storage device to check it.
- (5) If the USB storage device still cannot be used normally, please contact **RIGOL**.

## Chapter 16 Specifications

All the specifications are guaranteed except the parameters marked with "Typical" and the oscilloscope needs to operate for more than 30 minutes under the specified operation temperature.

### Sample

Sample Mode	Real-time Sampling
Real-time Sample Rate	1 GSa/s on both channels
Peak Detection	1 ns
Averaging	After all the channels have reached N times of sampling at the same time, N can be 2, 4, 8, 16, 32, 64, 128, 256, 512, 1024, 2048, 4096, or 8192.
High Resolution	12-bit resolution when $\geq 5 \mu\text{s}/\text{div}$ @ 1 GSa/s
Memory Depth	Auto, 7 kpts, 70 kpts, 700 kpts, 7 Mpts, and 28 Mpts

### Input

Number of Channels	2 analog channels
Input Coupling	DC, AC, or GND
Input Impedance	$(1 \text{ M}\Omega \pm 1\%)    (16 \text{ pF} \pm 3 \text{ pF})$ or $50 \Omega \pm 1.5\%$
Probe Attenuation Coefficient	0.01X-1000X, at 1-2-5 step
Maximum Input Voltage (1 M $\Omega$ )	CAT I 300 Vrms, CAT II 100 Vrms, Transient Overvoltage 1000 Vpk

### Horizontal

Timebase Scale	DS2102E: 5.000 ns/div to 1.000 ks/div DS2202E: 2.000 ns/div to 1.000 ks/div
Channel-to-Channel Skew	1 ns (typical), 2 ns (maximum)
Max Record Length	28 Mpts on both channels
Timebase Accuracy <sup>[1]</sup>	$\leq \pm 25 \text{ ppm}$
Clock Drift	$\leq \pm 5 \text{ ppm/year}$
Max. Delay Range	Negative delay: $\geq 1$ screen width Positive delay: 1 s to 100 ks

Time Base Mode	Y-T, X-Y, Roll
Number of X-Ys	1 path
Waveform Capture Rate <sup>[2]</sup>	50,000 wfms/s (dots display)

## Vertical

Bandwidth (-3 dB) (50 $\Omega$ )	DS2102E: DC to 100 MHz DS2202E: DC to 200 MHz
Single-shot Bandwidth (50 $\Omega$ )	DS2102E: DC to 100 MHz DS2202E: DC to 200 MHz
Vertical Resolution	8 bits
Vertical Scale <sup>[3]</sup>	When the input impedance is 50 $\Omega$ : 500 $\mu$ V/div to 1 V/div When the input impedance is 1 M $\Omega$ : 500 $\mu$ V/div to 10 V/div
Offset Range	When the input impedance is 50 $\Omega$ : 500 $\mu$ V /div to 50 mV/div: $\pm$ 2 V 51 mV/div to 200 mV/div: $\pm$ 10 V 205 mV/div to 1 V/div: $\pm$ 12 V When the input impedance is 1 M $\Omega$ : 500 $\mu$ V /div to 50 mV/div: $\pm$ 2 V 51 mV/div to 200 mV/div: $\pm$ 10 V 205 mV/div to 2 V/div: $\pm$ 50 V 2.05 V/div to 10 V/div: $\pm$ 100 V
Bandwidth Limit <sup>[1]</sup>	DS2102E: 20 MHz DS2202E: 20 MHz/100 MHz
Low Frequency Response (AC Coupling, -3 dB)	$\leq$ 5 Hz (on BNC)
Calculated Rise Time <sup>[1]</sup>	DS2102E: 3.5 ns DS2202E: 1.8 ns
DC Gain Accuracy <sup>[3]</sup>	$\pm$ 2% of full scale
DC Offset Accuracy	$\pm$ 0.1 div $\pm$ 2 mV $\pm$ 1% of offset value
Channel-to-Channel Isolation	DC to maximum bandwidth: >40 dB



**Trigger**

Trigger Level	Internal	$\pm 5$ div from the center of the screen
Range	EXT	$\pm 4$ V
Trigger Mode	Auto, Normal, Single	
Holdoff Range	100 ns to 10 s	
High Frequency Rejection <sup>[1]</sup>	75 kHz	
Low Frequency Rejection <sup>[1]</sup>	75 kHz	
Trigger Sensitivity	1 div (below 10 mV or noise rejection enabled) 0.3 div (above 10 mV and noise rejection disabled)	

**Edge Trigger**

Edge Type	Rising, Falling, Rising/Falling
-----------	---------------------------------

**Pulse Trigger**

Pulse Condition	Positive Pulse Width (greater than, smaller than, within a specific range) Negative Pulse Width (greater than, smaller than, within a specific range)
Pulse Width	2 ns to 4 s

**Runt Trigger**

Pulse Condition	None, >, <, <>
Pulse Polarity	Positive, Negative
Pulse Width Range	2 ns to 4 s

**Windows Trigger (Optional)**

Windows Type	Rising, Falling, Rising/Falling
Trigger Position	Enter, Exit, Time
Windows Time	16 ns to 4 s

**Nth Edge Trigger (Optional)**

Edge Type	Rising, Falling
Idle Time	16 ns to 4 s
Number of Edges	1 to 65,535

**Slope Trigger**

Slope Condition	Positive Slope (greater than, smaller than, within a specific range) Negative Slope (greater than, smaller than, within a specific range)
-----------------	--

	range)
Time Setting	10 ns to 1 s
<b>Video Trigger</b>	
Polarity	Positive, Negative
Synchrony	All Lines, Line Num, Odd Field, Even Field
Standard	Standard: NTSC, PAL/SECAM, 480P, 576P Optional: 720P, 1080P, 1080I
<b>Pattern Trigger</b>	
Pattern Setting	H, L, X, Rising Edge, Falling Edge
<b>Delay Trigger (Optional)</b>	
Edge Type	Rising, Falling
Delay Type	>, <, <>, ><
Delay Time	2 ns to 4 s
<b>TimeOut Trigger (Optional)</b>	
Edge Type	Rising, Falling, Rising/Falling
Timeout time	16 ns to 4 s
<b>Duration Trigger (Optional)</b>	
Pattern Setting	H, L, X
Trigger Criteria	>, <, <>
Duration Time	2 ns to 4 s
<b>Setup/Hold Trigger</b>	
Edge Type	Rising, Falling
Data Type	H, L
Setup Time	2 ns to 1 s
Hold Time	2 ns to 1 s
<b>RS232/UART Trigger</b>	
Polarity	Normal, Invert
Trigger Condition	Start, Error, Check Error, Data
Baud Rate	2400 bps, 4800 bps, 9600 bps, 19200 bps, 38400 bps, 57600 bps, 115200 bps, 230400 bps, 460800 bps, 921600 bps, 1 Mbps, and User
Data Bits	5 bits, 6 bits, 7 bits, 8 bits
<b>I2C Trigger</b>	
Trigger Condition	Start, Restart, Stop, Missing ACK, Address, Data, A&D
Address Bits	7 bits, 8 bits, 10 bits
Address Range	0 to 127, 0 to 255, 0 to 1,023

Byte Length	1 to 5
<b>SPI Trigger</b>	
Trigger Condition	Timeout
Timeout Value	100 ns to 1 s
Data Bits	4 bits to 32 bits
Data Setting	H, L, X
<b>CAN Trigger (Optional)</b>	
Signal Type	Rx, Tx, CAN_H, CAN_L, Differential
Trigger Condition	SOF, EOF, Frame Type, Frame Error
Signal Rate	10 kbps, 20 kbps, 33.3 kbps, 50 kbps, 62.5 kbps, 83.3 kbps, 100 kbps, 125 kbps, 250 kbps, 500 kbps, 800 kbps, 1 Mbps, User
Sample Points	5% to 95%
Frame Type	Data, Remote, Error, OverLoad
Error Type	Bit Fill, Answer Error, Check Error, Format Error, Random Error
<b>USB Trigger (Optional)</b>	
Signal Speed	Low Speed, Full Speed
Trigger Condition	SOP, EOP, RC, Suspend, Exit Suspend

## Measure

Cursor	Manual Mode	Voltage Deviation between Cursors ( $\Delta V$ ) Time Deviation between Cursors ( $\Delta T$ ) Reciprocal of $\Delta T$ (Hz) ( $1/\Delta T$ )
	Track Mode	Voltage and Time Values of the Waveform Point
	Auto Mode	Allow to display cursors during auto measurement
Auto Measurement	Maximum, Minimum, Peak-Peak Value, Top Value, Bottom Value, Amplitude, Average, Vrms-N, Vrms-1, Overshoot, Pre-shoot, Area, Period Area, Frequency, Period, Rise Time, Fall Time, Positive Pulse Width, Negative Pulse Width, Positive Duty Cycle, Negative Duty Cycle, Delay $A_f \rightarrow B_f$ , Delay $A_t \rightarrow B_t$ , Delay $A_f \rightarrow B_t$ , Delay $A_t \rightarrow B_f$ , Phase $A_f \rightarrow B_f$ , Phase $A_t \rightarrow B_t$ , Phase $A_f \rightarrow B_t$ , Phase $A_t \rightarrow B_f$	
Number of Measurements	Display 5 measurements at the same time	

Measurement Range	Screen region or cursor region
Measurement Statistics	Current, Average, Max, Min, Standard Deviation, Number of Measurements
Frequency Counter	Hardware 6-bit frequency counter (channels are selectable)

## Math Operation

Waveform Operation	A+B, A-B, A×B, A÷B, FFT, Digital Filter, Editable Advanced Operation, Logic Operation
FFT Window Function	Rectangle, Hanning, Blackman, Hamming
FFT Display	Split, Full Screen
FFT Vertical Scale	Vrms, dB
Logic Operation	AND, OR, NOT, XOR
Math Function	Intg, Diff, Log, Exp, Sqrt, Sine, Cosine, Tangent
Number of Buses for Decoding	2
Decoding Type	Parallel (standard), RS232/UART (optional), I2C (optional), SPI (optional), CAN (optional)

## Display

Display Type	8.0-inch (203 mm) TFT LCD
Display Resolution	800 Horizontal ×RGB×480 Vertical Pixel
Display Color	160,000 Color (TFT)
Persistence Time	Min, 50ms, 100ms, 200ms, 500ms, 1 s, 2 s, 5 s, 10 s, 20 s, Infinite
Display Type	Dots, Vectors
Real-time Clock	Time and Date (adjustable for users)

## I/O

Standard Ports	USB HOST (USB-GPIB supported), USB Device, LAN, Aux Output (TrigOut/PassFail)
----------------	---

## General Specifications

<b>Probe Compensation Output</b>		
Output Voltage <sup>[1]</sup>	About 3 V, peak-peak	
Frequency <sup>[1]</sup>	1 kHz	
<b>Power</b>		
Power Voltage	100 V to 240 V, 45 Hz to 440 Hz	
Power	Maximum 50 W	
Fuse	2 A, T Degree, 250 V	
<b>Environment</b>		
Temperature Range	Operating: 0°C to +50°C	
	Non-operating: -40°C to +70°C	
Cooling Method	Fan cooled	
Humidity Range	0°C to +30°C: ≤95%RH	
	+30°C to +40°C: ≤75%RH	
	+40°C to +50°C: ≤45%RH	
Altitude	Operating: under 3,000 m	
	Non-operating: under 15,000 m	
<b>Physical Characteristics</b>		
Dimensions <sup>[4]</sup>	Width×Height×Depth=361.6 mm×179.6 mm×130.8 mm	
Weight <sup>[5]</sup>	Package Excluded	3.9 kg ± 0.2 kg
	Package Included	4.5 kg ± 0.5 kg
<b>Calibration Interval</b>		
The recommended calibration interval is 18 months.		
<b>Electromagnetic Compatibility and Safety</b>		
EMC	complies with EMC Directive 2014/30/EU, complies with or above the standard specified in IEC61326-1:2013/EN61326-1:2013 Group 1 Class A	
	CISPR 11/EN 55011	
	IEC 61000-4-2:2008/EN 61000-4-2	±4.0 kV (contact discharge), ±8.0 kV (air discharge)
	IEC 61000-4-3:2002/EN 61000-4-3	3 V/m (80 MHz to 1 GHz); 3 V/m (1.4 GHz to 2 GHz); 1 V/m (2.0 GHz to 2.7 GHz)

	IEC 61000-4-4:2004/EN 61000-4-4	1 kV power
	IEC 61000-4-5:2001/EN 61000-4-5	0.5 kV (phase-to-neutral voltage); 1 kV (phase-to-earth voltage); 1 kV (neutral-to-earth voltage)
	IEC 61000-4-6:2003/EN 61000-4-6	3 V, 0.15 to 80 MHz
	IEC 61000-4-11:2004/EN 61000-4-11	voltage dip: 0% UT during half cycle; 0% UT during 1 cycle; 70% UT during 25 cycles short interruption: 0% UT during 250 cycles
Safety	complies with IEC 61010-1:2010 (Third Edition)/EN 61010-1:2010, UL 61010-1:2012 R4.16 and CAN/CSA-C22.2 No. 61010-1-12+ GI1+ GI2	

**Note**<sup>[1]</sup>: Typical.

**Note**<sup>[2]</sup>: Maximum value. 10 ns, dots display, auto memory depth.

**Note**<sup>[3]</sup>: 500 $\mu$ V /div is a magnification of 1 mV/div. When calculating the DC Gain Accuracy, the full scale should be considered as 8 mV (calculated based on 1 mV/div).

**Note**<sup>[4]</sup>: Supporting legs and handle folded, knob height included.

**Note**<sup>[5]</sup>: Standard configuration.

# Chapter 17 Appendix

## Appendix A: Accessories and Options

	Description	Order No.
<b>Model</b>	DS2102E (100 MHz, 2 analog channels)	DS2102E
	DS2202E (200 MHz, 2 analog channels)	DS2202E
<b>Standard Accessories</b>	Power Cord conforming to the standard of the destination country	-
	USB Cable	CB-USBA-USBB-FF-150
	2 Passive Probes (BW: 350 MHz)	PVP2350
	Quick Guide (hard copy)	-
<b>Optional Accessories</b>	Rack Mount Kit	RM-DS2000A
	Passive Probe (500 MHz)	RP3500A
	USB-GPIB Interface Converter	USB-GPIB
	A Portable Bag	BAG-G1
<b>High Memory Depth Option</b>	28 Mpts/CH memory (offering the official option for free)	-
<b>Advanced Trigger Option</b>	Windows Trigger, Nth Edge Trigger, Delay Trigger, TimeOut Trigger, Duration Trigger, USB Trigger	AT-DS2000A
<b>Decoding Options</b>	RS232/UART, I2C, SPI Decoding Kit	SD-DS2000A
	CAN Protocol Analysis Kit (Trigger + Decoding)	CAN-DS2000A
<b>Bundle Option</b>	Include all the advanced trigger options and decoding options	BND-DS2000A

**Note:** All the options or accessories can be ordered from you local **RIGOL** Office.

## Appendix B: Warranty

**RIGOL** TECHNOLOGIES, INC. (hereinafter referred to as **RIGOL**) warrants that the product will be free from defects in materials and workmanship within the warranty period. If a product proves defective within the warranty period, **RIGOL** guarantees free replacement or repair for the defective product.

To get repair service, please contact with your nearest **RIGOL** sales or service office.

There is no other warranty, expressed or implied, except such as is expressly set forth herein or other applicable warranty card. There is no implied warranty of merchantability or fitness for a particular purpose. Under no circumstances shall **RIGOL** be liable for any consequential, indirect, ensuing, or special damages for any breach of warranty in any case.



# Index

- Duty .....	6-17	Factory .....	12-15
- Width .....	6-17	Fall Time .....	6-17
+ Duty .....	6-17	FFT .....	6-4
+ Width .....	6-17	Frequency .....	6-17
Acquisition Mode .....	4-2	Frequency Counter .....	6-22
AND .....	6-9	Gate .....	13-4
Antialiasing .....	4-9	GPIO Address .....	13-7
Area .....	6-21	Hamming .....	6-5
Auto IP .....	13-3	Hanning .....	6-5
Auto Mode .....	6-36	High Resolution .....	4-4
Auto Setting .....	13-19	Horizontal Reference .....	3-9
Aux Output .....	13-16	Horizontal Scale .....	3-8
Average .....	4-2	I2C Decoding .....	7-10
Bandwidth Limit .....	2-3	I2C Trigger .....	5-37
Blackman .....	6-5	Idle Time .....	5-18
CAN Decoding .....	7-16	Input Impedance .....	2-5
CAN Trigger .....	5-45	IP Address .....	13-4
Channel Coupling .....	2-3	MAC .....	13-6
Channel Label .....	2-7	Manual Mode .....	6-30
CSV .....	12-4	mDNS .....	13-5
Cursor .....	6-29	Memory Depth .....	4-8
Delay .....	6-18	Network Status .....	13-2
Delay Calibration .....	2-9	Noise rejection .....	5-6
Delay Trigger .....	5-27	Normal .....	4-2
Delayed Sweep .....	3-2	NOT .....	6-9
DHCP .....	13-3	Nth Edge Trigger .....	5-17
Digital Filter .....	6-7	Operator .....	6-12
Domain Name Server .....	13-5	Option Management .....	13-17
Dots .....	11-2	OR .....	6-9
Duration Trigger .....	5-32	Overshoot .....	6-21
Edge Trigger .....	5-8	Parallel Decoding .....	7-2
Edge Type .....	5-8, 5-17	Pass/Fail Test .....	9-1
Event Table .....	7-3	Pattern Setting .....	5-25, 5-32
Expression .....	6-11	Pattern Trigger .....	5-25

Peak Detect .....	4-4	Trigger Level.....	5-9
Period .....	6-17	Trigger Mode .....	5-3
Period Area .....	6-21	Trigger Position .....	5-15
Persistence Time .....	11-2	Trigger Source .....	5-2
Phase .....	6-18	USB .....	13-7
Picture.....	12-3	USB Trigger .....	5-43
Preshoot.....	6-21	Vamp.....	6-20
Pulse Condition .....	5-10	Variable.....	6-12
Pulse Polarity .....	5-12	Vavg .....	6-20
Pulse Trigger .....	5-10	Vbase .....	6-20
Pulse Width Setting.....	5-11	Vectors .....	11-2
Qualifier .....	5-13	Vertical Expansion .....	2-7
Record Constant On.....	10-4	Vertical Scale .....	2-6
Rectangle .....	6-5	Vertical Window .....	5-13, 5-20
Reference Waveform.....	8-1	Video Polarity .....	5-22
Rise Time .....	6-17	Video Standard .....	5-23
Roll .....	3-7	Video Trigger .....	5-22
RS232 Decoding.....	7-5	VISA .....	13-6
RS232 Trigger .....	5-35	Vmax .....	6-20
Runt Trigger.....	5-12	Vmin.....	6-20
Sample Rate .....	4-6	Vpp .....	6-20
Setup/Hold Trigger .....	5-33	Vrms-1.....	6-21
Setups.....	12-3	Vrms-N .....	6-20
Slope Condition .....	5-19	Vtop .....	6-20
Slope Trigger.....	5-19	Waveform Analysis .....	10-8
SPI Decoding .....	7-14	Waveform Confusion .....	4-6
SPI Trigger.....	5-41	Waveform Distortion.....	4-6
Static IP .....	13-3	Waveform Invert.....	2-5
Subnet Mask .....	13-4	Waveform Leakage.....	4-7
Sync.....	5-22	Waveform Playback .....	10-6
Threshold .....	6-17, 6-24	Waveform Record.....	10-2
Time Setting .....	5-20	Waveforms .....	12-3
TimeOut Trigger .....	5-30	Window Function .....	6-5
Traces .....	12-3	Windows trigger.....	5-15
Track Mode .....	6-34	Windows Type .....	5-15
Trigger Coupling.....	5-4	X Cursor.....	6-29
Trigger Holdoff .....	5-5	XOR.....	6-9

---

X-Y .....	3-4	Y Cursor .....	6-29
X-Y mode .....	6-37	Y-T .....	3-4