

WT3000

Precision Power Analyzer

High-end Power Meter with top precision*
Basic Power Accuracy: 0.02% of reading

Precision Power Analyzer WT3000

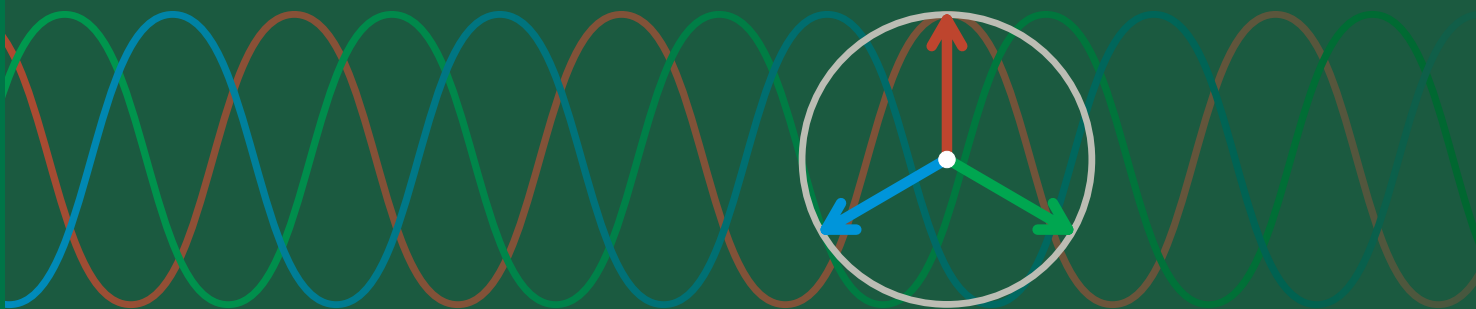

Basic Power Accuracy
0.02% reading

Frequency Power Range
DC, 0.1 Hz to 1 MHz

Use as many as
4 input elements

* Compared to previous Yokogawa model



Precision Power Analyzer WT3000

Yokogawa's power measurement technology provides best-in-class*¹ precision and stability

Precision Power Analyzer WT3000

APEX

Basic Power Accuracy: $\pm 0.02\%$

With basic power accuracy of $\pm 0.02\%$ of reading, DC and 0.1 Hz–1 MHz measurement bandwidths, and up to four input elements, the WT3000 provides higher-accuracy measurement of inverter I/O efficiency.



More Precise. More Bandwidth. More Features.*²

- The WT3000 is a truly innovative measurement solution, combining top-level measurement accuracy with special functions.*²
- The large, 8.4-inch liquid crystal display and the range indicator LEDs ensure good readability and make the system easy to use.

The WT3000 is the answer to your measurement problems.

Have you had problems or questions such as these?

- When working with efficiency-improvement evaluation data for a high-efficiency motor, improvements cannot be seen unless measurements are taken with very high precision.
- Measurement efficiency is poor during power measurements and power supply quality measurements.
- You measure voltage using mean values out of habit, and are wondering if that is really the best approach.

For answers to these questions, see page 6.

Features



Standard feature Option

Better Efficiency in Power Measurements

In developing the WT3000, Yokogawa focused on improving efficiency in two basic areas. One goal was to obtain highly precise and simultaneous measurements of the power conversion efficiency of a piece of equipment. The other objective was to improve equipment evaluation efficiency by making simultaneous power evaluations and tests easier and faster.

New Innovations to Enhance the Reliable Measurement Technology Developed for the WT2000

The Yokogawa WT2000 was very popular with users and considered highly reliable because of its high precision and excellent stability. The WT3000 is based on a measurement system which combines the measurement technology used in the WT2000 as well as other WT Series models. With the WT3000, we made further improvements to the basic performance specifications for even better functionality and reliability. We are confident users will appreciate these improvements to power and efficiency measurements thanks to the new power control technologies we have introduced.

A Variety of External Interface Choices

The WT3000 is the first model in the WT Series which is standard-equipped with a PC card slot (ATA flash card slot). This interface allows data to be saved quickly, so data processing time is reduced. The WT3000 is also standard-equipped with a GP-IB port. In addition, a serial (RS-232) port, Ethernet port*, and USB port* are available as options. The variety of interface choices allows customers to use the best interfaces for a wide variety of equipment, media, and network environments.

* Yokogawa plans to make an optional Ethernet port and USB port available. See page 5 for information on functions.



Yokogawa's highest-precision power meter*2

The WT3000 has the highest precision of the Yokogawa power meters in the WT Series. The models in the WT Series are designed to meet a wide variety of user needs. The WT200 Series is a high price-performance series which is very popular in production line applications. The WT1600 allows measurement data to be viewed in a variety of ways, including numerical value display, waveform display, and trend display capabilities.

WT3000
±0.02%

WT1600
±0.10%

WT210/WT230
±0.10%

*reading error



Select the model most suited to your measurement needs.

Standard Version

★High Accuracy and Wide Frequency Range

Basic Power Accuracy
±(0.02% of reading + 0.04% of range)
Frequency Range
DC, 0.1 Hz to 1 MHz

★Low Power Factor Error

Power factor influence when $\cos\phi=0$
0.03% of S
S is reading value of apparent power
 ϕ is phase angle between voltage and current

★Current Range

Direct Input
0.5/1/2/5/10/20/30 [A]

* Models with input elements supporting current output type current sensors are planned for release.

External Input

50m/100m/200m/500m/1/2/5/10 [V] *

★Voltage Range

15/30/60/100/150/300/600/1000 [V] *

* Voltage range and current range are for crest factor 3

★Continuous Maximum Common Mode Voltage (50/60 Hz)

1000 [Vrms]

★Data Update rate: 50 ms to 20 sec

★Effective input range: 1% to 130%

★Simultaneously measurement with 2 Units

★Standard PC Card Slot

Motor Version

★Calculation of Motor and Total Efficiency with Higher Accuracy

In addition to the functions of the standard version, the new models offer powerful motor/inverter evaluation functions.

★Voltage, Current, and Power Measurement with Torque and Speed Input

Measures torque meter and speed sensor output (analog or pulse output), and allows calculation of torque, revolution speed, mechanical power, synchronous speed, slip, motor efficiency, and total efficiency in a single unit.

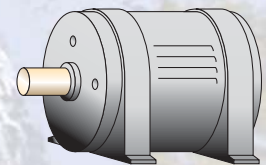

*1 As of November 2004, for power accuracy in a three-phase power meter (as investigated by Yokogawa)

*2 As compared to Yokogawa's WT2000

The design is currently in development. The appearance of the final product may differ somewhat.

The release dates of planned products and options vary from case to case.

FUNCTIONS

▶ WT3000 Controls: Simple to Use, Easy to View

The WT3000 was designed with user-friendly functions and controls in response to user requests for a simpler range setting operation and more user-friendly parameter setting display process.



Simpler range settings

Range settings using direct key input

The range indicator on the WT3000 is a seven-segment green LED, so the set range can be monitored at all times. The range can easily be switched using the up and down arrows.



Easier cursor navigation and numerical settings

Intuitive control using cursor keys

Cursor keys can be used to move the screen cursor in four different directions, so it is easy and intuitive to set scaling factor and other settings.



Item pages make it easy to set the data you want to view for each experiment

Using item pages to set display preferences

The WT3000 has nine item pages for displaying measurement values. Once you set the measurement parameters you want displayed on a particular item page, you can easily switch between entire groups of displayed parameters. For example, the following settings make it easy to switch and compare data:
 Page 1: Voltage, Current, Active Power, and Current Frequency for Input Element 1
 Page 2: Voltage, Current, Active Power, and Current Frequency for Input Element 2
 Page 3: Voltages for Input Elements 1, 2, 3, and 4
 Page 4: Currents for Input Elements 1, 2, 3, and 4
 Page 5: Power for Input Elements 1, 2, 3, and 4

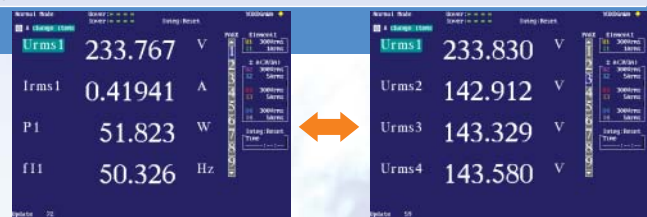

Easily switch between multiple item pages

▶ A wide range of standard functions

Formats for viewing waveforms as well as numerical values

A Variety of display formats

The WT3000 lets you display input signal waveforms in addition to numerical value data. This means you don't need to connect a special waveform analyzer just to check signal waveforms.¹

In addition, the optional harmonics measurement function lets you display vectors and bar graphs for enhanced visual presentation. The information display shows voltage range, current range, filter, and scaling value all together, making it easy to check your settings.

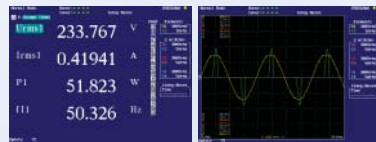

Numerical value display Waveform display

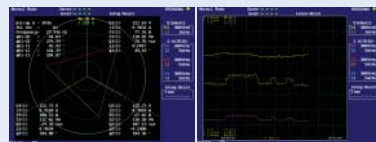

Vector display² Trend display

¹ Waveforms up to approximately 10 kHz can be displayed accurately.
² Requires the optional harmonics measurement function (/G5).

High-speed measurement to capture rapid data fluctuations

50ms data updating intervals

Fast updating allows you to precisely capture rapidly changing transient states in the measurement subject.

* The WT3000 switches between two different calculation systems depending on the data updating interval. See page 15 for details.

For increased measurement precision

Compensation functions

The WT3000 has compensation functions for high-precision measurements. These functions can compensate for instrument-related losses resulting from the power meter's internal impedance as well as losses related to wiring during measurement with two power meters. The following compensation functions are provided to compensate for instrument-related losses:

- **Efficiency Compensation:** This function compensates for instrument-related losses occurring during efficiency calculation.
- **Wiring Compensation:** This function compensates for instrument-related losses caused by wiring.

When measurements are performed using two power meters with three-phase three-wire wiring, errors may occur if current flows to the middle wire (or if there is a leakage current). The WT3000 has a function to compensate for such errors. Even when measurements are performed with two power meters (requires measurement with three-phase three-wire (3V3A) wiring), the current flowing to the middle wire is calculated, and a corresponding correction value can be added to the power measurement. This improves the accuracy of power measurements.

A way to add user-defined measurement parameters

User-defined function

As many as twenty user-defined formulas can be set in the WT3000. These equations can be used to calculate various parameters, such as mean active power (see "A variety of integration functions" below).

An easier way to input efficiency calculation formulas

Efficiency calculation function

This function can be used to set up to four efficiency calculation formulas.

Apparent power integration and reactive power integration

A Variety of integration functions

- **Active power, current, apparent power, reactive power**
 In addition to the active power integration function (WP) and current integration function (q) included in earlier models, the WT3000 also has a new apparent power integration function (WS) and reactive power integration function (WQ).
- **A wide effective input range for high-precision integration**
 The WT3000 has a wide effective input range, from 1% to 130% of the measurement range. This enables higher-precision integration measurements on measurement subjects with current values that fluctuate widely from large currents down to faint currents in the standby state.
- **Mean active power (using user-defined settings)**
 Mean active power can be calculated over an integration interval. This feature is useful for evaluating the power consumed by intermittent-control instruments in which the power value fluctuates.

$$\text{Mean active power} = \frac{\text{Integrated power (WP)}}{\text{Integrated elapsed time (H)}}$$

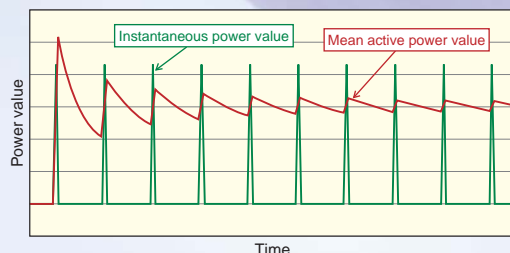

OPTIONS

► A wide variety of optional functions make it easy to perform sophisticated power evaluations.

When you purchase a WT3000 from Yokogawa, you get to select just the options you need. This approach lets you maximize performance at a lower cost.

Checking phase voltage when you measure line to line voltage

Delta Calculation (/DT)

This function allows you to calculate individual phase voltages from the line to line voltage measured in a three-phase, three-wire system. This is useful when you want to determine the phase voltage in motors and other items under test with no neutral lines. Line to line voltage and phase current (measurements equivalent to 3V/3A) can be estimated in systems not measured from a three-phase, three-wire configuration (using two elements).

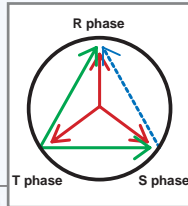

Phase voltage (red arrow) and the other line to line voltage (the blue dashed arrow), which is not measured directly, can be calculated and displayed based on the three-phase, three-wire system's line to line voltage (green arrows).

Checking harmonic components when a waveform is distorted

Harmonic Measurement Function (/G5)

Representing an improvement over our previous models, the WT3000 is able to measure normal and harmonic measurement data simultaneously. With the WT3000, you can measure distortion factor (THD) and simultaneously monitor total voltage, current, and distortion factor without altering the measuring modes. Also, you can calculate phase angle of three phase power between phases or across input elements.

* Option /G5 cannot perform harmonic measurements in compliance with IEC61000-3-2.

Checking the frequencies of all inputs

Added Frequency Measurement (/FQ)

In addition to the standard two channels of frequency measurement, a six-channel frequency measurement option is also available. This option provides frequency measurement of voltage and current on all eight channels (with input elements 1 through 4 installed). This is necessary when you want to measure voltage and current frequency from the instrument's I/O as well as voltage and current frequencies of multiple items under test at the same time.

Outputting measurement values as analog signals to other devices

D/A Output (/DA)

• 20 Channels

Measured values can be output as $\pm 5V$ FS DC voltages from the D/A output connector on the rear panel. Measured parameters can be output on up to twenty channels simultaneously. Even with four input elements installed, you can send up to five types of data per element to D/A output.

• D/A zoom

Normally the D/A output function outputs DC voltage scaled to a range of $-5V$ to $5V^*$ with respect to the measurement range. For this reason, it may not be possible to observe fluctuations in a nearly constant signal if the D/A output is set to go to $\pm 5V$ at the measurement range rated value. One case in which this could happen is when a 100V measurement voltage fluctuates in the range of $\pm 3V$.

The WT3000 has a D/A zoom function to solve such problems. This function allows the any input signal range to be scaled to between $-5V$ and $5V^*$ in the D/A output as Upper and Lower ranges. This makes it possible to enlarge input signal fluctuations for observation using a recorder or logger.

* The range is 0V to 5V for some functions, such as frequency measurement.

Output graphics at the touch of a button

Built-in printer (/B5)

The optional built-in printer is installed on the front side of the WT3000, so it is easy to use even if the WT3000 is mounted on a rack. The printer can be used to print data and waveform memos.



Video output for viewing on a larger screen

VGA output (/V1)

The VGA port can be used to connect an external monitor in order to view numerical value data and waveforms on a larger screen. This capability is useful if you want to simultaneously check large amounts of data on a separate screen, or view data in a separate location.

Serial (RS-232) (/C2)

► Future Release Plans

Ethernet port (/C7)

The optional Ethernet port (100BASE-TX/10BASE-T) allows you to connect the WT3000 to a LAN. Once connected, images and numerical value data saved on the WT3000 can be transferred to a PC using FTP server software or other utilities.

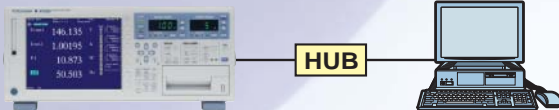

With a LAN setup, it is possible to use a PC at your company's main office to collect measurement data from WT3000 units installed in individual factories. This eliminates the need to make trips between a main office and factories in order to read and save measurement values recorded at the factories.

Email sending function: This function allows you to send data in email messages at fixed intervals or specified times. It is useful for monitoring data.

Network printer function: This function allows you to output WT3000 screen images to a network printer.

USB communication and USB memory (/C5, /C12)

A USB port can be added to the WT3000 for connection to a PC. A USB connection can be used to control the power meter and download data from it. Data can also be saved to the USB memory.

IEC harmonic measurement (/G6)

This function enables harmonic measurements in compliance with IEC61000-3-2. In addition, it can measure up to 50 orders of harmonics on signals from the fundamental wave frequency up to 1 kHz (or up to 20 orders in the range of 1 kHz to 2.5 kHz).

Flicker measurement (/FL)

This function enables measurement of voltage fluctuations/flicker in compliance with EN61000-3-3 (Ed1:1995). It can measure relative working voltage change, maximum relative voltage change (dmax), relative voltage change time (dt), short-term flicker value (Pst), and long-term flicker value (Plt). The initial limit values for the individual parameters are set in accordance with the IEC standard.

APPLICATIONS

▶ Measurement Applications to Utilize WT3000's Capabilities

Measurement of Inverter Efficiency

• Measuring Efficiency with High Precision: Simultaneous Measurement of Input and Output

When taking efficiency measurements of power converters, it is important to be able to measure input and output at the same timing. The WT3000 offers up to four input elements capable of simultaneous measurement of single-phase input/three-phase output, or three-phase input/three-phase output.

• Accurate Measurement of Fundamental PWM Voltage Waveforms
In evaluating inverter drive motors, one of the critical measurement parameters is the fundamental component of voltage. The voltage MEAN is typically used for voltage measurement of sinewave-modulated PWM waveforms, due to the fact that the measured value from the voltage MEAN (rectified mean value calibrated to the RMS value) is similar to the fundamental component of voltage. However, motor drive technology has become more complex in recent years; pure sinewave-modulated PWM is less common, and cases in which the voltage mean differs greatly from the fundamental voltage waveform arise frequently. With the optional harmonic measurement function of the WT3000 (the /G5 option), accurate measurements of commonly measured values such as active power and the fundamental or harmonic components can be taken simultaneously without changing measuring modes.

• Phase Voltage Measurement without a Neutral Line
With the delta computation function (/DT option), an object under test without a neutral line can be measured in a three-phase three-wire configuration, allowing calculation of each phase voltage.

• Achieving Higher Precision: Measuring Instrument Loss Correction Function
Instrument loss caused by the input resistance of the measuring device is, in principle, an unavoidable problem. Yet you can overturn conventional wisdom and obtain higher measurement accuracy by compensating for any potential instrument loss in the measured values.

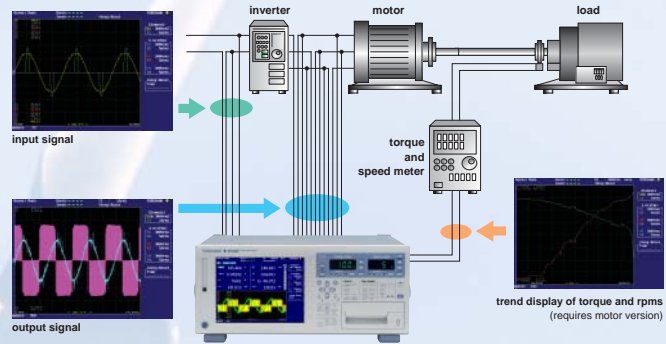

When measuring three-phase input/three-phase output with a three-phase four-wire system, you can measure input and output simultaneously by synchronizing between two units.

• Related applications
Power conversion technologies such as those used in EVs and power conditioners
High-precision, simultaneous measurements are required in measuring conversion efficiency in the conversion of a converter's three-phase input to a DC bus, and the conversion from an inverter's DC bus to three-phase output.

Evaluation of Lighting Devices

• Simultaneous Measurement of Voltage, Current, and THD (Total Harmonic distortion)

Testing of lighting devices often involves measurement of voltage, current, and THD, a parameter that indicates the quality of power. This is because distortion in voltage and current waveforms is becoming more prevalent due to the increasing complexity of control systems.

The WT3000 can simultaneously measure voltage and current with THD, eliminating these inconveniences and allowing for more accurate and rapid measurements of an instrument's characteristics and fluctuations.

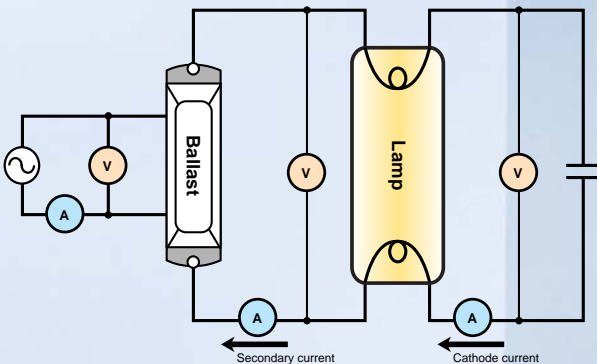

* THD stands for *total harmonic distortion*. In other words, the distortion factor.
* Please be aware that during lighting testing, the measured values and efficiencies may not be stable since the power conversion efficiency fluctuates over time due to the emission of heat.

■ Lamp Current Measurement
Since lamp current flows inside of fluorescent tubes, normally it cannot be measured directly. However, lamp current can be displayed by measuring secondary current and cathode current and finding the difference in their instantaneous values using the delta computation function (/DT option).

• Related applications
Evaluation of power quality in equipment designed to be connected in a system, such as UPSs and power conditioners

High Accuracy Measurements of Transformers

• High Accuracy Even at Low Power Factors
The WT3000 represents great improvement over previous models in terms of power factor error (it is approximately three times more accurate). With improved measurement accuracy in the lower power factors—such as with transformers, active power values can be measured with higher precision.

• Simultaneous Measurement of RMS and MEAN of Voltage
Voltage RMS (the true RMS value) and voltage MEAN (rectified mean value calibrated to the rms value) can be measured at the same time, allowing for measurement of corrected power (Pc) and other measurements conforming to transformer evaluation standards.

• Phase Voltage Confirmation
The delta computation function (/DT option) allows both star-delta and delta-star conversion. For example with delta wiring, you can check the line voltage and phase voltage simultaneously without changing the wiring.

Reference equipment for power calibration

• Basic power accuracy of ±0.02% of reading
The WT3000 can be used as a reference instrument for periodic in-house calibration of general-purpose power measurement instruments, such as the WT210 and WT230.



Temperature- and humidity-controlled calibration room

Harmonic measurements

• Harmonic measurements in compliance with IEC61000-3-2
The WT3000 can be used to perform harmonic measurements in compliance with EN61000-3-2 (Ed2:2000). Note that this capability requires the /G6 option, which Yokogawa is planning to release. Yokogawa also plans to release a very useful software application.

• Measurement of up to 50 orders of harmonics at 1 kHz
The WT3000 is useful for evaluating harmonics in equipment such as aircraft, in which the fundamental frequency changes to harmonics. Note that this capability requires the /G6 option, which Yokogawa is planning to release.

• Harmonic measurements on four input elements
The WT3000 can also be used to observe changes in the harmonic distortion factor in each phase. Note that this capability requires the /G5 option.

• Measurement of phase angles between phases
The WT3000 can determine the phase angle formed between the voltage fundamental wave of input element 2 or 3, and the voltage fundamental wave of input element 1. It can also determine the phase angle formed between the current fundamental wave of input element 1, 2 or 3, and the voltage fundamental wave of input element 1. Note that this capability requires the /G5 option.

SOFTWARE

► Future Software Releases

Software for Standards-Compliant Measurements

- **Communications: GP-IB or Ethernet (/C7)**
- **Harmonic measurement function (requires /G6 option)**

Harmonics can be judged as acceptable or unacceptable in accordance with standards classifications (A, B, C, and D). In addition to simply listing measurement values, the WT3000 can also display bar graphs, current fluctuation graphs, and evaluation graphs. Bar graphs can be used to compare measurement values and standard limit values for each harmonic component. Current fluctuation graphs are displayed in time series, and evaluation graphs can be used to identify by color whether each harmonic order is acceptable.

The final harmonic measurement results can be printed as numerical value lists or graphs, or saved as image data. Titles and comments can be added to reports, so information such as measurement dates and times, equipment names, and tracking numbers can be added.

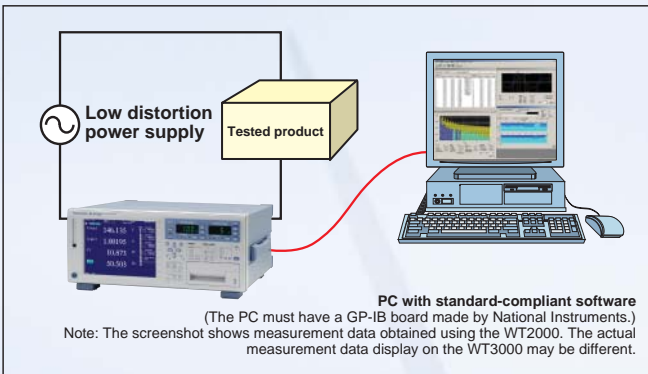

Yokogawa plans to make this software compatible with standards starting with EN61000-3-2 Ed2:2000;2001/January 1. EN61000-3-2 Ed2:2000 was applied starting in January 2001, and the migration period extended to December 31, 2003. Starting in 2004, the standard EN61000-3-2 Ed2:2000 is applied.

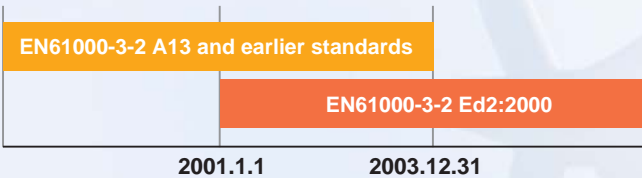

Note: This software supports EN61000-3-2 Ed2:2000, so it does not have a mode permitting measurement based on the older EN61000-3-2 standards.

• Flicker measurement function*

This function enables voltage fluctuation and flicker measurements in compliance with EN61000-3-3 (Ed1:1995).

Note: The screenshot shows measurement data obtained on the WT2000 using the flicker measurement software designed for the WT2000. The measurement data display on the WT3000 may be different.

* requires /FL option

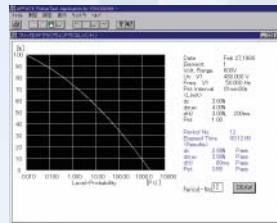

LabVIEW Driver (free)

Yokogawa plans to release a LabVIEW driver. It is easy to collect data using LabVIEW.



Note: The screenshot is a display example from the WT1600. The display on the WT3000 may be different.

* LabVIEW is a registered trademark of National Instruments Corporation.

WTViewer

- **Communications: GP-IB, Serial (RS-232, /C2), or Ethernet (/C7)**

WTViewer is an application software tool that reads numeric, waveform, and harmonic data measured with the WT3000 Precision Power Analyzer. Data can be transferred into your personal computer via Ethernet, GP-IB (parallel) or RS-232 (serial) communications. It lets you view waveforms on your computer, convert numeric or waveform data to a specified format, and store the data.

• Numeric Data

WTViewer can simultaneously display voltage, current, power and various other measured parameters for one to four elements individually, and for ΣA and ΣB calculations.

No.	Function	Element	Data	Units
1	V	I	59.810	V
2	A	I	0.245	A
3	W	I	15.48	W
4	VA	I	24.44	VA
5	var	I	18.32	var
8	PF	I	0.8333	
7	dag	I	G 56.7	
8	VHz	I	48.952	Hz
9	AHz	I	Error	Hz
10	Wh	I	499.00m	Wh
11	Wh+	I	505.50m	Wh
12	Wh-	I	-6.8681m	Wh
13	V/A	I	-1.4	V/A

• Measuring Harmonics*

WTViewer can numerically or graphically display the results of measured harmonics up to the 100th order for such parameters as voltage, current, power and phase angle.

* requires /G5 or /G6 option

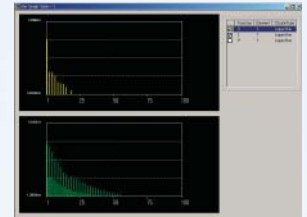

• Vectorial Views

In harmonic measurement mode you can view a vectorial display of the fundamental voltage, current and phase angle. This visual presentation of the interphase relationship in a three-phase power system shows the load condition intuitively.

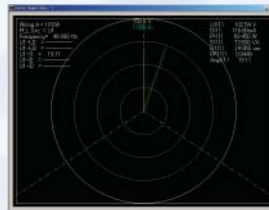

• Viewing Trends

You can capture and view various types of data, measured with the WT3000 on your PC in a graphical trend format. This feature lets you monitor power supply voltage fluctuations, changes in current consumption and other time-based variations.

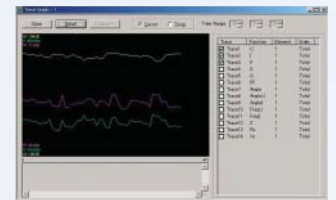

• Setting Up the WT3000 from a PC

With WTViewer, you can control the WT3000 main unit from your PC, including setting the wiring method, range, filter, scaling, and so on. WTViewer also lets you save or read the settings of the WT3000 onto your PC.

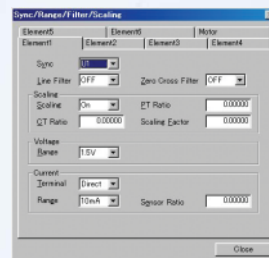

• Converting Data to CSV Format

With WTViewer, you can save waveform and numeric data to your PC. From the PC you can create *.wtd files that can be loaded in WTViewer, or *.csv files that can be imported into Excel spreadsheets.

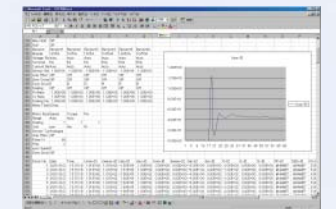

Example data in Excel

• FTP client function*

This function allows data stored on the WT3000's PC card to be transferred to a PC for displaying and conversion.

* requires /C7 option



Note: The screenshot is a display example from the WT1600. The display on the WT3000 may be different.
 * Excel is a registered trademark of Microsoft Corporation.

REAR PANEL

▶ Rear Panel



Standard features

- ① Voltage input terminals
- ② Current external sensor input terminals
- ③ Current direct input terminals
- ④ GP-IB port
- ⑤ BNC connector for two-system synchronized measurement

Optional features

- ⑥ Serial (RS-232) port (option/C2)
- ⑦ Ethernet port (100BASE-TX/10BASE-T) (option/C7)
- ⑧ VGA port (option/V1)
- ⑨ D/A output (option/DA)
- ⑩ Torque and speed input terminals (motor version)

CHARACTERISTICS

▶ Example of basic characteristics showing the WT3000's high precision and excellent stability

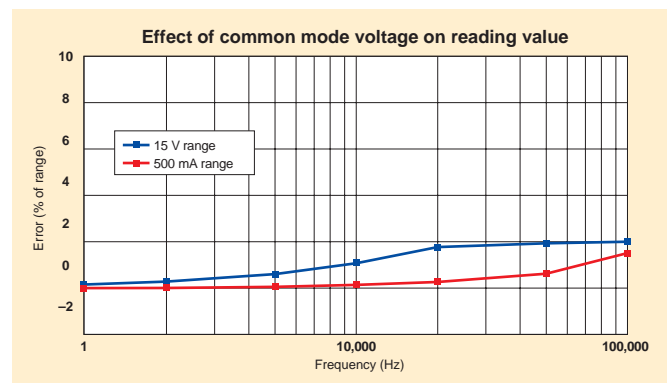
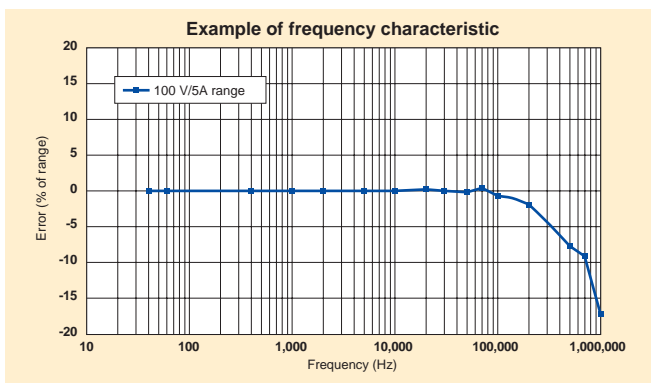
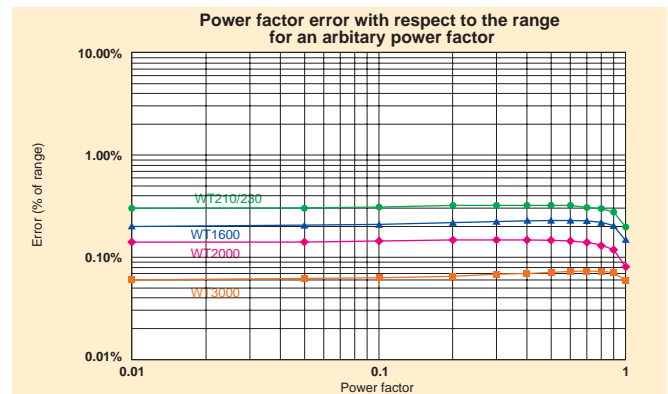
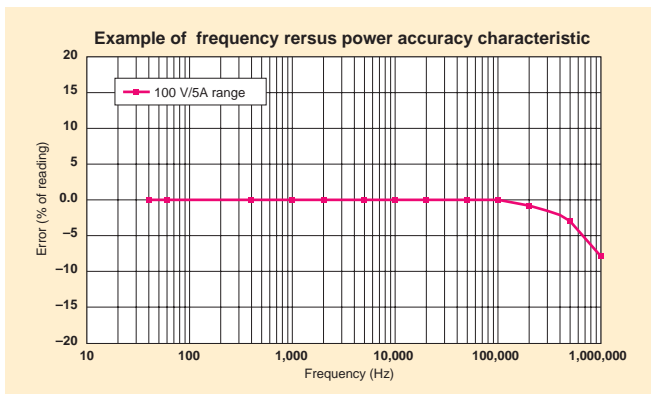

SUPPORTS Crest Factor 6

The crest factor is the ratio of the waveform peak value and the RMS value.

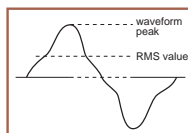

$$\text{Crest factor (CF, peak factor)} = \frac{\text{waveform peak}}{\text{RMS value}}$$

When checking the measurable crest factor of our power measuring instruments, please refer to the following equation.

$$\text{Crest factor (CF)} = \frac{\{\text{measuring range} \times \text{CF setting (3 or 6)}\}}{\text{measured value (RMS)}}$$

* However, the peak value of the measured signal must be less than or equal to the continuous maximum allowed input

* The crest factor on a power meter is specified by how many times peak input value is allowed relative to rated input value. Even if some measured signals exist whose crest factors are larger than the specifications of the instrument (the crest factor standard at the rated input), you can measure signals having crest factors larger than the specifications by setting a measurement range that is large relative to the measured signal. For example, even if you set CF = 3, CF5 or higher measurements are possible as long as the measured value (RMS) is 60% or less than the measuring range. Also, for a setting of CF = 3, measurements of CF = 300 are possible with the minimum effective input (1% of measuring range).

ACCESSORIES

▶ Related products

Current Sensor Unit Current Transducer Current Clamp on Probe



751521, 751523 Current Output
Current Sensor Unit
DC to 100kHz/600Apk

- Wide dynamic range: -600 A to 0 A to +600 A (DC)/600 A peak (AC)
 - Wide measurement frequency range: DC to 100 kHz (-3 dB)
 - High-precision fundamental accuracy: $\pm(0.05\% \text{ of rdg} + 40 \text{ mA})$
 - Superior noise withstanding ability and CMRR characteristic due to optimized casing design
- *751521/751523 do not conform to CE Marking
 For detailed information, see Power Meter Accessory Catalog Bulletin 7515-52E.



751574 Current Output
Current Transducer
DC to 100 kHz/600Apk

- Wide measurement frequency range: DC and up to 100 kHz (-3 dB)
 - High-precision fundamental accuracy: $\pm(0.05\% \text{ of reading} + 40 \text{ mA})$
 - Wide dynamic range: 0-600 A (DC)/600 A peak (AC)
 - $\pm 15 \text{ V DC}$ power supply, connector, and load resistor required.
- For detailed information, see Power Meter Accessory Catalog Bulletin 7515-52E.



751552 Current Output
Current Clamp on Probe
AC1000Arms (1400Apeak)

- Measurement frequency range: 30 Hz to 5 kHz
 - Basic accuracy: $\pm 0.3\% \text{ of reading}$
 - Maximum allowed input: AC 1000 Arms, max 1400 Apk (AC)
 - Current output type: 1 mA/A
- A separately sold fork terminal adapter set (758921), measurement leads (758917), etc. are required for connection to WT3000. For detailed information, see Power Meter Accessory Catalog Bulletin 7515-52E.



96001 Voltage Output
Current Clamp on Probe
AC400Arms (600Apeak)

- Measurement frequency range: 20 Hz to 20 kHz
 - Basic accuracy: 1.0% of reading + 0.2 mV (40 Hz to 1 kHz)
 - Maximum allowed input: AC 400 Arms
 - Voltage output type: 10 mV/A
- A separately sold adapter (758924) is required for connection to WT3000. This is a Yokogawa M&C Product. For detailed information, see <http://www.yokogawa.com/MCC>

Adapters and Cables

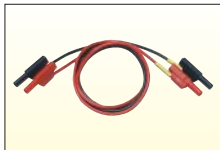

758917
Measurement leads
 Two leads in a set. Use 758917 in combination with 758922 or 758929.
 Total length: 75 cm
 Rating: 1000 V, 32 A



758922 ⚠
Small alligator adapters
 For connection to measurement leads (758917). Two in a set.
 Rating: 300 V



758929 ⚠
Large alligator adapters
 For connection to measurement leads (758917). Two in a set.
 Rating: 1000 V



758923*1
Safety terminal adapter set
 (spring-hold type) Two adapters in a set.



758931*1
Safety terminal adapter set
 Screw-fastened adapters. Two adapters in a set. 1.5 mm Allen wrench included for tightening.



758921 ⚠
Fork terminal adapter
 Two adapters (red and black) to a set. Used when attaching banana plug to binding post.



758924
Conversion adapter
 For conversion between BNC and female banana plug



366924*2 ⚠
BNC cable
 BNC-BNC 1m. For connection to simultaneously measurement with 2 units, or for input external trigger signal.



366925*2 ⚠
BNC cable
 BNC-BNC 2m. For connection to simultaneously measurement with 2 units, or for input external trigger signal.

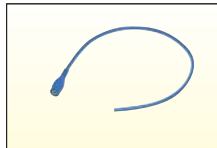

B9284LK ⚠
External Sensor Cable
 For connection the external input of the WT3000 to current sensor.
 Length: 50cm

⚠ Due to the nature of this product, it is possible to touch its metal parts. Therefore, there is a risk of electric shock, so the product must be used with caution.

*1 Diameters of cables that can be connected to the adapters

758923 core diameter: 2.5 mm or less;

sheath diameter: 5.0 mm or less

758931 core diameter: 1.8 mm or less;

sheath diameter: 3.9 mm or less

*2 Use with a low-voltage circuit (42V or less)

*3 The coax cable is simply cut on the current sensor side. Preparation by the user is required.

Connecting Diagram

Connecting the Measurement Cables and Adapters

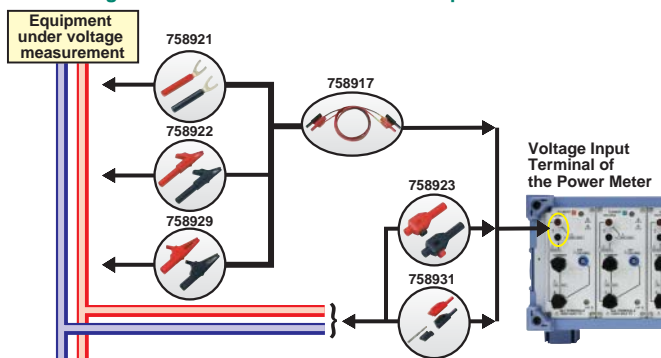

Connecting Diagram for Clamp-on Probe

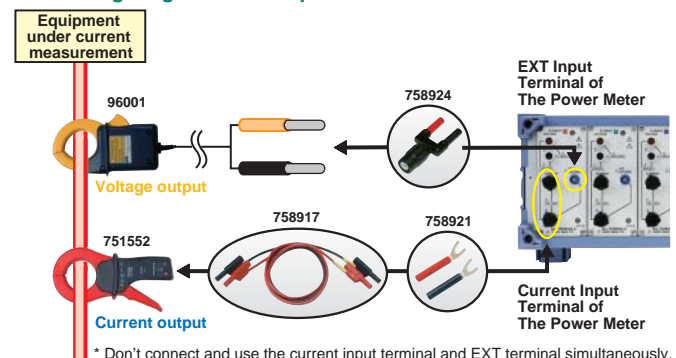

Measurement Parameters and Optional Functions

Measurement Parameters and Optional Functions

The following tables show the parameters that can be measured with the standard version and motor version, as well as the parameters that can be displayed with optional features. You can select the particular options which support the parameters you want to measure.

Measurement parameters for basic model

Model	Parameter group	Measurement parameter	Normal mode					
			Normal measurement	Total for each order	DC	Fundamental wave	Each order	
Standard version (-SV) and motor version (-MV)	Normal measurement data	Voltage RMS	✓ *1			✓	✓	
		Voltage MEAN	✓ *1					
		Voltage DC	✓ *1		✓			
		Voltage RMEAN	✓ *1					
		Current RMS	✓ *1				✓	
		Current MEAN	✓ *1					
		Current DC	✓ *1		✓			
		Current RMEAN	✓ *1					
		Voltage peak (forward, backward), current peak (forward, backward)	✓					
		Voltage or current crest factor *2	✓					
		Voltage or current frequency (up to two)	✓					
		Power factor	✓					
		Active power, apparent power (select TYPE1 or 2), reactive power (select TYPE1 or 2)	✓		✓	✓	✓	
		Apparent power (when TYPE3 is selected)	✓	✓	✓	✓	✓	
		Reactive power (when TYPE3 is selected)	✓	✓	✓	✓	✓	
	Corrected Power P _c *2	✓						
	Phase data	Load circuit impedance, load circuit serial resistance, load circuit serial reactance, load circuit parallel resistance, load circuit parallel reactance	✓		✓	✓	✓	
		Voltage harmonic content, current harmonic content, active power harmonic content, voltage total harmonic distortion factor, current total harmonic distortion factor, active power total harmonic distortion factor	✓	✓				
		Telephone harmonic factor, telephone influence factor, harmonic voltage factor, harmonic current factor	✓	✓				
		Voltage and current phase difference	✓	✓		✓	✓	
		Phase difference between voltage fundamental wave of input element 2 or 3, and voltage fundamental wave of input element 1	✓			✓		
		Phase difference between current fundamental wave of input element 1, 2 or 3, and voltage fundamental wave of input element 1	✓			✓		
		Voltage and current fundamental waves and phases for each order	✓			✓	✓	
		Integration time, active power amount (forward and backward, forward, backward), current amount (forward and backward, forward, backward), apparent power amount, reactive power amount	✓					
		Efficiency 1, 2, 3, 4	✓					
		User-defined functions 1-20 *3	✓					
		Σdata	Voltage, current, active power, apparent power, reactive power, power factor, phase difference	✓			✓	
			Corrected Power P _c	✓			✓	
			Integrated active power amount (forward and backward, forward, backward)	✓				
		Motor version (-MV)	Motor-related data	Torque, rotational velocity, synchronized velocity, slippage, motor output	✓			

Measurement parameters enabled by optional features

Option	Parameter group	Measurement parameter	Display mode
Delta calculation (/DT)	Utilif	Delta calculated voltage RMS, MEAN, RMEAN, DC *1	Normal measurement
	Utilif	delta calculated current RMS, MEAN, RMEAN, DC *1	
	3P3W-3V3A	Delta calculated voltage RMS, MEAN, RMEAN, DC *1; delta calculated current RMS, MEAN, RMEAN, DC *1	
	Delta-Star	Delta calculated voltage RMS, MEAN, RMEAN, DC *1; delta calculated current RMS, MEAN, RMEAN, DC *1	
Frequency measurement addition (/FQ)	Star-Delta	Delta calculated voltage RMS, MEAN, RMEAN, DC *1; delta calculated current RMS, MEAN, RMEAN, DC *1	Normal measurement
	Frequency data	Voltage or current frequency on the number of channels added in addition to the standard two channels (measurements can be made on up to eight channels)	

The optional built-in printer (/B5), 20-channel D/A output (/DA), VGA output (/V1), and RS-232 serial port (/C2) are not directly related to measurement parameters.

*1 Only one of the measurement parameters (RMS, MEAN, RMEAN, DC), selected according to the measurement mode, can be displayed.

*2 Can only be displayed when RMS is selected according to the measurement mode.

*3 Voltage RMS and Voltage MEAN can be measured simultaneously using a user-defined calculation.

Comparison of Specifications and Functions in WT3000, Other WT Series Models, and PZ4000

	WT3000	WT2000	WT1600	PZ4000	
Range	Basic power accuracy (50/60 Hz)	0.02% of reading + 0.04% of range	0.04% of reading + 0.04% of range	0.1% of reading + 0.05% of range	
	Measurement bandwidth	DC, 0.1 Hz to 1 MHz	DC, 2 Hz to 500 kHz (voltage, current) DC, 2 Hz to 300 kHz (power)	DC, 0.5 Hz to 1 MHz	
	Input elements	1, 2, 3, 4	1, 2, 3	1, 2, 3, 4, 5, 6	
	Voltage range	15/30/60/100/150/300/600/1000[V] (when crest factor is 3) 7.5/15/30/50/75/150/300/500[V] (when crest factor is 6)	15/30/60/100/150/300/600[V] (for crest factors 3 and 6)	1.5/3/6/10/15/30/60/100/150/300/600/1000[V] (when crest factor is 3) 750m/1.5/3/5/7.5/15/30/50/75/150/300/500[V] (when crest factor is 6)	30/60/120/200/300/600/1200/2000[Vpk]
Current range	Direct input	0.5/1/2/5/10/20/30[A] (when crest factor is 3) 0.25/0.5/1/2.5/5/10/15[A] (when crest factor is 6)	1/2/5/10/20/30 [A] (for crest factors 3 and 6)	Select from 10m/20m/50m/100m/200m/500m/1/2/5[A] or 1/2/5/10/20/50[A] (when crest factor is 3) 5m/10m/25m/50m/100m/250m/500m/1/2.5[A] or 0.5/1/2.5/5/10/25[A] (when crest factor is 6)	
	External sensor input	50m/100m/250m/500m/1/2/5/10[V] (when crest factor is 3) 25m/50m/125m/250m/500m/1/2.5/5[V] (when crest factor is 6)	50m/100m/200m[V] (for crest factors 3 and 6)	50m/100m/250m/500m/1/2.5/5/10[V] (when crest factor is 3) 25m/50m/125m/250m/500m/1.25/2.5/5[V] (when crest factor is 6)	
Guaranteed accuracy range for voltage and current ranges	1% to 130%	10% to 130%	1% to 110%	5% to 70%	
Measurement parameters	Voltage, current, active power, reactive power, apparent power, power factor, phase angle, peak voltage, peak current, crest factor				
	Main measurement parameters	✓	✓	✓	
	Peak hold (instantaneous maximum value hold)	✓	✓	✓	
	MAX hold	✓	✓	✓	
	Voltage RMS/MEAN simultaneous measurement	✓	(see note)	✓	
	RMS/MEAN/AC/DC simultaneous measurement	✓	✓	✓	
	Mean active power	✓ (user-defined function)	✓	✓ (user-defined function)	
	Active power amount (WP)	✓	✓	✓	
	Apparent power amount (WS)	✓	✓	✓	
	Reactive power amount (WQ)	✓	✓	✓	
	Frequency	2 channels (up to 8 channels with option /FQ)	One from voltages or currents on installed input elements	Up to three from voltages or currents on installed input elements	All installed voltages and currents (up to 8 channels)
	Efficacy	✓	✓	✓	✓
	Phase angle between phases (fundamental wave)	(/G5, /G6) (/G6 is being planned)(opt.)	✓	✓	✓
	Motor evaluation	Torque, rotational velocity input (motor version)(opt.)		Torque and rotational velocity input(opt.)	Torque and rotational velocity input (requires sensor input module 23371)(opt.)
	FFT spectral analysis	Planned for release (/G6)(opt.)			
User-defined functions	✓ (20 functions)		✓ (4)	✓ (4)	
Display resolution	Voltage, current, power	600,000	50,000	60,000	
	Power amount, current amount	999,999	500,000	999,999	
	Frequency	99,999	199,999	99,999	
Display	Display	8.4-inch TFT color LCD	7-segment display	6.4-inch TFT color LCD	
	Display format	Numerical values, waveforms, trends, bar graphs, vectors	Numerical values (4 values)	Numerical values, waveforms, trends, bar graphs, vectors	
	Sampling frequency	Approximately 200 kS/s	Approximately 110 kS/s	Approximately 200 kS/s	
	Harmonic measurement	(/G5, /G6) (/G6 is being planned)(opt.)	(opt.)	✓	
Measurement functions	IEC standards-compliant harmonic measurement	Planned for release (/G6)(opt.)	(opt.)	✓	
	Flicker measurement	Planned for release (/FL)(opt.)	(opt.)		
	Compensation function	✓			
	Delta calculation function	(/DT)(opt.)			
	DA output	20 channels (/DA)(opt.)	14 channels	30 channels(opt.)	
	Synchronized operation	✓		✓	
Other features	Storage (internal memory for storing data)	Planned for release, approximately 30MB (with /G5; not yet determined for /G6)		Approximately 11MB	
	Interfaces	VGA output (/V1)(opt.); Ethernet (/C7 is being planned)(opt.)	GP-IB or RS-232	SCSI(opt.); Ethernet(opt.); VGA output	
	Communication command compatibility	None (communication commands vary from product to product)			
	Communication command standards	Commands in IEEE488.2 standard	IEEE standard 488.2 or earlier command system and IEEE488.2 commands	Commands in IEEE488.2 standard	Commands in IEEE488.2 standard
Data updating interval	50m/100m/250m/500m/1/2/5/10/20[S]	250m/500m/2[S]	50m/100m/200m/500m/1/2/5[S]	Depends on waveform acquisition length and calculations	
Removable storage	PC card interface: USB (C7 and C12 are being planned)(opt.)		FDD	FDD	
Printer	Built-in printer (front side) (/B5)(opt.)	Built-in printer (front side)(opt.)	Built-in printer (front side)(opt.)	Built-in printer (top side)(opt.)	

There are limitations on some specifications and functions. See the individual product catalogs for details.

(opt.) Optional

WT3000 SPEC

WT3000 Specifications

Inputs	
Item	Specification
Input terminal type	Voltage Plug-in terminal (safety terminal)
	Current • Direct input: Large binding post • External sensor input: Insulated BNC connector
	Input type Voltage Floating input, resistive potential method Current Floating input, shunt input method
Measurement range	Voltage 15 V, 30 V, 60 V, 100 V, 150 V, 300 V, 600 V, 1000 V (for crest factor 3) 7.5 V, 15 V, 30 V, 50 V, 75 V, 150 V, 300 V, 500 V (for crest factor 6)
	Current • Direct input 500 mA, 1 A, 2 A, 5 A, 10 A, 20 A, 30 A (for crest factor 3) 250 mA, 500 mA, 1 A, 2.5 A, 5 A, 10 A, 15 A (for crest factor 6) • External sensor input 50 mV, 100 mV, 200 mV, 500 mV, 1 V, 2 V, 5 V, 10 V (for crest factor 3) 25 mV, 50 mV, 100 mV, 250 mV, 500 mV, 1 V, 2.5 V, 5 V (for crest factor 6)
	Instrument loss (input resistance) Voltage Approximately 10 MΩ // 5 pF Current • Direct input: Approximately 5.5 mΩ + approximately 0.03 μH • External sensor input: Approximately 1 MΩ
Instantaneous maximum allowed input (1 second or less)	Voltage Peak voltage of 2.5 kV or RMS of 1.5 kV, whichever is lower
	Current • Direct input: Peak current of 150 A or RMS of 50 A, whichever is lower • Current sensor input: Peak not to exceed 10 times the range
	Continuous maximum allowed input Voltage Peak voltage of 1.6 kV or RMS of 1.1 kV, whichever is lower
Continuous maximum common mode voltage (50/60 Hz)	Current • Direct input: Peak current of 90 A or RMS of 33 A, whichever is lower • Current sensor input: Peak not to exceed 5 times the range
	1000 Vrms
	Influence from common mode voltage Apply 1000 Vrms with the voltage input terminals shorted and the current input terminals open. • 50/60 Hz: ±0.01% of range or less • Reference value up to 200 kHz Voltage: ±3/range * % of range or less. However, 3% or less. Current direct input and current sensor input: ± (max. range/range) * 0.001 * % of range or less. However, 0.01% or less. The units of f are kHz. The maximum rated range within equations is 30 A or 10 V.
Line filter	Select OFF, 500 Hz, 5.5 kHz, or 50 kHz.
Frequency filter	Select OFF, or ON
A/D converter	Simultaneous voltage and current conversion and 16-bit resolution. Conversion speed (sampling rate): Approximately 5 μsec. See harmonic measurement items for harmonic display. Approximately 10 μsec for flicker display.
Range switching	Can be set for each input element.
Trigger range functions	Increasing range value • When the measured values of U and I exceed 110% of the range rating • When the peak value exceeds approximately 330% of the range rating (or approximately 660% for crest factor 6)
	Decreasing range value • When the measured values of U and I fall to 30% or less of the range rating, and Upk and Ipk are 300% or less of the lower range value (or 600% for crest factor 6)

Display	
Display	8.4-inch color TFT LCD monitor
Total number of pixels*	640 (horiz.) x 480 (vert.) dots
Waveform display resolution	501 (horiz.) x 432 (vert.) dots
Display update rate	Same as the data update rate. However, the rate is 250 msec when the data update rate is 50 or 100 msec

* Up to 0.02% of the pixels on the LCD may be defective.

Calculation Functions

		Single-phase, 3 wire	3 phase, 3 wire	3 phase, 3 wire (3 voltage 3 current)	3 phase, 4 wire
UΣ	[V]	(U1+U2)/2		(U1+U2+U3)/3	
IΣ	[A]	(I1+I2)/2		(I1+I2+I3)/3	
PΣ	[W]	P1+P2			P1+P2+P3
SΣ	[VA]	TYPE1	S1+S2	$\frac{\sqrt{3}}{2} (S1+S2)$	$\frac{\sqrt{3}}{3} (S1+S2+S3)$
		TYPE2			
		TYPE3	$\sqrt{P\Sigma^2+Q\Sigma^2}$		
QΣ	[var]	TYPE1	Q1+Q2		Q1+Q2+Q3
		TYPE2	$\sqrt{S\Sigma^2-P\Sigma^2}$		
		TYPE3	Q1+Q2		Q1+Q2+Q3
PcΣ	[W]	Pc1+Pc2			Pc1+Pc2+Pc3
WPΣ	[Wh]	WP1+WP2			WP1+WP2+WP3
WP+Σ	[Wh]	WP+1+WP+2			WP+1+WP+2+WP+3
WP-Σ	[Wh]	WP-1+WP-2			WP-1+WP-2+WP-3
qΣ	[Ah]	q1+q2			q1+q2+q3
q+Σ	[Ah]	q+1+q+2			q+1+q+2+q+3
q-Σ	[Ah]	q-1+q-2			q-1+q-2+q-3
WQΣ	[varh]	$\frac{1}{N} \sum_{n=1}^N Q\Sigma(n) \times \text{Time}$ QΣ(n) is the nth reactive power Σ function, and N is the number of data updates.			
WSΣ	[VAh]	$\frac{1}{N} \sum_{n=1}^N S\Sigma(n) \times \text{Time}$ SΣ(n) is the nth apparent power Σ function, and N is the number of data updates.			
λΣ		$\frac{P\Sigma}{S\Sigma}$			
∅Σ	[°]	$\cos^{-1} \left(\frac{P\Sigma}{S\Sigma} \right)$			

- Note 1) The instrument's apparent power (S), reactive power (Q), power factor (I), and phase angle (∅) are calculated using measured values of voltage, current, and active power. (However, reactive power is calculated directly from sampled data when TYPE3 is selected.) Therefore, when distorted waveforms are input, these values may be different from those of other measuring instruments based on different measuring principals.
- Note 2) The value of Q in the QS calculation is calculated with a preceding minus sign (-) when the current input leads the voltage input, and a plus sign when it lags the voltage input, so the value of QS may be negative.

η [%]	Set a efficiency calculation up to 4
User-defined functions F1-F20	Create equations combining measurement function symbols, and calculate up to twenty numerical data.

Waveform Display (WAVE display)

Waveform display items	Voltage and current from elements 1 through 4 Motor version torque and waveform of revolution speed
------------------------	--

Accuracy

	Voltage/current	Power
[Conditions]	DC: 0.05% of reading+0.05% of range 0.1Hz<f<30Hz	DC: 0.05% of reading+0.1% of range 0.1Hz<f<30Hz
Temperature: 23±5°C	0.1% of reading+0.2% of range	0.2% of reading+0.3% of range
Humidity: 30 to 75%RH	30Hz<f<45Hz	30Hz<f<45Hz
Input waveform:	0.03% of reading+0.05% of range	0.05% of reading+0.05% of range
Sine wave	45Hz<f<66Hz	45Hz<f<66Hz
Common mode voltage:	0.01% of reading+0.03% of range	0.02% of reading+0.04% of range
0 V	66Hz<f<1kHz	66Hz<f<1kHz
Crest factor: 3	0.03% of reading+0.05% of range	0.05% of reading+0.05% of range
Line filter: OFF	1kHz<f<10kHz	1kHz<f<10kHz
λ (power factor): 1	0.1% of reading+0.05% of range	0.15% of reading+0.1% of range
After warm-up:	10kHz<f<50kHz	10kHz<f<50kHz
After zero level	0.3% of reading+0.1% of range	0.3% of reading+0.2% of range
compensation or range value change while	50kHz<f<100kHz	50kHz<f<100kHz
wired.	0.012×f% of reading+0.2% of range	0.014×f% of reading+0.3% of range
f is frequency	100kHz<f<500kHz	100kHz<f<500kHz
6-month after calibration	0.009×f% of reading+0.5% of range	0.012×f% of reading+1% of range
* These conditions are all accuracy condition in this section.	500kHz<f<1MHz	500kHz<f<1MHz
	(0.022×f-7)% of reading+1% of range	0.048×f-19)% of reading+2% of range

- The units of f in the reading error equation are kHz.
- Accuracy of waveform display data, Upk and Ipk
Add 3% of range to the accuracy above. However, add 3% of range +5mV for external input (reference value). Effective input range is within ±300%
- Influenced by changes in temperature after zero level correction or range value changes.
Add 50ppm of range/°C to the voltage DC accuracy, 0.2 mA/°C to the current DC accuracy, 0.02 mV/°C to the external current DC accuracy, and influence of voltage times influence of current to the power DC accuracy.
- Influence of self heating due to current input
When the input signal is current, add 0.00002 x I²% of rdg, and for DC add 0.00002 x I²% of rdg + 0.003 x I²mA to the current and power accuracy. I is the reading value of current (A). Please note that the influence of self-heating is present until the shunt resistance temperature drops, even when the current input value is small.
- Additions to accuracy according to the data update rate
Add 0.05% of rdg when it is 100 ms, and 0.1% of rdg when 50ms.
- Range of guaranteed accuracy by frequency, voltage, and current
All accuracies between 0.1 Hz and 10 Hz are reference values.
If the voltage exceeds 750 V at 30 kHz-100 kHz, or exceeds (2.2 x 10¹¹/f(kHz))V at 100 kHz-1 MHz, the voltage and power values are reference values.
If the current exceeds 20 A at DC, 10 Hz-45Hz, or 400 Hz-200 kHz; or if it exceeds 10 A at 200 kHz-500 kHz; or exceeds 5 A at 500 kHz-1 MHz, the current and power accuracies are reference values.
- Accuracy for crest factor 6: Range accuracy of crest factor 3 for two times range of crest factor 6.

Precision Power Analyzer WT3000

	Voltage/current	Power
Influence of power factor (λ)	—	When $\lambda=0$ Apparent power reading $\times 0.03\%$ in the 45 to 66 Hz range All other frequencies are as follows (however, these are only reference values): Apparent power reading \times ($0.03+0.05 \times f(\text{kHz})$)% When $0 < \lambda < 1$ Add power reading \times ($\tan\theta \times$ (effect when $\lambda = 0$))%. However, θ is the phase angle of voltage and current.
Influence of line filter	When cutoff frequency is 500 Hz *45 to 66Hz: Add 0.2% of reading Under 45 Hz: Add 0.5% of reading* When cutoff frequency is 5.5 kHz *66Hz or less: Add 0.2% of reading 66 to 500Hz: Add 0.5% of reading* When cutoff frequency is 50 kHz *500Hz or less: Add 0.2% of reading 500 to 5kHz: Add 0.5% of reading*	When cutoff frequency is 500 Hz *45 to 66Hz: Add 0.3% of reading Under 45 Hz: Add 1% of reading* When cutoff frequency is 5.5 kHz *66Hz or less: Add 0.3% of reading 66 to 500Hz: Add 1% of reading* When cutoff frequency is 50 kHz *500Hz or less: Add 0.3% of reading 500 to 5kHz: Add 1% of reading*
Lead/Lag Detection (d (LEAD)/G (LAG) of the phase angle and symbols for the reactive power Q Σ calculation) * The s symbol shows the lead/lag of each element, and "-" indicates leading.	The phase lead and lag are detected correctly when the voltage and current signals are both sine waves, the lead/lag is 50% of the range rating (or 100% for crest factor 6), the frequency is between 20 Hz and 10 kHz, and the phase angle is $\pm (5^\circ \text{ to } 175^\circ)$ or more.	
Temperature coefficient	$\pm 0.02\%$ of reading/°C at 5–18° or 28–40 °C.	
Effective input range	Udc and Idc are 0 to $\pm 130\%$ of the measurement range Urms and Irms are 1 to 130% * of the measurement range (or 2%–130% for crest factor 6) Umn and Imn are 10 to $\pm 130\%$ of the measurement range Urmn and Irmn are 10 to $\pm 130\%$ * of the measurement range Power is 0 to $\pm 130\%$ * for DC measurement, 1 to 130% * of the voltage and current range for AC measurement, and up to $\pm 130\%$ * of the power range. However, when the data update rate is 50 ms, 100 ms, 5 sec, 10 sec, or 20 sec, the synchronization source level falls below the input signal of frequency measurement. 140% of the voltage and current range rating. The accuracy at 110 to 130% of the measurement range is the reading error $\times 1.5$.	
Max. display	140% of the voltage and current range rating	
Min. display	Urms and Irms are up to 0.3% relative to the measurement range (or up to 0.6% for a crest factor of 6). Umn, Urmn, Imn, and Irmn are up to 1% (or 2% for a crest factor of 6). Below that, zero suppress. Current integration value q also depends on the current value.	
Measurement lower limit frequency	Data update rate	50ms 100ms 250ms 500ms 1s 2s 5s 10s 20s
Accuracy of apparent power S (reference value)	Measurement lower limit frequency	45Hz 25Hz 20Hz 10Hz 5Hz 2Hz 0.5Hz 0.2Hz 0.1Hz
Accuracy of reactive power Q (reference value)	Voltage accuracy + current accuracy	
Accuracy of power factor λ (reference value)	Accuracy of apparent power $+\sqrt{(1.0004-\lambda^2)} - \sqrt{(1-\lambda^2)}$ % of range	
Accuracy of phase difference θ (reference value)	$\pm [(\lambda-1/1.0002) + \cos\theta - \cos(\theta + \sin^{-1}(\text{influence of power factor of power when } \lambda=0\% / 100))] \pm 1 \text{ digit}$ θ is the phase difference of voltage and current.	
One-year accuracy	$\pm [\theta - \cos^{-1}(\lambda/1.0002) + \sin^{-1}(\text{influence of power factor of power when } \lambda=0\% / 100)] \text{ deg } \lambda 1 \text{ digit}$	
One-year accuracy	Add the accuracy of reading error (Six-month after calibration) $\times 0.5$ to the accuracy six-month after calibration	

Functions

Measurement method	Digital multiplication method
Crest factor	3 or 6 (when inputting rated values of the measurement range), and 300 relative to the minimum valid input. However, 1.6 or 3.2 at the maximum range (when inputting rated values of the measurement range), and 160 relative to the minimum valid input.
Measurement interval	Interval for determining the measurement function and performing calculations. • When data update rate is 50 ms, 100 ms, 10 s, or 20 s. Excluding amount of current q given amount of energy Wp and when in DC mode, the measurement interval is set at the zero cross of the reference signal (synchronization source). • When data update rate is 250 ms, 500 ms, 1 s, or 2 s Measured using the exponential average relative to the sampling data within the data update rate. • When using harmonic display (required/G5 option) The selected FFT data length is the measurement interval.
Wiring	You can select one of the following five wiring settings. 1P2W (single phase, two-wire), 1P3W (single phase, 3 wire), 3P3W (3 phase, 3 wire), 3P4W (3 phase, 4 wire), 3P3W(3V3A) (3 phase, 3 wire, 3 volt/3 amp measurement). However, the number of available wiring settings varies depending on the number of installed input elements. Up to four, or only one, two, or three wiring settings may be available.
Compensation Functions	• Efficiency Compensation Compensation of instrument loss during efficiency calculation • Wiring Compensation Compensation of instrument loss due to wiring • 2 Wattmeter Method Compensation Compensation for 2 wattmeter method
Scaling	When inputting output from external current sensors, VT, or CT, set the current sensor conversion ratio, VT ratio, CT ratio, and power coefficient in the range from 0.0001 to 99999.9999.
Input filter	Line filter or frequency filter settings can be entered.

Averaging

• The average calculations below are performed on the normal measurement parameters of voltage U, current I, power P, apparent power S, reactive power Q. Power factor λ and phase angle θ are determined by calculating the average of P and S.

- Select exponential or moving averaging.
- Exponential average
Select an attenuation constant of 2, 4, 8, 16, 32, or 64.
- Moving average
Select the number of averages from 8, 16, 32, 64, 128, or 256.
- The average calculations below are performed on the harmonic display items of voltage U, current I, power P, apparent power S, reactive power Q. Power factor λ is determined by calculating the average of P and Q. Only exponential averaging is performed. Select an attenuation constant of 2, 4, 8, 16, 32 or 64

Data update rate

Select 50 ms, 100 ms, 250 ms, 500 ms, 1 s, 2 s, 5 s, 10 s, or 20 s. However, when the data update rate is 50 ms or 100 ms the display update rate is 250 ms.

Response time

At maximum, two times the data update rate (only during numerical display)
Holds the data display.
Executes a single measurement during measurement hold.
Zero level compensation/Null Compensates the zero level.

Hold

Single

Zero level compensation/Null

Integration

Mode

Select a mode of Manual, Standard, Continuous (repeat), Real Time Control Standard, or Real Time Control Continuous (Repeat).

Timer

Integration can be stopped automatically using the integration timer setting. 0000h00m00s–1000h00m00s

Count over

If the count over integration time reaches the maximum integration time (10000 hours), or if the integration value reaches max/min display integration value (± 999999 MWh or ± 999999 Mah), the elapsed time and value is saved and the operation is stopped.

Accuracy

\pm (power and current accuracy + time accuracy)

Time accuracy

0.02% of reading

Display

• Numerical display function

Display resolution 600000

Number of display items Select 4, 8, 16, all, single list, or dual list.

• Waveform display items

No. of display rasters 501

Display format Peak-peak compressed data

Time axis Range from 0.5 ms–2 s/div. However, it must be 1/10th of the data update rate.

Triggers

Trigger Type

Edge type

Trigger Mode

Select Auto or Normal. Triggers are turned OFF automatically during integration.

Trigger Source

Select voltage, current, or external clock for the input to each input element.

Trigger Slope

Select (Rising), (Falling), or (Rising/Falling).

Trigger Level

When the trigger source is the voltage or current input to the input elements. Set in the range from the center of the screen to $\pm 100\%$ (top/bottom edge of the screen). Setting resolution: 0.1%

When the trigger source is Ext Clk, TTL level.

Vertical axis Zoom

Voltage and current input to the waveform vertical axis zoom input element can be zoomed along the vertical axis.

Set in the range of 0.1 to 100 times.

ON/OFF

ON/OFF can be set for each voltage and current input to the input element.

Format

You can select 1, 2, 3 or 4 splits for the waveform display.

Interpolation

Select dot or linear interpolation.

Other display ON/OFF

Select graticule or cross-grid display.

Cursor measurements

Upper/lower limit (scale value), and waveform label ON/OFF. When you place the cursor on the waveform, the value of that point is measured.

Zoom function

No time axis zoom function

* Since the sampling frequency is approximately 200 kHz, waveforms that can be accurately reproduced are those of about 10 kHz.

• Vector Display/Bar Graph Display

Vector display

Vector display of the phase difference in the fundamental waves of voltage and current.

Bar graph display

Displays the size of each harmonic in a bar graph.

• Trend display

Number of measurement channels Up to 16 parameters

Displays trends (transitions) in numerical data of the measurement functions in a sequential line graph.

• Simultaneous display

Two windows can be selected (from numerical display, waveform display, bar graph display, or trend display) and displayed in the upper and lower parts of the screen.

• Saving and Loading Data

Settings, waveform display data, numerical data, and screen image data can be saved to media.
Saved settings can be loaded from a medium.

Motor Evaluation Function (-MV, Motor Version)

Measurement Function	Method of Determination/Equation
Speed	Method of Determination/Equation When the input signal from the revolution sensor is DC voltage (analog signal) Input voltage from revolution sensor x scaling factor Scaling factor: Number of revolutions per 1 V input voltage When the input signal from the revolution sensor is number of pulses $\frac{\text{Number of input pulses/minute from revolution sensor}}{\text{No. of pulses/revolution}} \times \text{Scaling factor}$
Torque	When the type of input signal from the torque meter is DC voltage (analog signal) Input voltage from torque meter x scaling factor Scaling factor: Torque per 1 V input voltage When the type of input signal from the torque is number of pulses Enter N-m equivalent to upper- and lower-limit frequencies to determine an inclination from these two frequencies, and then multiply the number of pulses.
SyncSp	$\frac{120 \times \text{freq. of the freq. meas. source}}{\text{no. of poles of the motor}}$
Slip[%]	$\frac{\text{SyncSp} - \text{Speed}}{\text{SyncSp}} \times 100$
Motor output Pm	$\frac{2\pi \times \text{Speed} \times \text{Torque}}{60} \times \text{scaling factor}$

Revolution signal, torque signal

- When revolution and torque signals are DC voltage (analog input)
 - Connector type: Insulated BNC connector
 - Input range: 1 V, 2 V, 5 V, 10 V, 20 V
 - Effective input range: 0% to ±110% of measurement range
 - Input resistance: Approximately 1 MΩ
 - Continuous maximum allowed input voltage: ±22 V
 - Continuous maximum common mode voltage: ±42 V_{peak} or less
 - Accuracy: ±(0.1% of reading + 0.1% of range)
 - Temperature coefficient: ±0.03% of range/°C
- When revolution and torque signals are pulse input
 - Connector type: Insulated BNC connector
 - Frequency range: 2 Hz–200 kHz
 - Amplitude input range: ±5 V_{peak}
 - Effective amplitude: 1 V (peak-to-peak) or less
 - Input waveform duty ratio: 50%, square wave
 - Input resistance: Approximately 1 MΩ
 - Continuous maximum common mode voltage: ±42 V_{peak} or less
 - Accuracy: ±(0.05% of reading + 1 mHz)

Added Frequency Measurement (/FQ Optional)

Device under measurement	Select up to two frequencies of the voltage or current input to the input elements for measurement. If the frequency option (/FQ) is installed, the frequencies of the voltages and currents being input to all input elements can be measured.																				
Measurement method	Reciprocal method																				
Measurement range	<table border="1"> <thead> <tr> <th>Data Update Rate</th> <th>Measuring Range</th> </tr> </thead> <tbody> <tr> <td>50ms</td> <td>45Hz≤f≤1MHz</td> </tr> <tr> <td>100ms</td> <td>25Hz≤f≤1MHz</td> </tr> <tr> <td>250ms</td> <td>10Hz≤f≤500kHz</td> </tr> <tr> <td>500ms</td> <td>5Hz≤f≤200kHz</td> </tr> <tr> <td>1s</td> <td>2.5Hz≤f≤100kHz</td> </tr> <tr> <td>2s</td> <td>1.5Hz≤f≤50kHz</td> </tr> <tr> <td>5s</td> <td>0.5Hz≤f≤20kHz</td> </tr> <tr> <td>10s</td> <td>0.25Hz≤f≤10kHz</td> </tr> <tr> <td>20s</td> <td>0.15Hz≤f≤5kHz</td> </tr> </tbody> </table>	Data Update Rate	Measuring Range	50ms	45Hz≤f≤1MHz	100ms	25Hz≤f≤1MHz	250ms	10Hz≤f≤500kHz	500ms	5Hz≤f≤200kHz	1s	2.5Hz≤f≤100kHz	2s	1.5Hz≤f≤50kHz	5s	0.5Hz≤f≤20kHz	10s	0.25Hz≤f≤10kHz	20s	0.15Hz≤f≤5kHz
Data Update Rate	Measuring Range																				
50ms	45Hz≤f≤1MHz																				
100ms	25Hz≤f≤1MHz																				
250ms	10Hz≤f≤500kHz																				
500ms	5Hz≤f≤200kHz																				
1s	2.5Hz≤f≤100kHz																				
2s	1.5Hz≤f≤50kHz																				
5s	0.5Hz≤f≤20kHz																				
10s	0.25Hz≤f≤10kHz																				
20s	0.15Hz≤f≤5kHz																				
Accuracy	±0.05% of reading When the input signal levels are greater than or equal to 25 mV (current external sensor input) and 150 mA (current direct input) respectively, and the signal is greater than or equal to 30% (0.1 Hz–440 Hz, frequency filter ON), 10% (440 Hz–500 kHz), or 30% (500 kHz–1 MHz) of the measurement range. However, when the measuring frequency is smaller or equal to 2 times of above lower frequency, the input signal is greater than or equal to 50%. Add 0.05% of reading when current external input is smaller than or equal to 50 mV input signal level for each is double for crest factor 6.																				

Delta Calculation Function (/DT Optional)

Item	Delta Calculation Setting	Symbols and Meanings
Voltage	Udiff, Idiff	Calculated differential voltage and current
Current	3P3W→3V3A	Line to line voltage and phase current are determined in the calculation for a 3 phase 3 wire connection
	DELTA→STAR	Phase voltage and neutral current are determined in the calculation for 3 phase 3 wire (3V3A) connection
	STAR→DELTA	Line to line voltage and neutral current determined in the calculation for a 3 phase 4 wire connection

Harmonic Measurement Function (/G5 Optional)

Device under Measurement	All Installed Elements
Method	PLL synchronization
Frequency range	PLL source of the fundamental frequency is in the range 10 Hz–440 Hz.
PLL source	Select voltage, current, or external clock for each input element.
Word length for FFT	32 bits
Window function	Rectangular
Anti-aliasing filter	Set using a line filter (5.5 kHz or 50 kHz)

Sample rate (sampling frequency), window width, and upper limit of analyzed orders for PLL synchronization.

During Harmonic Display

Fundamental Frequency	Sample Rate	Window Width	Upper Limit of Analyzed orders
10Hz to 20Hz	f*3000	3	100
20Hz to 40Hz	f*1500	6	100
40Hz to 55Hz	f*900	10	100
55Hz to 75Hz	f*750	12	100
75Hz to 150Hz	f*450	20	50
150Hz to 440Hz	f*150	75	15

Accuracy ±(reading error + measurement range error)

When Line Filter is ON (5.5 kHz)

Sampling Frequency	Voltage Current	Power
10Hz≤f<30Hz	0.25% of reading+0.3% of range	0.5% of reading+0.4% of range
30Hz≤f≤66Hz	0.2% of reading+0.15% of range	0.4% of reading+0.15% of range
66Hz≤f≤440Hz	0.5% of reading+0.15% of range	1.2% of reading+0.15% of range
440Hz≤f≤1kHz	1.2% of reading+0.15% of range	2% of reading+0.15% of range
1kHz≤f≤2.5kHz	2.5% of reading+0.15% of range	6% of reading+0.2% of range

- Power exceeding 440 Hz is a reference value.
- During nth order component input, add (nth order reading) of (n/(m+1))/50% to the (n+m)th order and (n-m)th order.
- Add (n/500)% of reading to nth order components

When Line Filter is ON (5.5 kHz)

Sampling Frequency	Voltage Current	Power
10Hz≤f<30Hz	0.25% of reading+0.3% of range	0.45% of reading+0.4% of range
30Hz≤f≤440Hz	0.2% of reading+0.15% of range	0.4% of reading+0.15% of range
440Hz≤f≤2.5kHz	1% of reading+0.15% of range	2% of reading+0.2% of range
2.5kHz≤f≤5kHz	2% of reading+0.15% of range	4% of reading+0.2% of range
5kHz≤f≤7.5kHz	3.5% of reading+0.15% of range	6.5% of reading+0.2% of range

- Power exceeding 440 Hz is a reference value.
- During nth order component input, add (nth order reading) of (n/(m+1))/50% to the (n+m)th order and (n-m)th order.
- Add (n/500)% of reading to nth order components

When Line Filter is OFF

Sampling Frequency	Voltage Current	Power
10Hz≤f<30Hz	0.15% of reading+0.3% of range	0.25% of reading+0.4% of range
30Hz≤f≤440Hz	0.1% of reading+0.15% of range	0.2% of reading+0.15% of range
440Hz≤f≤2.5kHz	0.6% of reading+0.15% of range	1.2% of reading+0.2% of range
2.5kHz≤f≤5kHz	1.6% of reading+0.15% of range	3.2% of reading+0.2% of range
5kHz≤f≤7.5kHz	2.5% of reading+0.15% of range	5% of reading+0.2% of range

- Power exceeding 440 Hz is a reference value.
- During nth order component input, add (nth order reading) of (n/(m+1))/50% to the (n+m)th order and (n-m)th order.
- Add (n/500)% of reading to nth order components

D/A Output (/DA Optional)

D/A conversion resolution	16 bits
Response time	At maximum, two times the data update rate.
Output voltage	±5 V FS (max. approximately ±7.5 V) for each rated value
Update rate	Same as the data update rate on the main unit. However, select 10 ms or 20 ms during high speed D/A output. The maximum response time is up to two times the display update rate plus 10 ms.
Number of outputs	20 channels (each channel can be set separately)
Accuracy	± (accuracy of a given measurement function + 0.1% of FS) FS = 5V
Minimum load	100 kΩ
Temperature coefficient	±0.05% of FS/°C

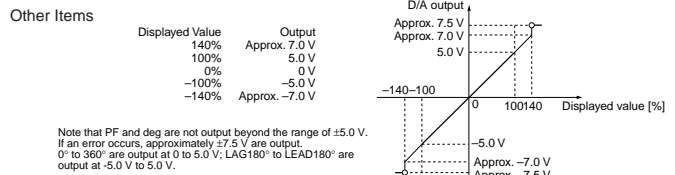
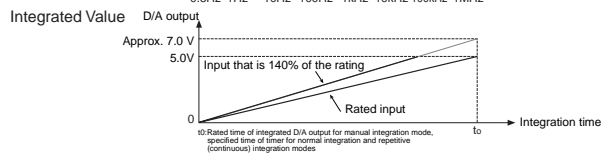
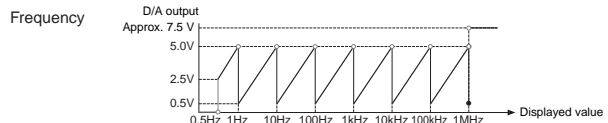

Built-in Printer (/B5 Optional)

Printing method	Thermal line-dot
Dot density	8 dots/mm
Paper width	112 mm
Effective recording width	104 mm
Recorded information	Screenshots, list of measured values, harmonic bar graph printouts, settings

Precision Power Analyzer WT3000

Serial (RS-232) Interface (/C2 Optional)

Connector type	9-pin D-Sub (plug)
Electrical specifications	Conforms with EIA-574 (EIA-232 (RS-232) standard for 9-pin)
Connection type	Point-to-point
Communication mode	Full duplex
Synchronization method	Start-stop synchronization
Baud rate	Select from the following. 1200,2400,4800,9600,19200 bps

RGB Video Signal (VGA) Output Section (/V1 Optional)

Connector type	15-pin D-Sub (receptacle)
Output format	VGA compatible

Ethernet Communications (/C7 Optional) Sales announcement

Number of communication ports	1
Connector type	RJ-45 connector
Electrical and mechanical specifications	Conforms to IEEE 802.3.
Transmission system	Ethernet 100BASE—TX/10BASE-T
Transmission rate	10 Mbps
Protocol	TCP/IP
FTP Client	Settings, waveform display data, numerical data, and screen image data can be saved to an FTP server on the network. You can load settings saved on an FTP server. You can access the instrument from a PC or workstation residing on the same network as the FTP server, and download files from the instrument's PCMCIA card. However, the PC or workstation must be running FTP client software. Screen images can be print to a network printer.
LPR client	Data from the instrument can be transmitted periodically to an e-mail message specified as the SMTP client.
SMTP client	

External I/O

I/O Section for Master/Slave Synchronization Signals

Connector type	BNC connector: Both slave and master
I/O level	TTL: Same for both slave and master
Output logic	Negative logic, falling edge: Applies to master
Measurement start delay time	Within (1 μ s + 1 sample rate): Applies to master
Output hold time	Low level, 500 ns or less: Applies to master
Input logic	Negative logic, falling edge: Applies to slave
Minimum pulse width	Low level, 500 ns or less: Applies to slave
Input delay time	Within (1 μ s + 1 sample rate): Applies to slave

External Clock Input Section

Connector type	BNC connector
Input level	TTL
Inputting the synchronization source as the Ext Clk of normal measurement.	Same as the measurement range for frequency measurement.
Frequency range	50% duty ratio square wave
Input waveform	50% duty ratio square wave
Inputting the PLL source as the Ext Clk of harmonic measurement.	
Frequency range	10 Hz to 2.5 kHz
Input waveform	50% duty ratio square wave

For Triggers

Minimum pulse width	1 μ s
Trigger delay time	Within (1 μ s + 1 sample rate)

PC Card Interface

TYPE II (Flash ATA card)

GP-IB Interface

Use one of the following by NATIONAL INSTRUMENTS:

- AT-GPIB
 - PCI-GPIB and PCI-GPIB+
 - PCMCIA-GPIB and PCMCIA-GPIB+
- Use driver NI-488.2M version 1.60 or later.
Conforms electrically and mechanically to IEEE St'd 488-1978 (JIS C 1901-1987).
Functional specification SH1, AH1, T6, L4, SR1, RL1, PP0, DC1, DT1, and C0.

Encoding	ISO (ASCII)
Mode	Addressable mode
Address	0–30
Clear remote mode	Remote mode can be cleared using the LOCAL key (except during Local Lockout).

General Specifications

Warm-up time	Approximately thirty minutes.
Operating temperature:	5–40°C
Operating humidity:	20–80% (when printer not used), 35 to 80% RH (when printer is used) (No condensation may be present)
Operating altitude	2000 m or less
Storage environment:	-25–60°C (no condensation may be present)
Storage humidity:	20 to 80% RH (no condensation)
Rated supply voltage	100–240 VAC
Allowed supply voltage fluctuation range	90–264 VAC
Rated supply frequency	50/60 Hz
Allowed supply frequency fluctuation	48 to 63 Hz
Maximum power consumption	150 VA (when using built-in printer)
Weight	Approximately 15 kg (including main unit, 4 input elements, and options)
Battery backup	Setup information and internal clock are backed up with the lithium battery

DESCRIPTION

Automatically select the appropriate calculation for each data updating period

AC signals have waveforms that fluctuate repeatedly when viewed instantaneously. Therefore, measuring the power values of AC signals requires averaging for each period in a repeated interval, or averaging the data of several periods using a filtering process. The WT3000 automatically selects the appropriate calculation method (one of the above two methods) based on the data updating period. This approach ensures fast response and high stability as suitable for the particular measurement objective.

- **When the data updating period is 50ms, 100ms, 5s, 10s, or 20s**

Measurement values are determined by applying an Average for the Synchronous Source Period (ASSP) calculation to the sample data within the data updating period. (Note that this excludes power integrated values WP, as well as current integrated value q in DC mode). With ASSP, a frequency measurement circuit is used to detect the input signal period set as the synchronous source. Sample data corresponding to an interval which is an integer multiple of the input period are used to perform the calculation. Based on its fundamental principles, the ASSP method allows measurement values to be obtained simply by averaging an interval corresponding to a single period, so it is useful in cases where the

data updating period is short or when measuring the efficiency of low-frequency signals. This method will not provide correct measurement values unless the period of the set synchronous source signal is accurately sensed. Therefore, it is necessary to check whether the frequency of the synchronous source signal has been accurately measured and displayed. See the user's manual for notes on the synchronous source signal and frequency filter settings.

- **When the data updating period is 250ms, 500ms, 1s, or 2s**

Measurement values are determined by applying an Exponential Average for Measuring Period (EAMP) calculation to the sample data within the data updating period. With EAMP, the sample data are averaged by applying a digital filtering process. This method does not require accurate detection of the input period. EAMP provides excellent measurement value stability.

* See page 12 of the specifications for information on the relationship between the data updating period and the lowest measurement frequency.

Selecting formulas for calculating apparent power and reactive power

There are several types of power—active power, reactive power, and apparent power. Generally, the following equations are satisfied:

Active power $P = UI\cos\phi$ (1)

Reactive power $Q = UI\sin\phi$ (2)

Apparent power $S = UI$ (3)

In addition, these power values are related to each other as follows:

(Apparent power S)² = (Active power P)² + (Reactive power Q)² (4)

U: Voltage RMS

I: Current RMS

ϕ : Phase between current and voltage

Three-phase power is the sum of the power values in the individual phases.

These defining equations are only valid for sinewaves. In recent years, there has been an increase in measurements of distorted waveforms, and users are measuring sinewave signals less frequently. Distorted waveform measurements provide different measurement values for apparent power and reactive power depending on which of the above defining equations is selected. In addition, because there is no defining equation for power in a distorted wave, it is not necessarily clear which equation is correct. Therefore, three different formulas for calculating apparent power and reactive power are provided with the WT3000.

- **TYPE1 (method used in normal mode with older WT Series models)**

With this method, the apparent power for each phase is calculated from equation (3), and reactive power for each phase is calculated from equation (2). Next, the results are added to calculate the power.

Active power for three-phase four-wire connection: $P\Sigma = P1 + P2 + P3$

Apparent power for three-phase four-wire connection: $S\Sigma = S1 + S2 + S3 (= U1 \times I1 + U2 \times I2 + U3 \times I3)$

Reactive power for three-phase four-wire connection: $Q\Sigma = Q1 + Q2 + Q3$

(= $\sqrt{(U1 \times I1)^2 - P1^2} + \sqrt{(U2 \times I2)^2 - P2^2} + \sqrt{(U3 \times I3)^2 - P3^2}$)

*S1, S2, and S3 are calculated with a positive sign for the leading phase and a negative sign for the lagging phase.

- **TYPE2**

The apparent power for each phase is calculated from equation (3), and the results are added together to calculate the three-phase apparent power (same as in TYPE1). Three-phase reactive power is calculated from the three-phase apparent power and three-phase active power using equation (4).

Active power for three-phase four-wire connection: $P\Sigma = P1 + P2 + P3$

Apparent power for three-phase four-wire connection: $S\Sigma = S1 + S2 + S3 (= U1 \times I1 + U2 \times I2 + U3 \times I3)$

Reactive power for three-phase four-wire connection: $Q\Sigma = \sqrt{S\Sigma^2 - P\Sigma^2}$

- **TYPE3 (method used in harmonic measurement mode with WT1600 and PZ4000)**

This is the only method in which the reactive power for each phase is directly calculated using equation (2). Three-phase apparent power is calculated from equation (4).

Active power for three-phase four-wire connection: $P\Sigma = P1 + P2 + P3$

Apparent power for three-phase four-wire connection: $S\Sigma = \sqrt{P\Sigma^2 + Q\Sigma^2}$

Reactive power for three-phase four-wire connection: $Q\Sigma = Q1 + Q2 + Q3$

Accessories

Instrument Carts.



701960

Compact Instrument Cart

500 × 560 × 705 mm (WDH)
/A: Keyboard and mouse mount

Top shelf	Equipment not exceeding 450 (W) × 450 (D) × 300 (H) mm
Middle shelf	Equipment not exceeding 450 (W) × 450 (D) × 300 (H) mm
Bottom shelf	Equipment not exceeding 450 (W) × 450 (D) × 240 (H) mm

* W: Width D: Depth H: Height
Maximum load: 20 kg on each shelf



701961

Deluxe Instrument Cart

570 × 580 × 839 mm (WDH)
/A: Keyboard and mouse mount

Top shelf	Equipment not exceeding 450 (W) × 450 (D) × 400 (H) mm
Bottom shelf	Equipment not exceeding 450 (W) × 450 (D) × 400 (H) mm

* W: Width D: Depth H: Height
Maximum load: 50 kg on each shelf
*The photo shows the mount holding a DL7400.

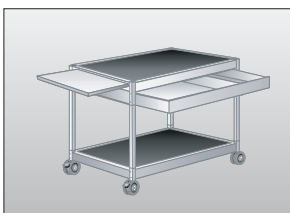

701962

All-purpose Instrument Cart

467 × 693 × 713 mm (WDH)

Top shelf	Equipment not exceeding 457 (W) × 683 (D) mm
Drawer	Equipment not exceeding 610 (W) × 380 (D) mm
Slide table	Equipment not exceeding 380 (W) × 440 (D) mm

* W: Width D: Depth
Maximum load: 50 kg on each shelf

External dimensions of Yokogawa power meters (excluding protrusions)

	Width (mm)	Height (mm)	Depth (mm)	Compact mount 701960	Deluxe mount 701961	General-purpose mount 701962
WT3000	426	177	450	✓	✓	✓
WT1600	426	177	400	✓	✓	✓
WT210	213	88	379	✓	✓	✓
WT230	213	132	379	✓	✓	✓
PZ4000	426	177	450	✓*1	✓*1	✓*1

*1 The back-side inputs protrude beyond the back shelves of the mounts.

* These mount do not conform to CE marking.

WT Series & PZ



WT1600

This model has a wide range of display capabilities, including waveforms and vectors, and features suitable for a wide variety of applications.



WT210

The WT210 is a low-priced model which can independently measure standby power consumption and rated power.



PZ4000 Power Analyzer

This analyzer has wide frequency range and waveform analysis functions.



WT230

The WT230 is a small three-phase model with an optional harmonic measurement function.

* See the individual product catalogs for details.

Model and Suffix Codes

Precision Power Analyzer WT3000

Model	Suffix Codes	Description
760301		WT3000 1 input element model
760302		WT3000 2 input elements model
760303		WT3000 3 input elements model
760304		WT3000 4 input elements model
Element number	-01	Select when you selected 760301 model
	-02	Select when you selected 760302 model
	-03	Select when you selected 760303 model
	-04	Select when you selected 760304 model
Version	-SV	Standard Version
	-MV	Motor Version
Power cord	-D	UL/CSA standard
	-F	VDE standard
	-R	AS standard
	-Q	BS standard
	-H	GB standard
Options	/G5	Harmonic Measurement
	/B5	Built-in Printer
	/DT	Delta Calculation
	/FQ	Add-on Frequency Measurement
	/DA	20ch D/A output
	/V1	VGA Output
	/C2	Serial (RS-232) Interface
/C7	Ethernet function (planned for release)	

Note: Adding input modules after initial product delivery will require rework at the factory. Please choose your models and configurations carefully, and inquire with your sales representative if you have any questions.

Standard accessories

Power cord, Spare power fuse, Rubber feet, current input protective cover, User's manual, expanded user's manual, communication interface user's manual, printer roll paper (provided only with /B5), connector (provided only with /DA) Safety terminal adapter 758931 (provided two adapters in a set times input element number)

Safety terminal adapter 758931



* Cable B9284LK (light blue) for external current sensor input is sold separately. Safety terminal adapter 758931 is included with the WT3000. Other cables and adapters must be purchased by the user.

Rack Mount

Model	Product	Description
751535-E4	Rack mounting kit	For EIA
751535-J4	Rack mounting kit	For JIS

Accessory (sold separately)

Model/parts number	Product	Description	Order Q'ty
758917	Test read set	A set of 0.8m long, red and black test	1
758922	Small alligator-clip	Rated at 300V and used in a pair	1
758929	Large alligator-clip	Rated at 1000V and used in a pair	1
758923	Safety terminal adapter	(spring-hold type) Two adapters to a set.	1
758931	Safety terminal adapter	(screw-fastened type) Two adapters to a set. 1.5 mm hex Wrench is attached	1
758924	Conversion adapter	BNC-banana-jack(female) adapter	1
366924	BNC-BNC cable	1m	1
366925	BNC-BNC cable	2m	1
758921	Fork terminal adapter	Banana-fork adapter. Two adapters to a set	1
B9284LK	External sensor cable	Current sensor input connector. Length 0.5m	1
B9316FX	Printer roll paper	Thermal paper, 10 meters (1 roll)	10

▲ Due to the nature of this product, it is possible to touch its metal parts. Therefore, there is a risk of electric shock, so the product must be used with caution.

* Use these products with low-voltage circuits (42V or less).

Mounts

Model	Suffix and codes	Description	Description
701960		Compact mount	500*560*705mm(W, D, H)
	/A		Key board and mouse table
701961		Deluxe mount	570*580*839mm(W, D, H)
	/A		Key board and mouse table
701962		General-purpose mount	467*693*713mm(W, H, D)

Current Sensor Unit

Model	Suffix code	Description	Description
751521		Single-phase	DC to 100 kHz (-3 dB), -600 A to 0 A to +600 A (DC)
751523	-10	Three-phase U, V	Basic accuracy: ±(0.05% of rdg* + 40 mA) Superior noise withstanding ability and CMRR characteristic due to optimized casing design
	-20	Three-phase U, W	
	-30	Three-phase U, V, W	
Supply voltage	-1	100 V AC (50/60 Hz)	
	-3	115 V AC (50/60 Hz)	
	-7	230 V AC (50/60 Hz)	
Power card	-D	UL/CSA standard	
	-F	VDE standard	
	-R	SAA standard	
	-J	BS standard	
	-H	GB standard	

* 751523-10 is designed for WT3000, PZ4000 and WT1600. 751523-20 is designed for the WT2000, and WT200 Series.

* 751521/751523 do not conform to CE Marking.

Clamp on Probe / Current transducer

Model	Product	Description
96001	Clamp-on probe	20 Hz to 20 kHz, 600Apk (400 Arms)
751552	Clamp-on probe	30 Hz to 5 kHz, 1400Apk (1000Arms)
751574	Current transducer	DC to 100 kHz (-3dB), 600Apk

* For detailed information, see Power Meter Accessory Catalog Bulletin 7515-52E

* 96001 is a Yokogawa M&C product.

Exterior

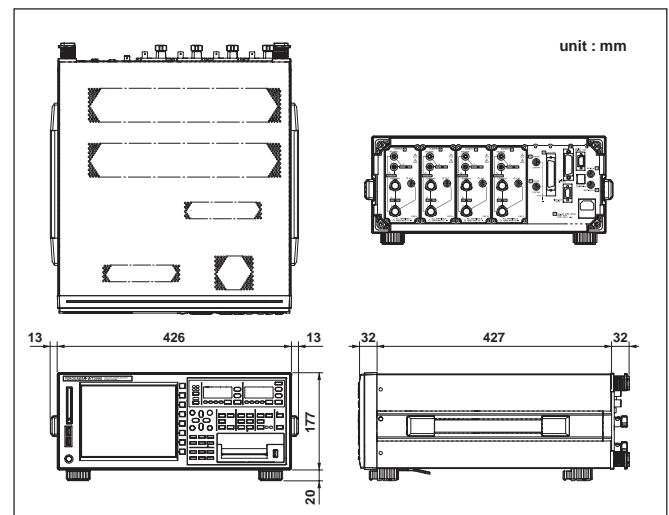

YOKOGAWA

YOKOGAWA ELECTRIC CORPORATION

Communication & Measurement Business Headquarters /Phone: (81)-422-52-6768, Fax: (81)-422-52-6624

E-mail: tm@csv.yokogawa.co.jp

YOKOGAWA CORPORATION OF AMERICA

Phone: (1)-301-916-0409, Fax: (1)-301-916-1498

YOKOGAWA EUROPE B.V.

Phone: (31)-33-4641858, Fax: (31)-33-4641859

YOKOGAWA ENGINEERING ASIA PTE. LTD.

Phone: (65)-62419933, Fax: (65)-62412606

Subject to change without notice.

[Ed : 01/b] Copyright ©2004

Printed in Japan, 411(KP)

MS-14E